

Modular LED signal tower light with built-in terminal

MTG50/ MTC50/ MTR50 Series

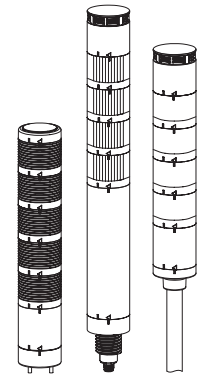

Thank you for purchasing Qlight's products. Please read this user manual carefully prior to installation and operation to ensure safe and correct use.

⚠ Precautions for Safety

Failure to follow the instructions below may cause a loss of life or serious physical injury.

1. During wiring or maintenance, please completely turn off the power of the product. (Failure to follow this may lead to an electric shock.)
2. Do not install the product in locations that subjects it to excessive dust or water other than the conditions designated by the IP protection ratings indicated for each product. (Failure to follow these instructions may cause a fire to the product, electric shock, physical injury, malfunction or damage to the product.)
3. Do not alter or repair this product. If maintenance or repair service is required, please contact your local Qlight contact point. (Failure to follow these instructions may lead to fire, electric shock, or product damage.)
4. Please apply the correct voltage to the product. (Failure to follow these instructions may lead to fire, electric shock, or product damage.)
5. When the product is applied to a condition that may impact lives or property, please make sure to have a double safety device. (Failure to follow this may cause damage to property, fire, electric shock and loss of life.)

⚠ Precautions for Correct Use



Failure to follow the proper instructions may cause damage to property, the product, or malfunction of the product that would void the warranty.

1. Please remove any objects that can interrupt ventilation around the product.
2. Please turn off the power of the product immediately if it fails to operate properly.
3. Carefully wire the product according to each product's specification.
4. Please be careful in preventing chemicals such as thinner, benzene, etc. in contact with the surface of the product.
5. Do not apply excessive force/impact to the product.
6. Failure to follow any of the instructions above may cause malfunction or damage to the product, fire, and electric shock.

Ordering Specifications

• Cover

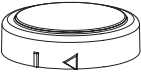
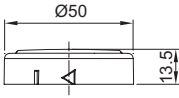
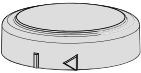
(Units : mm)

Shape	Parts Name	Model No	Color	Common Specifications
	MTG50 cover	MG50-CV	Ivory	<ul style="list-style-type: none"> • Material: ABS • Protection ratings with assemble: IP65 • Product size: Ø50 X 14 
	MTG50 cover	MG50-CV-SV	Silver	
	MTG50 cover	MG50-CV-BK	Black	





Please scan the QR code for more detailed product information.

www.qlight.com

Ordering Specifications

• Buzzer module

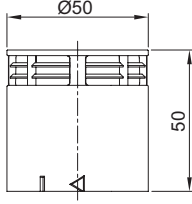

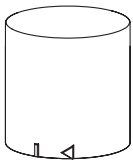
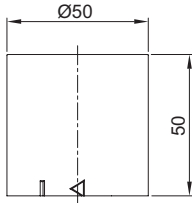
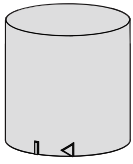
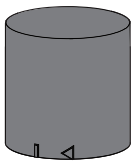
(Units : mm)

Shape	Parts Name	Model No	Color	Specification		Volume(dB)	Common Specifications
				Voltage	Current		
	MTG50-High-volume buzzer module	MG50-HBZ-24	Ivory	DC24V	0.080A	Max.100dB	<ul style="list-style-type: none"> • Material: ABS • Protection ratings with assemble : Non-Waterproof • Product size: Ø50 X 50 
	MTG50-High-volume buzzer module	MG50-HBZ-24-SV	Silver	DC24V	0.080A	Max.100dB	
	MTG50-High-volume buzzer module	MG50-HBZ-24-BK	Black	DC24V	0.080A	Max.100dB	
	MTG50-Waterproof buzzer module	MG50-WBZ-24	Ivory	DC24V	0.080A	Max.85dB	<ul style="list-style-type: none"> • Material: ABS • Protection ratings with assemble: IP65 • Product size: Ø50 X 50 
	MTG50-Waterproof buzzer module	MG50-WBZ-24-SV	Silver	DC24V	0.080A	Max.85dB	
	MTG50-Waterproof buzzer module	MG50-WBZ-24-BK	Black	DC24V	0.080A	Max.85dB	

Ordering Specifications



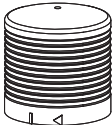
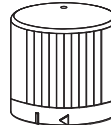

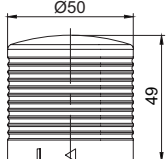
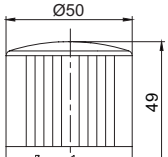
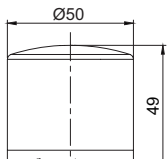

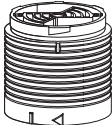

• Cover integrated Lens option is available

(Units : mm)

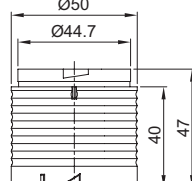
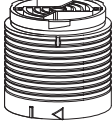
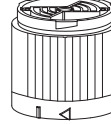
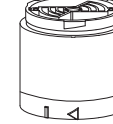
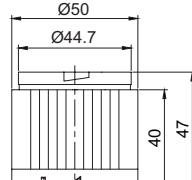
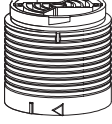
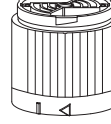
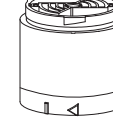
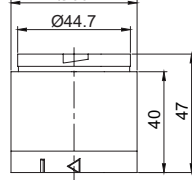
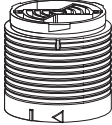
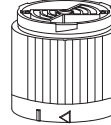
Shape			Model No	Color	Specification		Common Specifications
MG	MC	MR			Voltage	Current	
			MGA50-R-24 MCA50-R-24 MRA50-R-24	Red	DC24V	0.050A	<ul style="list-style-type: none"> • Material: PC • Protection ratings with assemble: IP65 • Product size: Ø50 X 49   

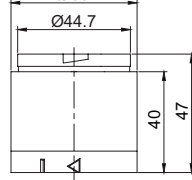
• LED Steady/Flashing Module

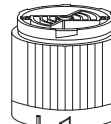

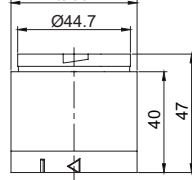

(Units : mm)

Shape			Model No	Color	Specification		Common Specifications
MG	MC	MR			Voltage	Current	
			MG50-R-24 MC50-R-24 MR50-R-24	Red	DC24V	0.050A	<ul style="list-style-type: none"> • Material: PC • Protection ratings with assemble: IP65 • Product size: Ø50 X 47 
			MG50-A-24 MC50-A-24 MR50-A-24	Amber	DC24V	0.050A	
			MG50-G-24 MC50-G-24 MR50-G-24	Green	DC24V	0.050A	
			MG50-B-24 MC50-B-24 MR50-B-24	Blue	DC24V	0.050A	
			MG50-W-24 MC50-W-24 MR50-W-24	White	DC24V	0.050A	

Ordering Specifications

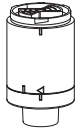
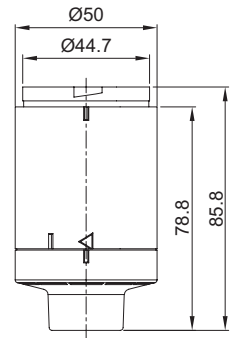
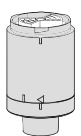
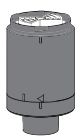
• Base module(Pole mount type)

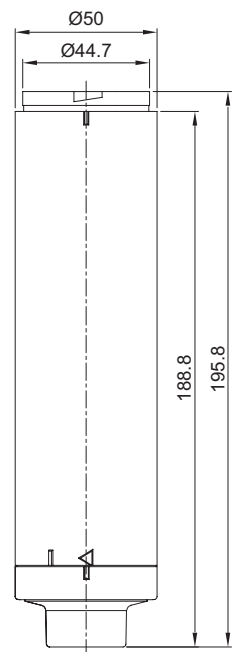
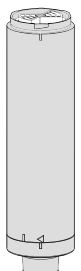



(Units : mm)

Shape	Parts Name	Model No	Color	Specification		Common Specifications
				Voltage	Current	
	MTG50-POLE type base module-DC	MG50-BS-DC	Ivory	DC24V	-	<ul style="list-style-type: none"> • Material: ABS • Protection ratings with assemble: IP65 • Product size: Ø50 X 86 
	MTG50-POLE type base module-DC	MG50-BS-DC-SV	Silver	DC24V	-	
	MTG50-POLE type base module-DC	MG50-BS-DC-BK	Black	DC24V	-	
	MTG50-POLE type base module-AC	MG50-BS-AC	Ivory	AC110-220V	0.035A	<ul style="list-style-type: none"> • Material: ABS • Protection ratings with assemble: IP65 • Product size: Ø50 X 196 
	MTG50-POLE type base module-AC	MG50-BS-AC-SV	Silver	AC110-220V	0.035A	
	MTG50-POLE type base module-AC	MG50-BS-AC-BK	Black	AC110-220V	0.035A	

Ordering Specifications

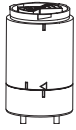
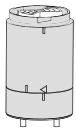
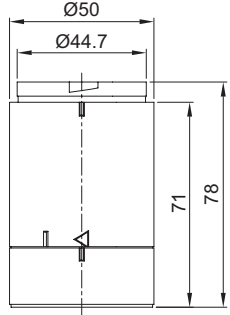
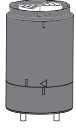
• Base module(Self stand type)

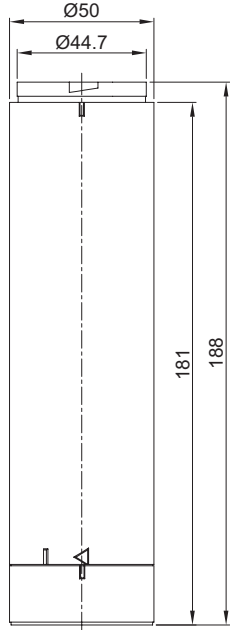



(Units : mm)

Shape	Parts Name	Model No	Color	Specification		Common Specifications
				Voltage	Current	
	MTG50-Self stand base module-DC	MG50-MBS-DC	Ivory	DC24V	-	<ul style="list-style-type: none"> • Material: ABS • Protection ratings with assemble: IP65 • Product size: Ø50 X 78
	MTG50-Self stand base module-DC	MG50-MBS-DC-SV	Silver	DC24V	-	
	MTG50-Self stand base module-DC	MG50-MBS-DC-BK	Black	DC24V	-	
	MTG50-Self stand base module-AC	MG50-MBS-AC	Ivory	AC110-220V	0.035A	
	MTG50-Self stand base module-AC	MG50-MBS-AC-SV	Silver	AC110-220V	0.035A	
	MTG50-Self stand base module-AC	MG50-MBS-AC-BK	Black	AC110-220V	0.035A	

Ordering Specifications

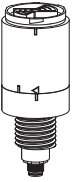
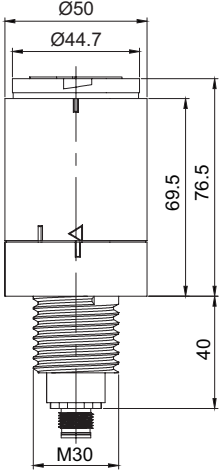
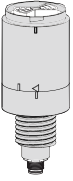
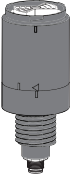
• Base module(M12 CONNECTOR type)

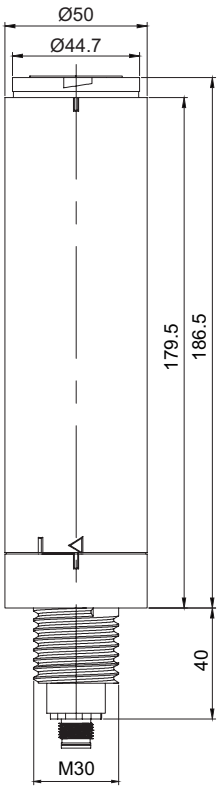
(Units : mm)

Shape	Parts Name	Model No	Color	Specification		Common Specifications
				Voltage	Current	
	MTG50-M12 CONNECTOR type base module- DC	MG50-BS-DC-M12	Ivory	DC24V	-	<ul style="list-style-type: none"> • Material: ABS • Protection ratings with assemble: IP65 • Product size: Ø50 X 77 
	MTG50-M12 CONNECTOR type base module- DC	MG50-BS-DC-M12-SV	Silver	DC24V	-	
	MTG50-M12 CONNECTOR type base module- DC	MG50-BS-DC-M12-BK	Black	DC24V	-	
	MTG50-M12 CONNECTOR type base module- AC	MG50-BS-AC-M12	Ivory	AC110-220V	0.035A	<ul style="list-style-type: none"> • Material: ABS • Protection ratings with assemble: IP65 • Product size: Ø50 X 187 
	MTG50-M12 CONNECTOR type base module- AC	MG50-BS-AC-M12-SV	Silver	AC110-220V	0.035A	
	MTG50-M12 CONNECTOR type base module- AC	MG50-BS-AC-M12-BK	Black	AC110-220V	0.035A	

How to configure module

• Model No/ Shape

• Assembly step

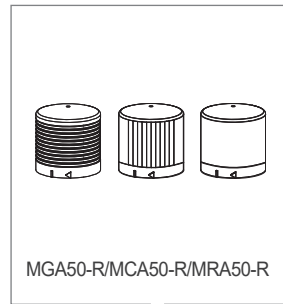
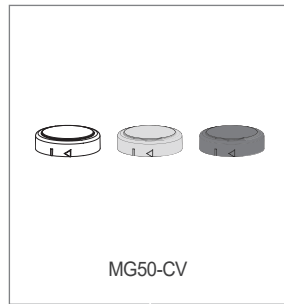
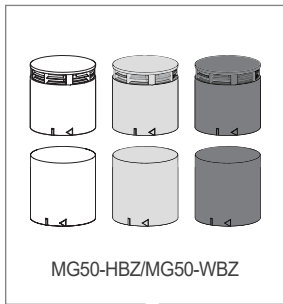

Assembly Step 1

- Choose from cover, buzzer module, and cover lens integrated module
- Please refer to detailed module specification in order to find out model number

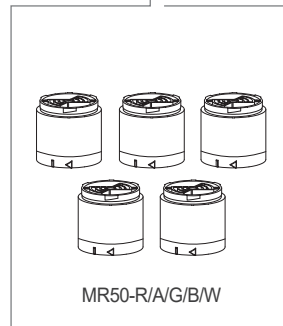
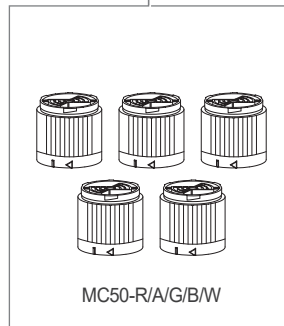
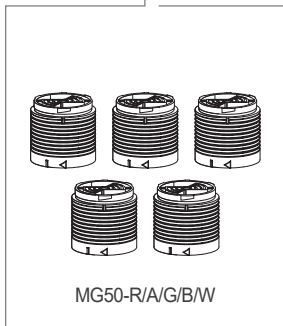

Assembly Step 2

- Select among MTG, MTC, MTR LED module
- When the buzzer module is selected in the first stage of module assembly, only 4 levels of R/A/G/B colors can be used for the LED module (W color cannot be used)
- If the operating voltage is AC type, the LED module uses DC24V type.
- When selecting MTR LED module, please choose black base module
- Please refer to detailed module specification in order to find out model number

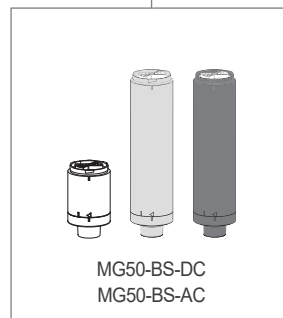
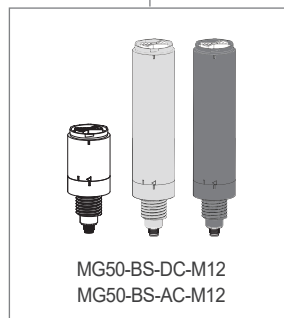
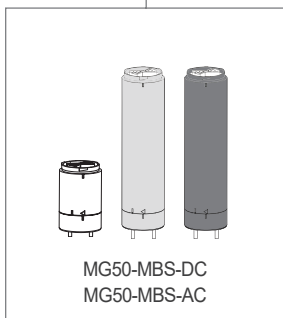

Assembly Step 3

- Please select among direct mount, pole mount, and M12-CONNECTOR type base module
- Please refer to detailed module specification in order to find out model number

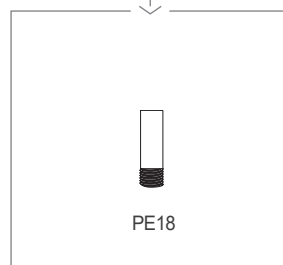
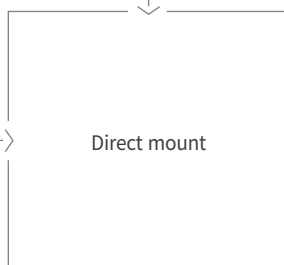

Assembly Step 4

- In case of using POLE type based module at the Assembly Step 3, you should select a pole. The pole can be provided with diverse length.
- Please refer to detailed module specification in order to find out model number

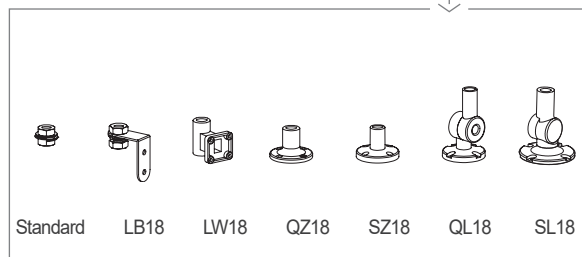
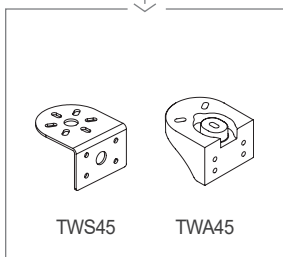

Assembly Step 5

- Please select appropriate mounting bracket in accordance with your needs
- Please refer to detailed module specification in order to find out model number

Wiring Instructions

■ Wiring using external contact

- In case of wiring with external contacts, refer to the wiring diagrams below according to your product's type and voltage setting.

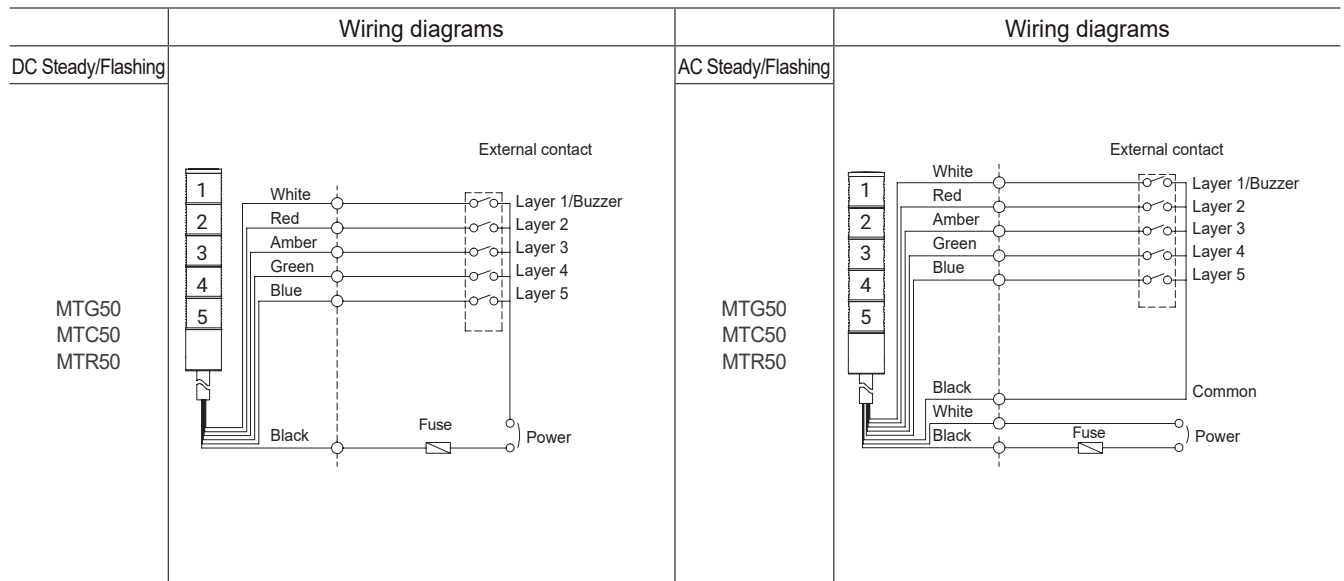

- DC steady type cable specification: External power/ signal line - UL1007 AWG22(0.3sq) 400mm
- AC steady, AC/DC steady/flashing type cable specification : External power line - UL1015 AWG18(0.75sq) × 2C 400mm, External signal line - UL1007 AWG22(0.3sq) 400mm

■ Wiring using transistor

- When using a transistor, please choose between the NPN or PNP type transistor which best matches the voltage and product type, then connect them correctly according to the wiring diagrams below.

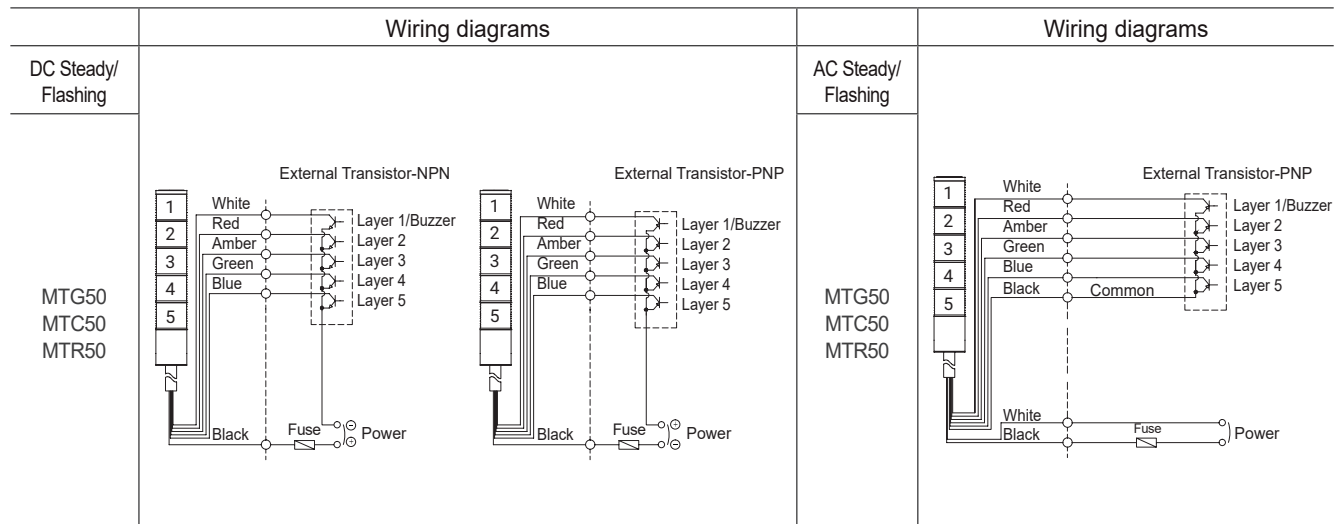

- DC steady type cable specification: External power/ signal line - UL1007 AWG22(0.3sq) 400mm
- AC steady, AC/DC steady/flashing type cable specification : External power line - UL1015 AWG18(0.75sq) × 2C 400mm, External signal line - UL1007 AWG22(0.3sq) 400mm

■ Wiring Instructions

- External power line - UL1015 AWG18(0.75sq) x 2C 400mm
- External signal line - UL1007 AWG22(0.3sq) 400mm
- LED light source tower lamp can be connected using external contacts and transistors

Example of MTG50 module configuration

- You can assemble the product through module combination by referring to the diagram below.
- When a buzzer module (high volume buzzer module/waterproof buzzer module) is combined, only 4 LED modules can be assembled (W color module cannot be assembled).

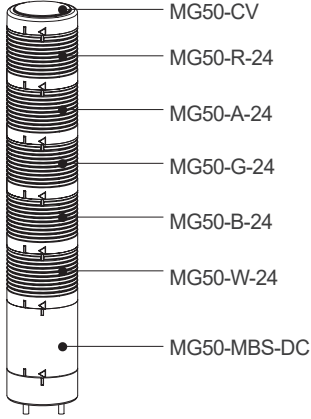
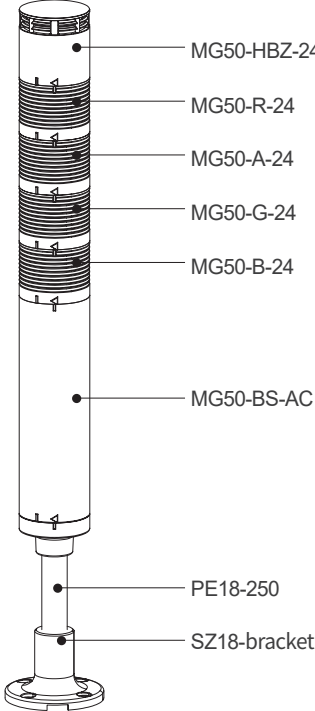
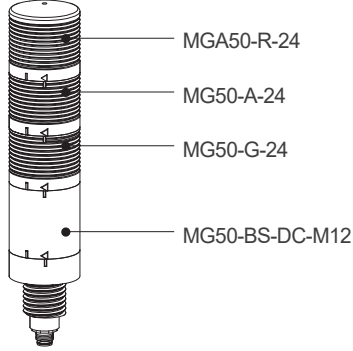
MTG50ML-24-5-RAGBW		MTG50L-HBZ-110/220-4-RAGB-SZ18		MTGA50L-24-3-RAG-M12	
Shape	Modules	Shape	Modules	Shape	Modules
	<ul style="list-style-type: none"> MG50-CV MG50-R-24 MG50-A-24 MG50-G-24 MG50-B-24 MG50-W-24 MG50-MBS-DC 		<ul style="list-style-type: none"> MG50-HBZ-24 MG50-R-24 MG50-A-24 MG50-G-24 MG50-B-24 MG50-BS-AC PE18-250 SZ18-bracket 		<ul style="list-style-type: none"> MGA50-R-24 MG50-A-24 MG50-G-24 MG50-BS-DC-M12
cover module + LED module + MBS module(Self stand type module)		Buzzer module + LED module + BS module(Pole type module) + POLE + Bracket		Cover integrated Lens option LED module + LED module + BS module(M12 CONNECTOR type module)	

Ordering Specifications

MG50-HBZ-24	-	MC50-R/A/G/B-24	-	MG50-BS-AC	-	PE18-250	-	SZ18
[Upper module]		[LED module]		[Base module]		[Pole]		[Bracket]
<ul style="list-style-type: none"> • Cover module • Buzzer module • Cover integrated Lens option is available 		R-Red A-Amber G-Green B-Blue W-White		<ul style="list-style-type: none"> • Pole mount type • Self stand type • M12 CONNECTOR type 		<ul style="list-style-type: none"> • (Blank)None-Self stand type, • M12 CONNECTOR type • POLE type 		<ul style="list-style-type: none"> • (Blank)None-Self stand type, • M12 CONNECTOR type • POLE type, Self stand type(Option)

Example of MTC50 module configuration

- You can assemble the product through module combination by referring to the diagram below.
- When a buzzer module (high volume buzzer module/waterproof buzzer module) is combined, only 4 LED modules can be assembled (W color module cannot be assembled).

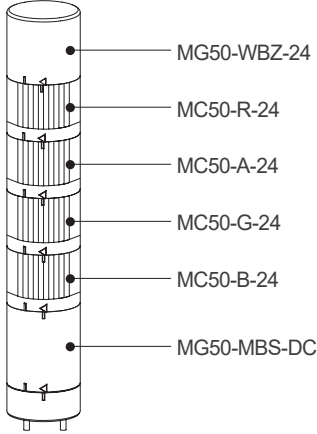
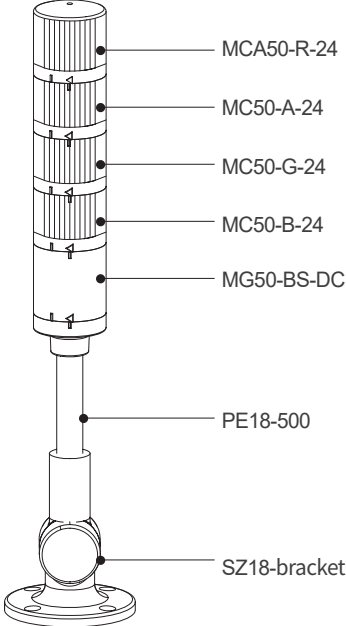
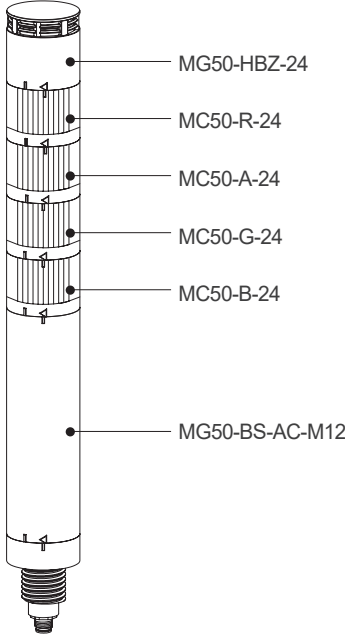
MTC50ML-WBZ-24-4-RAGB		MTCA50L-24-4-RAGB-SZ18		MTC50L-HBZ-110/220-4-RAGB-M12	
Shape	Modules	Shape	Modules	Shape	Modules
					
Buzzer module + LED module + MBS module(Self stand type module)		Cover integrated Lens option LED module + LED module + BS module(Pole type module) + POLE + Bracket		Buzzer module + LED module + BS module(M12 CONNECTOR type module)	

Ordering Specifications

MG50-WBZ	-	MC50-R/A/G/B-24	-	MG50-MBS-DC	-	(Blank)	-	(Blank)
[Upper module]		[LED module]		[Base module]		[Pole]		[Bracket]
<ul style="list-style-type: none"> • Cover module • Buzzer module • Cover integrated Lens option is available 		R-Red A-Amber G-Green B-Blue W-White		<ul style="list-style-type: none"> • Pole mount type • Self stand type • M12 CONNECTOR type 		<ul style="list-style-type: none"> • (Blank)None-Self stand type, • M12 CONNECTOR type • POLE type 		<ul style="list-style-type: none"> • (Blank)None-Self stand type, • M12 CONNECTOR type • POLE type, Self stand type(Optional)

Example of MTR50 module configuration

- You can assemble the product through module combination by referring to the diagram below.
- When a buzzer module (high volume buzzer module/waterproof buzzer module) is combined, only 4 LED modules can be assembled (W color module cannot be assembled).

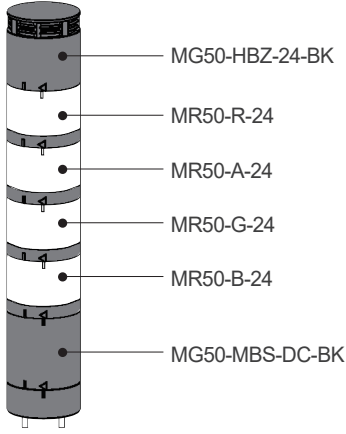
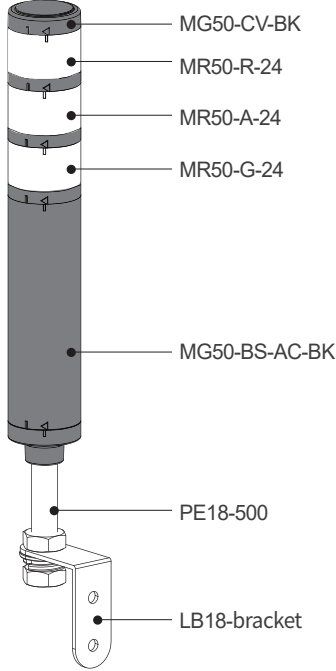
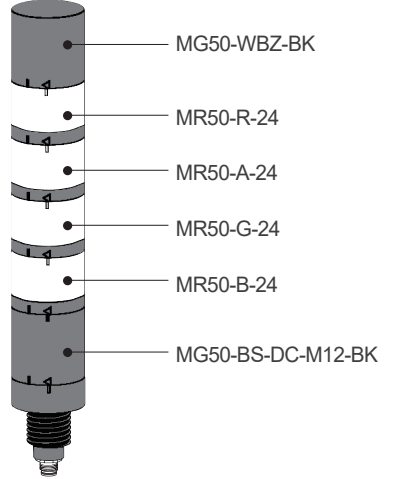
MTR50ML-HBZ-24-4-RAGB-BK		MTR50L-110/220-3-RAG-LB18-BK		MTR50L-WBZ-24-4-RAGB-M12-BK	
Shape	Modules	Shape	Modules	Shape	Modules
					
Buzzer module-Black + LED module + MBS module-Black (Self stand type module)		cover module-Black + LED module + BS module-Black(Pole type module) + POLE + Bracket		Buzzer module-Black + LED module + BS module-Black (M12 CONNECTOR type module)	

Ordering Specifications

MG50-CV-BK	-	MR50-R/A/G/B/W-24	-	MG50-BS-AC-BK	-	PE18-500	-	LB18
[Upper module]		[LED module]		[Base module]		[Pole]		[Bracket]
<ul style="list-style-type: none"> • Cover module • Buzzer module • Cover integrated Lens option is available 		<ul style="list-style-type: none"> R-Red A-Amber G-Green B-Blue W-White 		<ul style="list-style-type: none"> • Pole mount type • Self stand type • M12 CONNECTOR type 		<ul style="list-style-type: none"> • (Blank)None-Self stand type, M12 CONNECTOR type • POLE type 		<ul style="list-style-type: none"> • (Blank)None-Self stand type, M12 CONNECTOR type • POLE type, Self stand type(Optional)

How to Change Lens Kit

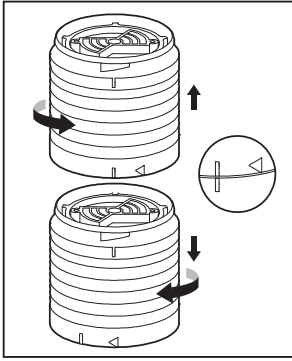

- Disassembling lens kits
- ① Twist the upper lens kit in a counter-wise direction so the "I" mark from both kits align.
 - ② Disassemble by removing the upper lens kit from the lower one.

※ Cautions

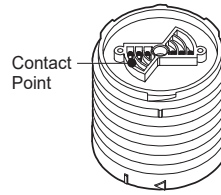

Lens modules are connected through cone-shaped contact point. In case the contact point is damaged, it may cause a contact failure.

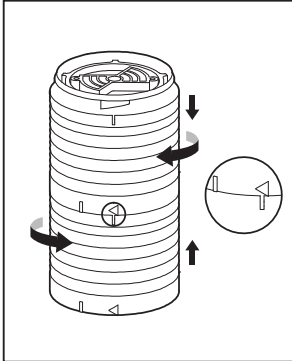

- Assembling lens kits
- ① Put the two lens kits together by aligning the upper lens' "I" mark and the lower lens' "I" mark together.
 - ② Lock the two kits by twisting the upper lens kit in a counter-wise direction so the upper lens' "I" mark aligns with the lower lens' "I" mark.

Mounting Hole Specifications

■ MTG50 Self stand base module DC/ Self stand base module AC

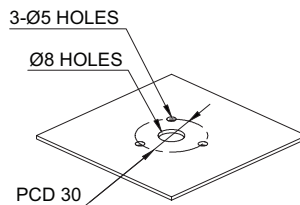

- ① Machine holes on the mounting surface referring to the diagram below.
- ② Remove the flange nuts from bolts and place the product through the mounting surface holes.
- ③ Fasten the flange nuts on the opposite side of the mounting surface until the product is tightened securely.

Installation Environment and Protection Rating

- This product is designed for indoor use with protection rating of Non-Waterproof(High-volume buzzer type)/ IP65(Waterproof buzzer type).
- If the product is installed in locations that subject it to excessive dust or water other than the designated IP protection rating indicated(IP65), it may cause malfunction or damage to the product.
- For further information, please visit our website(www.qlight.com).

Mounting Accessories (Sold Separately)

• Please refer to the dimensions below for installation of mounting brackets.

■ MTG50 Self stand base module DC/ module AC

		Dimensions	
MTG50 MTC50 MTR50	<p>TWS45</p>	<p>TWA45</p>	

Mounting Accessories (Sold Separately)

■ MTG50-Pole mount type module DC/ module AC

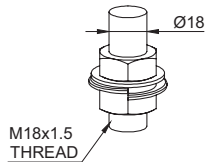
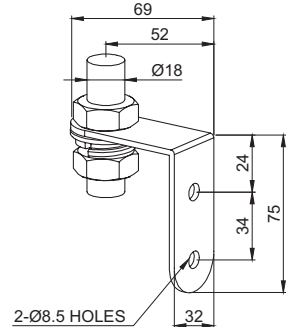
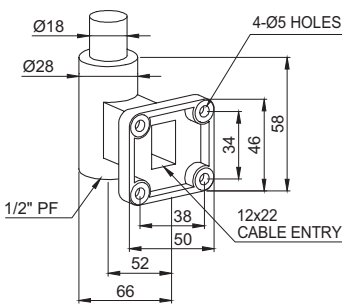
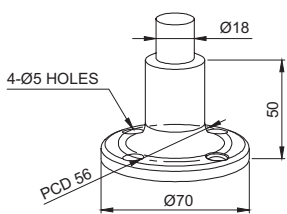
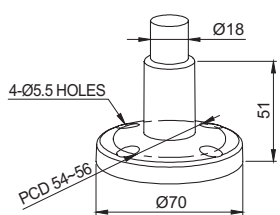
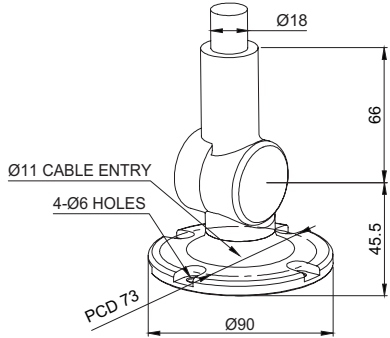
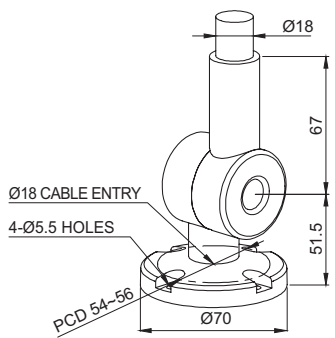
		Dimensions	
MTG50 MTC50 MTR50	 <p>M18x1.5 THREAD</p> <p>Ø18</p>	 <p>69 52 Ø18 24 34 75 32 2-Ø8.5 HOLES</p>	<p>18mm SCREW & NUT</p> <p>LB18</p>
	 <p>Ø18 Ø28 4-Ø5 HOLES 1/2" PF 34 46 58 38 50 12x22 CABLE ENTRY 52 66</p>	 <p>Ø18 4-Ø5 HOLES PCD 56 Ø70 50</p>	<p>LW18</p> <p>SZ18</p>
	 <p>Ø18 4-Ø5.5 HOLES PCD 54-56 Ø70</p>	 <p>Ø18 Ø11 CABLE ENTRY 4-Ø6 HOLES PCD 73 Ø90 66 45.5</p>	<p>QZ18</p> <p>SL18</p>
	 <p>Ø18 Ø18 CABLE ENTRY 4-Ø5.5 HOLES PCD 54-56 Ø70 67 51.5</p>		<p>QL18</p>

Product installation direction

- Install the product in accordance with the manual. Otherwise rainwater or moisture may penetrate into the product.

· BEACON/SIGNALING LIGHT

※ For products with a protection rating of less than IPX4, please install it vertically.

Power cord inlet part shall not be facing the sky.

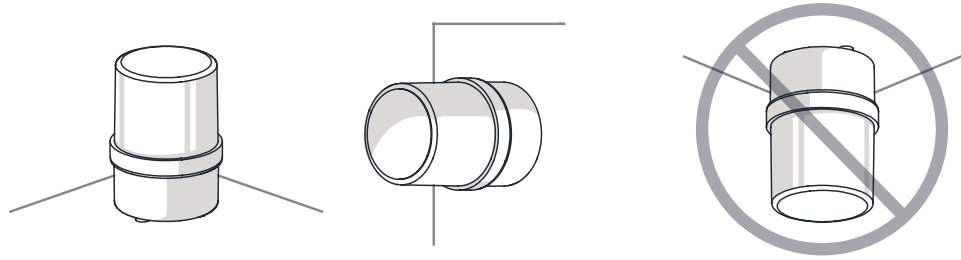

· ELECTRONIC SOUNDER/SIGNAL HORN

Sounder part shall not be facing the sky.

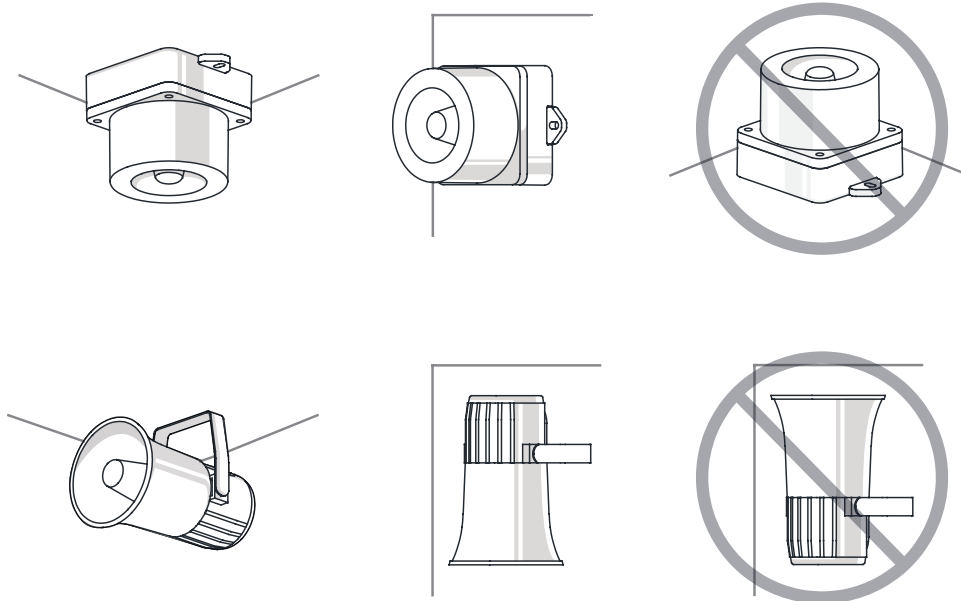

· HEAVY-DUTY & EXPLOSION PROOF SIGNALINGS

Sounder part shall not be facing the sky.

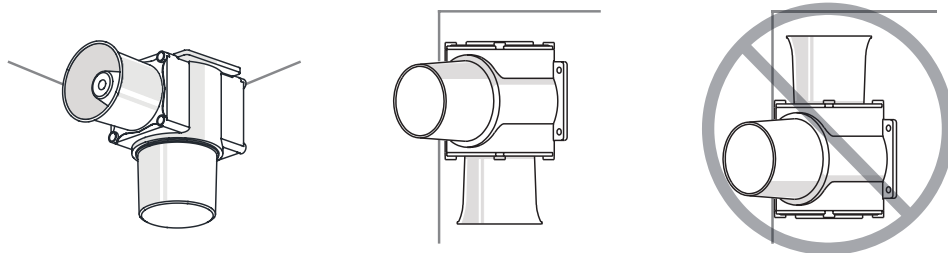

· SIGNAL TOWER LIGHTS

※ For products with a protection rating of less than IPX4, please install it vertically.

Power cord inlet part shall not be facing the sky.

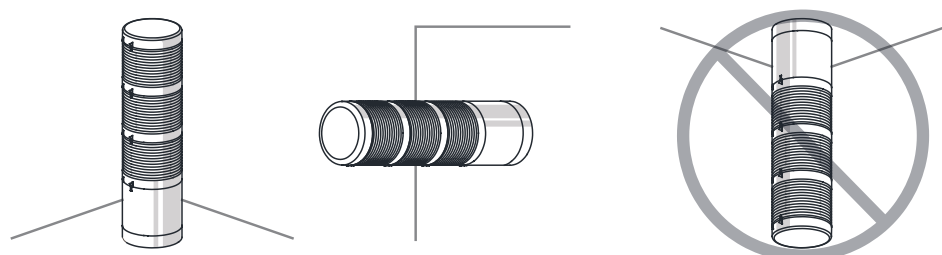



For your safety

Specification and dimensions listed in this catalogue subject to change without notice for product quality improvement.
The newest product information is available on our website.(www.qlight.com)
Please read the instruction manual attached to the product carefully before installation and use.

Qlight Co., Ltd. www.qlight.com | trade@qlight.com

Head Office | Suite #1510, STX-V Tower, 128 Gasan digital 1-ro, Geumcheon-gu, Seoul, Korea

Tel. +82-2-2679-6152(Toll free. +82-80-328-2222) Fax. +82-2-2679-6154

Factory | 185-25, Mukbang-ro, Sangdong-myeon, Gimhae-si, Gyeongsangnamdo, Korea Tel. +82-55-328-1111(Toll free. +82-80-328-1111)

Qlight OverSEAs Sales Dept | 704 Nakdong-daero, Sasang-gu, Busan, Korea(Eomgung-Dong) Tel : +82-51-620-4100

Qlight Public Relations & Marketing Team Office | 704 Nakdong-daero, Sasang-gu, Busan, Korea(Eomgung-Dong) Tel. +82-51-245-0017

Qlight USA, Inc. www.qlight.com www.qlightusa.com | sales@qlightusa.com

3003 North First Street, Suite #341, San Jose, CA 95134 USA Tel. +1-408-519-5740 Fax. +1-408-519-5739

SHANGHAI Qlight Electronic Co., Ltd. www.qlight.com www.qlightcn.com | qlightcn@qlight.com

China Factory/ Shanghai Sales Office | #19, Nanda Road, Baoshan Area, Shanghai, China Tel. +86-21-6651-7100 Fax. +86-21-6315-3929

China Factory Site 2 (Qidong) | #33, Haiyan Road, Qidong High-tech Industrial Development Zone, Qidong, Jiangsu Province, China

Tel +86-513-8384-9999 Fax +86-513-8384-9910

Qlightec

Innovation in Alarm & Signal

Product Operation Inquiry / Customer Support +82-51-620-4100

You can expect prompt service if you have exact information such as model name, symptom, telephone number and address.

※ ALL PRODUCT, PRODUCT SPECIFICATIONS AND DATA ARE SUBJECT TO CHANGE WITHOUT NOTICE TO IMPROVE RELIABILITY, FUNCTION OR DESIGN OR OTHERWISE.

Head office : Suite #1510, STX-V Tower, 128 Gasan digital 1-ro, Geumcheon-gu, Seoul, Korea (Postal Code : 08507)

Factory : 185-25, Mukbang-Ro, Sangdong-Myeon, Gimhae-Si, Gyeongsangnam-Do, Korea (Postal Code : 50805)

www.qlight.com

EN - MTG50 - 2302A