



Bonfiglioli

Vectron

Active Cube

Servo Drive Solutions



Bonfiglioli

power, control and green solutions

Power, control and green solutions



Bonfiglioli, one name for a large international group

It was back in 1956 that Clementino Bonfiglioli established in Bologna, Italy, the company that still bears his name. Now, some fifty years later, the same enthusiasm and dedication is driving Bonfiglioli to become the world's top name in power transmission and control solutions. Through directly controlled subsidiaries and production plant around the world, Bonfiglioli designs, manufactures and distributes a complete range of gearmotors, drive systems and planetary gearboxes, and boasts the most integrated offering on the market today.

Now, to emphasise its commitment to health, safety and environmental sustainability, Bonfiglioli is adding the term "green" to the description of its offering.

This commitment can be seen too in the Group's new trademark, made up of three shapes and colours identifying Bonfiglioli's three main business areas - Power, Control & Green Solutions and symbolising a set of values that includes openness and respect for other cultures.

In a market in which excellent product quality alone is no longer sufficient, Bonfiglioli also provides experience, know-how, an extensive sales network, excellent pre-sales and after-sales service and modern communication tools and systems to create high level solutions for industry, mobile machinery and renewable energy.

Bonfiglioli solutions

wind



industrial

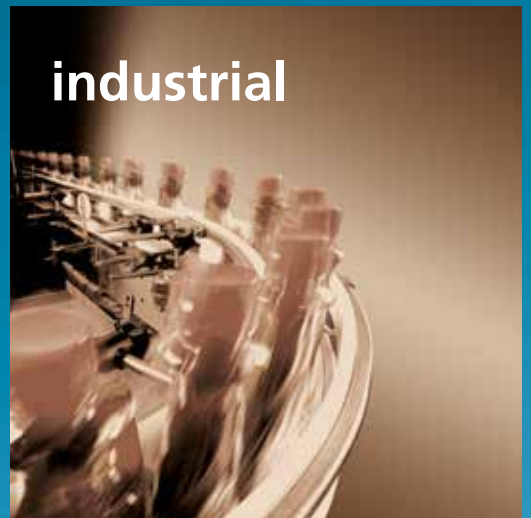

mobile

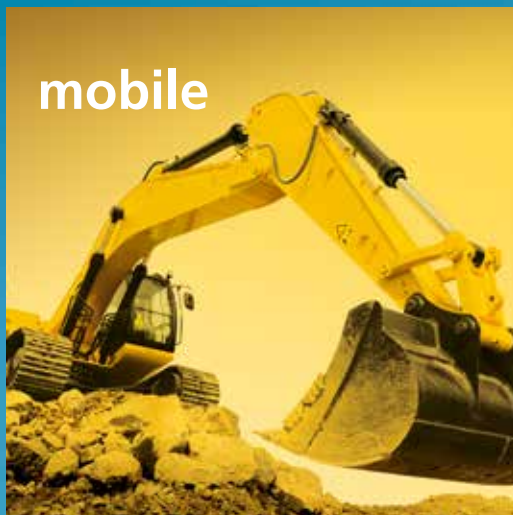

photovoltaic



Innovative solutions for industrial field.

Bonfiglioli Riduttori today is one of the top brands in the power transmission industry. The company's success is the result of a business strategy that relies on three fundamental factors: know-how, innovation and quality. The complete range of Bonfiglioli brand gearmotors offers excellent technical characteristics and guarantees the highest performance. Substantial investment and technical expertise have enabled the company to achieve an annual production output of 1600000 units using completely automated processes.

Certification of the company's Quality System by DNV and TÜV is proof of the high quality standards achieved.

With the acquisition of the Vectron brand, Bonfiglioli is now established as leader of the industrial automation sector.

Bonfiglioli Vectron delivers products and services for completely integrated inverter solutions. These solutions complement Bonfiglioli's power transmission and control offering to the industrial sector.

Since 1976, Bonfiglioli Trasmital's know-how in the power transmission industry has focused on special applications offering 100% reliability in the manufacturing of gearmotors for mobile machinery.

This includes the full range of slew and wheel drive applications and gearboxes for wind turbine pitch and yaw drive systems.

Today Bonfiglioli Trasmital stands at the forefront of the industry as a key partner to top manufacturers worldwide.



Servo Drive Solutions



Advanced technologies for all industrial fields.

The Bonfiglioli Active Cube series is designed to enable you to maximize the opportunities in machine automation.

Extensive motor controls and functionality allow Active Cube to be used in the design of effective and easy automation solutions for a wide variety of industrial machinery and plants.

Outstanding performance in terms of accuracy and response time put Active Cube in the high technology end of the Bonfiglioli Vectron drives range.

The range includes both 1phase and 3phase units, 230V and 400V supply, with the 3 phase product available up to 132kW.

Active Cube includes many features making it suitable for universal use, both as an effective "System drive", and also as a "Servo drive", able to fulfil the requirements of the majority of motion control applications.

Integrated and extensive logic functions give to Active Cube users the possibility to easily and effectively re-arrange drive routines. Brand new functionality can be utilized to tailor the drive to their specific control needs, thus achieve optimal solutions.

Process and machine safety needs are catered for in Active Cube, thanks to the "safe oriented" functions included in the standard drive.

Communication with programmable logic controllers, PC's and industrial display systems is ensured by the wide set of Fieldbus protocols available, while the Bonfiglioli proprietary System bus network allows extremely fast and reliable dialogue for synchronization and/or data exchange with other Bonfiglioli drives in the system.

When considering "servo" applications, Active Cube benefits from the full compatibility with the extensive program of Bonfiglioli synchronous servomotors and accessories (BTD and BCR series), which together provide the possibility of a total Bonfiglioli "servo system".

VPlus engineering and configuration software includes advanced and effective tools for diagnostics and troubleshooting: real oscilloscope analyzer, variable monitoring window; and dashboard for most important process measures are just a few examples.

Technical support is a key element in the Active Cube program, therefore your local Bonfiglioli Drive Service Centre is at your disposal to help and support your engineering department during machine and system requirements analysis, control system architecture definition, product selection and dimensioning, commissioning and start up.

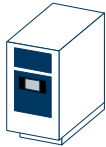
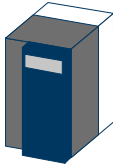
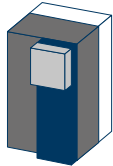
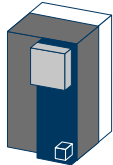
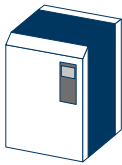

Bonfiglioli drive power/control range

Power range		
[kW]		
	Synthesis	0.2 ... 2.2
	Agile	0.25 ... 11
	Active	0.55 ... 132
	Active Cube	0.25 ... 132
	VCB	65 ... 355

Bonfiglioli "system" range

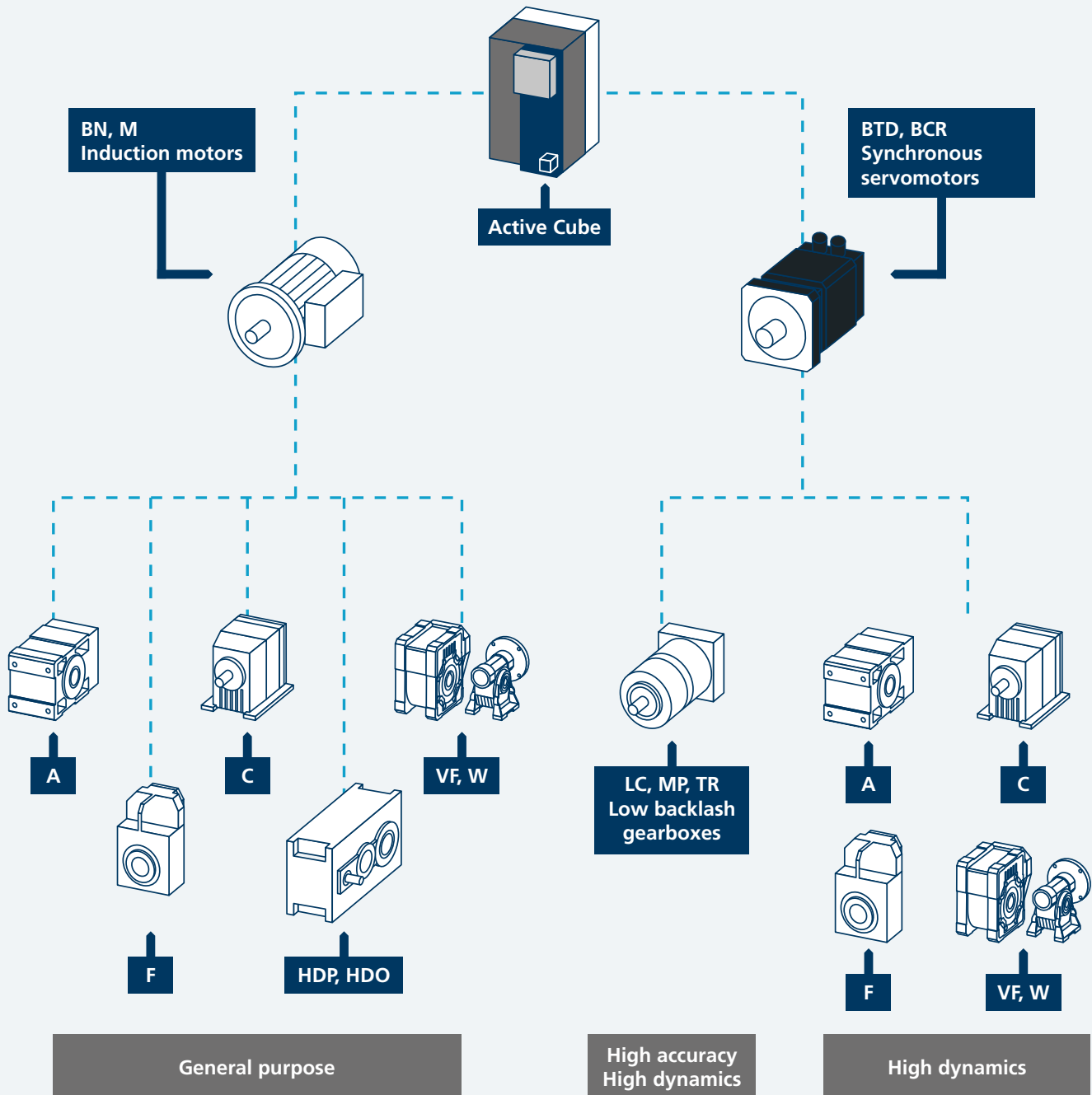

The designation of ACU201 series

Designation ACU201 series

Basic variants

ACU 201	13	F	A
			<p>Construction style A style with standard cooling</p>
		<p>EMI filter F internal filter (blank) no internal filter</p>	
	<p>Size 1 01 0.25 kW 03 0.37 kW 05 0.55 kW 07 0.75 kW 09 1.1 kW</p> <p>Size 2 11 1.5 kW 13 2.2 kW 15 3.0 kW (only 3 ph)</p> <p>Size 3 18 4.0 kW (only 3 ph) 19 5.5 kW (only 3 ph)</p> <p>Size 4 21 7.5 kW (only 3 ph) 22 9.2 kW (only 3 ph)</p>		

Series

- ACU 201 inverter ACTIVE CUBE 1ph/3ph x 200-240 VAC +/- 10%

Optional variants

MPSV	EMSYS	CMCAN	KP500
			<p>User interface (blank) no user interface KP500 programming control unit KP232 RS232 serial interface</p>
		<p>Communication modules (blank) no module CM-CAN CANopen interface CM-PDP Profibus DP interface CM-232 RS232 interface CM-485 RS485 interface CM-DEV DEVICENET interface CM-EtherCAT EtherCAT® interface CM-ProfiNet PROFINET interface CM-VABus/TCP Ethernet VA BUS TCP interface</p>	
	<p>Expansion modules (blank) no expansion modules EM-SYS SYSTEMBUS expansion module EM-IO-... (01, 02, 03, 04) I/O expansion modules EM-ENC-... (01, 02, 03, 04, 05) ENCODER expansion modules EM-RES-... (01, 02, 03) RESOLVER expansion modules EM-ABS-... (01) Absolute encoder module</p>		
	<p>Mounting kit (blank) standard panel mounting kit MPSV thru-type mechanical installation kit without fan MDIN DIN rail mechanical installation kit MNVIB antivibration mechanical installation kit</p>		

The designation of ACU401 series

Designation ACU401 series

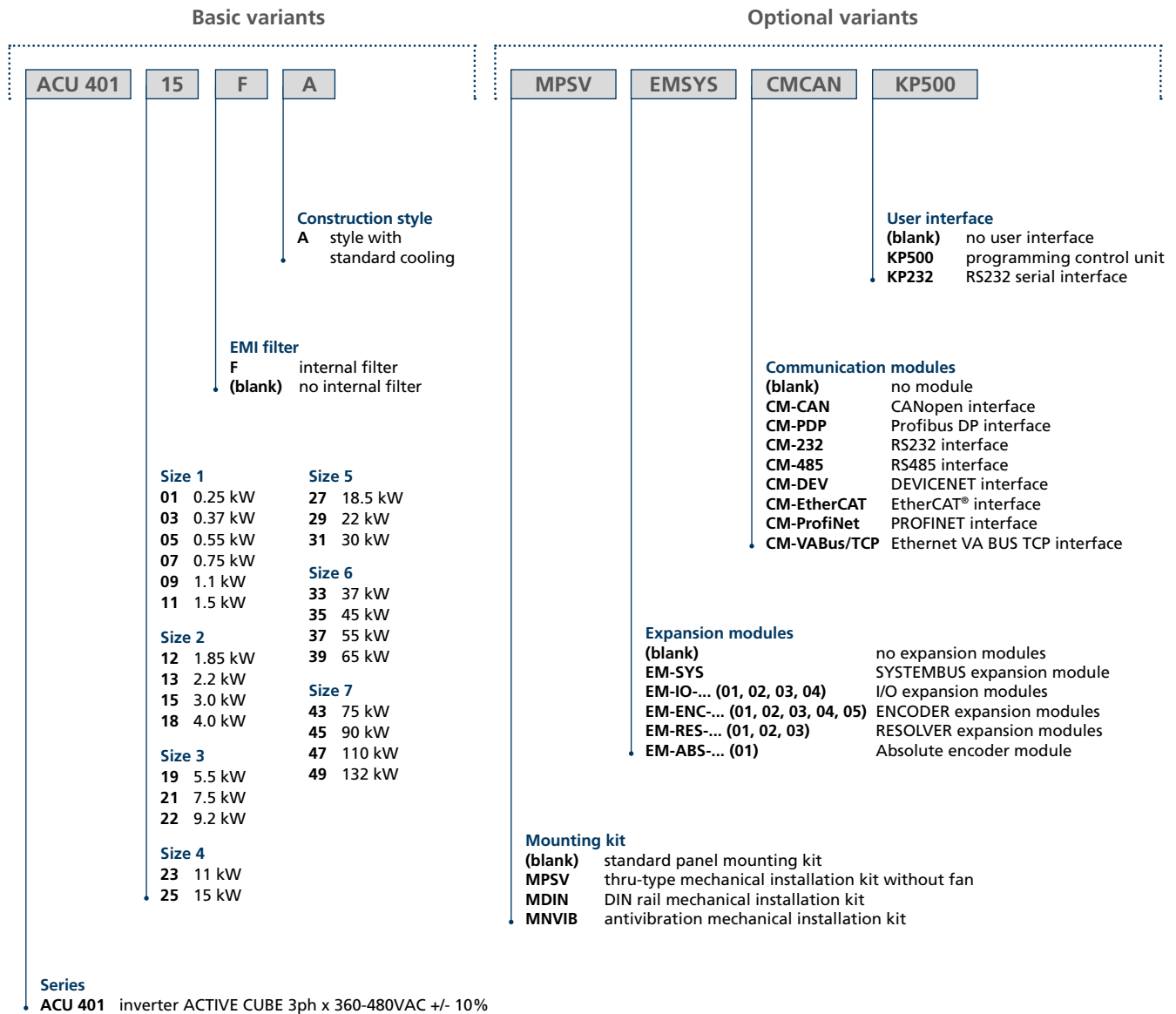

Hardware

Performance

- High speed control loop and fast response time
- Both "system drive" and "servo drive"
- Optimized combination with Bonfiglioli BTM and BCR servomotor series

Automation

- Small dimensions and "power density" in all sizes
- "Book shape" in smaller sizes for easy integration in automation cabinets
- Integrated "safe Torque Off" function, according to EN954-1 cat.3
- External 24V supply input for control board supply from backup systems
- Motor thermal evaluation
- Position and speed feedback input (encoder/resolver)
- Several mechanical mounting modes available: Din rail mounting, pass through mounting, side mounting
- Proprietary fieldbus (System bus) for fast communication among Bonfiglioli Active Cube drives

Electrical

- Plug in control terminals for easy and fast connection
- Plug in power terminals up to 4kW
- DC link bus for "energy sharing" in multidrive system architectures
- Integral EMI filters (EN 61800-3) up to 9,2kW
- Integrated brake transistor on all sizes

Options and accessories

- Comprehensive set of optional expansion modules, to greatly increase the I/Os and feedback acquisition of the basic equipment
- Comprehensive set of optional communication modules, to connect Active Cube to control devices using traditional industry fieldbus communication protocols and ethernet based ones
- Multifunction keypad with monitoring and programming functions
- Drive-PC connection kit for advanced configuration with engineering software VPlus
- Teleservice kit for remote diagnosis and maintenance
- Comprehensive power and control cable packs for fast and easy connection of Active Cube to Bonfiglioli BTM and BCR servomotors

Software

Flexibility

- Control both of asynchronous and synchronous actuators
- Full set of operation modes, freely selectable:
 - Servo synchronous control with resolver feedback
 - Field oriented (vector) control with absolute encoder speed/sensor
 - Sensorless field oriented (vector) control
- Flexible assignment of digital inputs and outputs to control software module variables
- "Motor chopper" function to increase braking power without brake resistors
- 4 independent data sets
- Flying restart

Automation

- Easy and powerful engineering software for parameter setting, diagnostic and aided commissioning
- Integrated powerful logic functions
- Speed and position synchronization between drives through Systembus
- Master/slave operation
- Electronic gear
- PI control with advanced derivative control
- Intelligent current limits
- Motor potentiometer control via digital input, control unit and communication interface

Servo

- Very accurate and reliable speed and position control
- Integrated motion software including homing functions, units converter, programmable motion blocks, to design and test even complex motion profiles
- Rotary table function
- S-ramps selection with separate adjustable acceleration/deceleration and jerk limitation
- Preset values for Bonfiglioli BTD/BCR

servomotors

Safety

- Mains voltage monitoring and "bridging" function to overcome short time power failures
- Overload protection and best switching frequency automatic adjustment
- Safe Torque Off function

Diagnosis

- Phase monitoring
- Mean and peak values storage

Advanced application functions

- Advanced brake release control (lifting applications)
- Spindle control up to 1000Hz with "tool change" positioning
- "Traverse" function for winders
- "Index" function for enhanced sensorless synchronization
- Load detection function

Engineering software

- Easy programming interface
- Real time oscilloscope and variable values monitor for enhanced troubleshooting analysis during the commissioning phase
- Effective and easy management of motion block parameters
- A simple and guided procedure for set up with Bonfiglioli servomotors
- Logic function programming section with 16 functions

General technical data

Environment

Operating temperature

- 0°C - 40°C (40°C - 55°C with derating)

Environment class

- Operation 3K3 (EN60721-3-3)
- Relative humidity 15% ... 85%, no moisture condensation

Altitude of installation

- Up to 1000m (up to 4000 with derating)

Storage conditions

- According to EN50178

Protection degree

- IP20

Electrical

Rated mains voltage

- ACU 201 in the range 184 ... 264 V
ACU 401 in the range 320 ... 528 V

Rated mains frequency

- 45 ... 66 Hz

Overload current

- 150% of rated current (200% for 0.25 and 0.37 kW)

Peak current

- 200% of rated current for most ratings

Electric protection

- Short circuit / Earth fault proof

Braking transistor

- Built-in on standard devices

Standards

CE conformity:

- Low voltage directive 73/23/EEC and EN50178 / DIN VDE 0160 and EN61800

Interference immunity

- According to EN 61800-3 for use in industrial environments

UL approval

- UL marked, according to UL508c

ACU201 - Technical data (from 0.25 to 3.0 kW)

ACU201-			01	03	05	07	09	11	13	15	
			Size 1 (F, A)					Size 2 (F, A)			
Output, motor side											
Rated motor current output	I_n	A	1.6	2.5	3.0	4.0	5.5	7.0	9.5	12.5	
Rated motor voltage output	U_n	V	3 x (from 0 to mains voltage)								
Overload current	I_{pk}	A	3.2	5.0	4.5	6.0	7.3	10.5	14.3	16.2	
Recommended rated motor power	P_n	kW	0.25	0.37	0.55	0.75	1.1	1.5	2.2	3.0	
Switching frequency	f_c	kHz	From 2 to 6								
Rated motor frequency	f_n	Hz	From 0 to 1000								
Input, mains side											
Rated mains voltage	U	V	184 ... 264								
Rated mains frequency	F	Hz	45 ... 66								
Rated current 3 ph/PE	I	A	1.6	2.5	3.0	4.0	5.5	7.0	9.5	10.5	
Rated current 1 ph/N/PE; 2 ph/PE	I	A	2.9	4.5	5.4	7.2	9.5	13.2	16.5	16.5	
General											
Short circuit / ground fault protection	-	-	Yes, unlimited								
Mounting position	-	-	Vertical								
Protection class	-	-	IP 20 (EN60529)								
Dimensions Std. A	HxWxD	mm	190 x 60 x 175					250 x 60 x 175			
Weight (approx.)	m	kg	1.2					1.6			
Brake unit	-	-	Internal brake transistor								
Environment											
Cooling temperature	T_n	°C	From 0 to 40 (3K3 DIN IEC 721-3-3)								
Relative air humidity	-	%	From 15 to 85, non-condensing								
Options & accessories											
Input line choke	-	-	External (depending on mains supply)								
EMI filter	-	-	Internal Class A (EN 61800-3); external Class B								
Digital control unit	-	-	yes								

ACU201 - Technical data (from 4.0 to 9.2 kW)

ACU201-			18	19	21	22
			Size 3 (- or F, A)		Size 4 (-, A)	
Output, motor side						
Rated motor current output	I_n	A	18.0	22.0	32.0	35.0
Rated motor voltage output	U_n	V	3 x (from 0 to mains voltage)			
Overload current	I_{pk}	A	26.2	30.3	44.5	51.5
Recommended rated motor power	P_n	kW	4.0	5.5	7.5	9.2
Switching frequency	f_c	kHz	From 2 to 6			
Rated motor frequency	f_n	Hz	From 0 to 1000			
Input, mains side						
Rated mains voltage	U	V	184 ... 264			
Rated mains frequency	f	Hz	45 ... 66			
Rated current 3 ph/PE	I	A	18	20	28.2	35.6
Mains fuses 3 ph/PE	I	A	25		35	50
General						
Short circuit / ground fault protection	-	-	Yes, unlimited			
Mounting position	-	-	Vertical			
Protection class	-	-	IP 20 (EN60529) ⁽⁰⁾			
Dimensions Std. A	HxWxD	mm	250 x 100 x 200		250 x 125 x 200	
Weight (approx.)	m	kg	3.0		3.7	
Brake unit	-	-	Internal brake transistor			
Environment						
Cooling temperature	T_n	°C	From 0 to 40 (3K3 DIN IEC 721-3-3)			
Relative air humidity	-	%	From 15 to 85, non-condensing			
Options & accessories						
Input line choke	-	-	External (depending on mains supply)			
EMI filter	-	-	Internal Class A (EN 61800-3); External Class B			
Digital control unit	-	-	Yes			

Note: (0) = for protection classes higher than IP20 consult your local Bonfiglioli Drives Service Center

ACU401 - Technical data (from 0.25 to 3.0 kW)

ACU401-			01	03	05	07	09	11	12	13	15	
			Size 1 (F, A)						Size 2 (F, A)			
Output, motor side												
Rated motor current output	I_n	A	1.0	1.6	1.8	2.4	3.2	3.8	4.2	5.8	7.8	
Rated motor voltage output	U_n	V	3 x (from 0 to mains voltage)									
Overload current	I_{pk}	A	2.0	3.2	2.7	3.6	4.8	5.7	6.3	8.7	11.7	
Recommended rated motor power	P_n	kW	0.25	0.37	0.55	0.75	1.1	1.5	1.85	2.2	3.0	
Switching frequency	f_c	kHz	From 2 to 16									
Rated motor frequency	f_n	Hz	From 0 to 1000									
Input, mains side												
Rated mains voltage	U	V	320 ... 528									
Rated mains frequency	f	Hz	45 ... 66									
Rated current 3 ph/PE	I	A	1.0	1.6	1.8	2.4	2.8	3.3	4.2	5.8	6.8	
Mains fuses 3 ph/PE	I	A	6						10			
General												
Short circuit / ground fault protection	-	-	Yes, unlimited									
Mounting position	-	-	Vertical									
Protection class	-	-	IP 20 (EN60529) ⁽⁰⁾									
Dimensions Std. A	HxWxD	mm	190 x 60 x 175						250 x 60 x 175			
Weight (approx.)	m	kg	1.2						1.6			
Brake unit	-	-	Internal brake transistor									
Environment												
Cooling temperature	T_n	°C	From 0 to 40 (3K3 DIN IEC 721-3-3)									
Relative air humidity	-	%	From 15 to 85, non-condensing									
Options & accessories												
Input line choke	-	-	External (depending on mains supply)									
EMI filter	-	-	Internal Class A (EN 61800-3); External Class B									
Digital control unit	-	-	Yes									

Note: (0) = for protection classes higher than IP20 consult your local Bonfiglioli Drives Service Center

ACU401 - Technical data (from 4.0 to 15 kW)

ACU401-			18	19	21	22	23	25	
			Size 2 (F, A)		Size 3 (- or F, A)		Size 4 (-, A)		
Output, motor side									
Rated motor current output	I_n	A	9.0	14.0	18.0	22.0	25.0	32.0	
Rated motor voltage output	U_n	V	3 x (from 0 to mains voltage)						
Overload current	I_{pk}	A	13.5	21.0	26.3	30.3	37.5	44.5	
Recommended rated motor power	P_n	kW	4.0	5.5	7.5	9.2	11.0	15.0	
Switching frequency	f_c	kHz	From 2 to 16						
Rated motor frequency	f_n	Hz	From 0 to 1000						
Input, mains side									
Rated mains voltage	U	V	320 ... 528						
Rated mains frequency	f	Hz	45 ... 66						
Rated current 3 ph/PE	I	A	7.8	14.2	15.8	20.0	26.0	28.2	
Mains fuses 3 ph/PE	I	A	10.0	16.0	25.0		35.0		
General									
Short circuit / ground fault protection	-	-	Yes, unlimited						
Mounting position	-	-	Vertical						
Protection class	-	-	IP 20 (EN60529) ⁽⁰⁾						
Dimensions Std. A	HxWxD	mm	250 x 60 x 175	250 x 100 x 200			250 x 125 x 200		
Weight (approx.)	m	kg	1.6	3.0			3.7		
Brake unit	-	-	Internal brake transistor						
Environment									
Cooling temperature	T_n	°C	From 0 to 40 (3K3 DIN IEC 721-3-3)						
Relative air humidity	-	%	From 15 to 85, non-condensing						
Options & accessories									
Input line choke	-	-	External (depending on mains supply)						
EMI filter	-	-	Internal Class A (EN 61800-3); external Class B				External Class B		
Digital control unit	-	-	Yes						

Note: (0) = for protection classes higher than IP20 consult your local Bonfiglioli Drives Service Center

ACU401 - Technical data (from 18.5 to 30 kW)

ACU401-	27	29	31
Size 5 (-, A)			
Output, motor side			
Rated motor current output	I_n	A	40.0 45.0 60.0
Rated motor voltage output	U_n	V	3 x (from 0 to mains voltage)
Overload current	I_{pk}	A	60.0 67.5 90.0
Recommended rated motor power	P_n	kW	18.5 22.0 30.0
Switching frequency	f_c	kHz	From 2 to 16
Rated motor frequency	f_n	Hz	From 0 to 1000
Input, mains side			
Rated mains voltage	U	V	320 ... 528
Rated mains frequency	f	Hz	45 ... 66
Rated current 3 ph/PE	I	A	35.6 52.0 58.0
Mains fuses 3 ph/PE	I	A	50.0 63.0
General			
Short circuit / ground fault protection	-	-	Yes, unlimited
Mounting position	-	-	Vertical
Protection class	-	-	IP 20 (EN60529) ⁽⁰⁾
Dimensions Std. A	HxWxD	mm	250 x 200 x 260
Weight (approx.)	m	kg	8.0
Brake unit	-	-	Internal brake transistor
Environment			
Cooling temperature	T_n	°C	From 0 to 40 (3K3 DIN IEC 721-3-3)
Relative air humidity	-	%	From 15 to 85, non-condensing
Options & accessories			
Input line choke	-	-	External (depending on mains supply)
EMI filter	-	-	External Class B
Digital control unit	-	-	Yes

Note: (0) = for protection classes higher than IP20 consult your local Bonfiglioli Drives Service Center

ACU401 - Technical data (from 37 to 65 kW)

ACU401-	33	35	37	39		
Size 6 (-, A)						
Output, motor side						
Rated motor current output	I_n	A	75.0	90.0	110.0	125.0
Rated motor voltage output	U_n	V	3 x (from 0 to mains voltage)			
Overload current	I_{pk}	A	112.5	135.0	165.0	187.5
Recommended rated motor power	P_n	kW	37.0	45.0	55.0	65.0
Switching frequency	f_c	kHz	From 2 to 8			
Rated motor frequency	f_n	Hz	From 0 to 1000			
Input, mains side						
Rated mains voltage	U	V	320 ... 528			
Rated mains frequency	f	Hz	45 ... 66			
Rated current 3 ph/PE	I	A	72	86	105	120
Mains fuses 3 ph/PE	I	A	80	100	125	125
General						
Short circuit / ground fault protection	-	-	Yes, unlimited			
Mounting position	-	-	Vertical			
Protection class	-	-	IP 20 (EN60529) ⁽⁰⁾			
Dimensions Std. A	HxWxD	mm	400 x 275 x 260			
Weight (approx.)	m	kg	20			
Brake unit	-	-	Internal brake transistor			
Environment						
Cooling temperature	T_n	°C	From 0 to 40 (3K3 DIN IEC 721-3-3)			
Relative air humidity	-	%	From 15 to 85, non-condensing			
Options & accessories						
Input line choke	-	-	External (depending on mains supply)			
EMI filter	-	-	External Class B			
Digital control unit	-	-	Yes			

Note: (0) = for protection classes higher than IP20 consult your local Bonfiglioli Drives Service Center

ACU401 - Technical data (from 75 to 132 kW)

ACU401-			43	45	47	49
Size 7 (-, A)						
Output, motor side						
Rated motor current output	I_n	A	150.0	180.0	210.0	250.0
Rated motor voltage output	U_n	V	3 x (from 0 to mains voltage)			
Overload current	I_{pk}	A	225.0	270.0	315.0	332.0
Recommended rated motor power	P_n	kW	75.0	90.0	110.0	132.0
Switching frequency	f_c	kHz	From 2 to 8			
Rated motor frequency	f_n	Hz	From 0 to 1000			
Input, mains side						
Rated mains voltage	U	V	320 ... 528			
Rated mains frequency	f	Hz	45 ... 66			
Rated current 3 ph/PE	I	A	143	172	208	249
Mains fuses 3 ph/PE	I	A	160	200	250	315
General						
Short circuit / ground fault protection	-	-	Yes, unlimited			
Mounting position	-	-	Vertical			
Protection class	-	-	IP 20 (EN60529) ⁽⁰⁾			
Dimensions Std. A	HxWxD	mm	510 x 412 x 351			
Weight (approx.)	m	kg	45		48	
Brake unit	-	-	Internal brake transistor			
Environment						
Cooling temperature	T_n	°C	From 0 to 40 (3K3 DIN IEC 721-3-3)			
Relative air humidity	-	%	From 15 to 85, non-condensing			
Options & accessories						
Input line choke	-	-	External (depending on mains supply)			
EMI filter	-	-	External Class B			
Digital control unit	-	-	Yes			

Note: (0) = for protection classes higher than IP20 consult your local Bonfiglioli Drives Service Center

Inverter selection and dimensioning

Choosing the most suitable inverter rating according to application needs is essential to get the best out of Active Cube series. Too small a rating selection may cause unsatisfactory performance and disappointing low productivity of the machine. Selection of too high a rating may increase cost and generate problems in setting motor control.

This section gives some basic hints to determine the optimum rating and model of drive to properly match your application requirements.

Since Active Cube is able to operate both as a

high technology "System drive" matched with asynchronous induction motors, and as a "Servo drive", together with synchronous servomotors, two different criteria are proposed:

Asynchronous induction motors (continuous load)

Active Cube is driving traditional squirrel cage induction motors (e.g. Bonfiglioli M and BN series). Applications are usually featured by continuous torque supply for long time with occasional smooth overload needs. An example of typical torque profile is shown below.

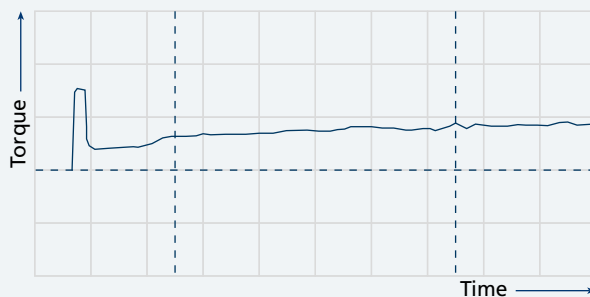

In case of continuous torque, dimensioning and selection of Active Cube can be done through these steps:

- a. Check mains supply phases (1 or 3 phase) and mains supply voltage ($\approx 230V$ or $\approx 400V$)
If mains voltage is 1ph-230V or 3ph-230V
-> ACU201 series
If mains voltage is 3ph-400V -> ACU401 series
- b. Check if application conditions (ambient temperature, altitude, mains values,...) are within rated conditions
-> in case of unusual operating conditions, please refer to DSC for proper product dimensioning.
- c. Check rated motor current for continuous load I_N motor (see motor plate - rated current), overload motor current required I_{MAX} motor and overload time.
Select drive rating (see data sheets in "Technical data" section of this catalogue) applying, together, following conditions:
 - I_N drive $\geq I_N$ motor (rated drive current higher than rated motor current)
 - $I_{pk} \geq I_{MAX}$ motor (overload drive current higher than overload motor current)
 - Overload time ≤ 60 secs (overload time shorter than 60secs every 10mins)
- d. EMC protection class required
 1. A1 -> nothing required up to 9,2kW
 2. A2 -> external EMC filter required (see EMC filters in "Accessories" section of this catalogue)
 3. B -> external EMC filter required (see EMC filters in "Accessories" section of this catalogue)
- e. Input, output, feedback acquisition, communication among drives needed?
-> Select expansion modules (see option modules in "expansion modules" section of this catalogue)
- f. Communication with other electronic devices (PLC, HMI, DCS,...) needed?
-> Select communication modules (see option modules in "communication modules" section of this catalogue)
- g. Harmonic problems expected?
-> Select line choke (see line choke in "Accessories" section of this catalogue)
- h. Is motor equipped with encoder or resolver feedback device? Do we need encoder emulation?
-> Select feedback module (see option modules in "expansion modules" section of this catalogue)
- i. Is braking resistor required?
-> Select braking resistor (see braking resistor in "Accessories" section of this catalogue)

Inverter selection and dimensioning

Synchronous permanent magnets servomotors (intermittent load)

Active cube is driving high performance synchronous PM servomotors (e.g. Bonfiglioli BT

and BCR series). Applications are usually featured by intermittent very high torque demand for short time. An example of typical torque profile is shown below.

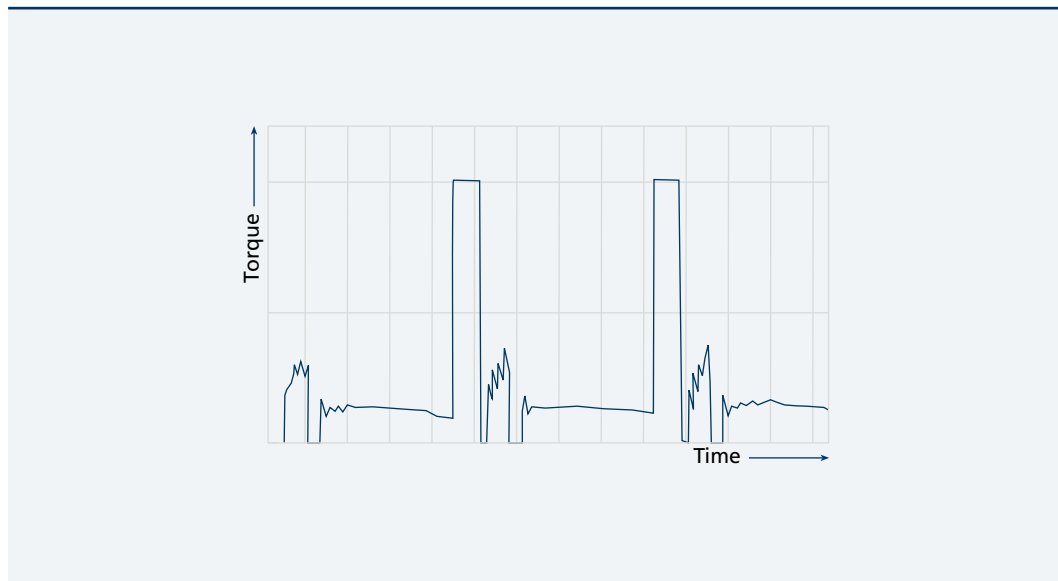

In case of intermittent torque with high peaks, the dimensioning and selection of Active Cube, can be done through these steps:

- a. Check mains supply phases (1 or 3 phase) and mains supply voltage ($\approx 230V$ or $\approx 400V$)
If mains voltage is 1ph-230V or 3ph-230V -> ACU201 series
If mains voltage is 3ph-400V -> ACU401 series
- b. Check if application conditions (ambient temperature, altitude, mains values,...) are within rated conditions
-> in case of unusual operating conditions, please refer to DSC for proper product dimensioning.
- c. Calculate RMS torque M_{RMS} and relevant RMS motor current I_{RMS} required, depending on load profile graphic of the application
- d. Calculate motor peak torque M_{MAX} out of load profile graphic of the application and resulting peak current required I_{MAX}
- e. Select the drive matching together following conditions:
 - I_n drive $\geq I_{RMS}$ motor (rated drive current higher than equivalent motor current)
 - I_{pk} drive $\geq I_{MAX}$ motor (peak drive current higher than PK motor current)
- f. Is Bonfiglioli BT or BCR servomotor used?
Yes: -> Select EMRES03 or EMABS01 feedback modules (see option modules in "expansion modules" section of this catalogue)
No: -> Select any feedback module suitable to the servomotor used (see option modules in "expansion modules" section of this catalogue)
- g. EMC protection class required
 1. A1 -> nothing required up to 9,2kW
 2. A2 -> external EMC filter required (see EMC filters in "Accessories" section of this catalogue)
 3. B -> external EMC filter required (see EMC filters in "Accessories" section of this catalogue)
- h. Input, output, feedback acquisition, communication among drives needed?
-> Select expansion modules (see options modules in "expansion modules" section of this catalogue)
- i. Communication with other electronic devices (PLC, HMI, DCS,...) needed?
-> Select communication modules (see options modules in "communication modules" section of this catalogue)
- j. Harmonic problems expected?
-> Select line choke (see line choke in "Accessories" section of this catalogue)
- k. Is braking resistor required?
-> Select braking resistor (see braking resistor in "Accessories" section of this catalogue)

Options modules

Active Cube is designed to give the highest flexibility in drive hardware to suit every control requirement. Machine designers can select from an extensive range of possible expansion hardware modules that can be fitted directly into the 3 available slots on the standard Active Cube unit. Mounting and connection is fast and easy thanks to onboard fastening devices.

Using option modules, Active Cube features and integration ability can be greatly expanded: the number of possible hardware configurations that can be achieved through combinations of different modules is surprisingly high.

Build the best hardware configuration of Active Cube for your application!

Hardware modularity

Interface module

Connection of optional control unit KP500, serial interface adapter KP232, or the control unit remotization cable for accessory KPCMK



Interface module

CM communication module

Connection panel for various communication protocols:

- CM-232, RS232 interface
- CM-485, RS485 interface
- CM-PDP V1, Profibus-DP interface
- CM-CAN, CANopen interface
- CM-DEV, Devicenet interface
- CM-EtherCAT®, EtherCAT® interface
- CM-ProfiNet, Profinet interface
- CM-VABus/TCP, Ethernet VA BUS TCP interface
- Other protocols on request



CM communication module

EM expansion module

Connection panel for adaptation of control inputs and outputs to the various applications on the basis of specific customer requirements:

- EM-IO, analog and digital inputs and outputs, available in 4 variants
- EM-ENC, speed sensor interface, frequency output and system bus, available in 5 variants
- EM-RES, resolver interface, frequency output and system bus, available in 3 variants
- EM-SYS, system bus for Systembus communication
(On request, system bus combined with CM-CAN communication module)
- EM-ABS, absolute encoder module
- Other customised modules available on request









EM expansion module

Options modules











Option modules can be ordered either separately or together with ACU base unit, as an "extended" power package.
The majority of Active Cube option modules can also be used in the Active series, thus allowing

drives from both series to be easily used in the same automation system.
Select from below the hardware module to customize Active Cube and build a unique drive which best fits to the needs of your application.

		AI	AO	DI	DO	Relay	RF	Speed encoder		System bus
								Type (s)	Zero pulse	
Basic equipment of Active Cube		1²⁾	-	6³⁾	1	1	-	HTL	yes	yes
	EM-IO-01	1	1	3	-	2	-	HTL	yes	yes
	EM-IO-02	1	1	3	-	1	-	HTL	yes	yes
	EM-IO-03	1	2	2	-	1	-	HTL	no	yes
	EM-IO-04	-	-	2	1 ¹⁾	-	-	-	-	yes
	EM-ENC-01	1	-	-	-	-	yes ⁵⁾	TTL & HTL	no	yes
	EM-ENC-02	1	1	-	1 ¹⁾	-	-	TTL & HTL	no	yes
	EM-ENC-03	-	-	-	-	-	-	TTL & HTL	no	yes
	EM-ENC-04	1	1	-	-	1	-	TTL & HTL	yes	no
	EM-ENC-05	1	1	-	-	-	-	TTL & HTL	yes	yes
	EM-RES-01	1	-	-	-	-	yes ⁵⁾	Resolver		yes
	EM-RES-02	1	-	-	-	-	yes ⁶⁾	Resolver		no
	EM-RES-03	1	-	3	2	-	-	Resolver ⁴⁾		yes
	EM-SYS	-	-	-	-	-	-	-	-	yes
	EM-ABS-01	1	-	3	2	-	yes ⁵⁾	Endat 2.1 hipurface SSI		yes

- 1) Can be used as digital input alternatively
2) MF1 can be used as digital input alternatively
3) One is used for control enable. DI can be used for encoder 1 if required.
4) EM-RES-03: Resolver and PTC are run through a DSub 9 connector.

- 5) Repetition frequency without Zero Pulse
6) Repetition frequency with Zero Pulse
RF: Repetition frequency, speed sensor simulation.
All inputs/outputs are realized with disconnectable terminals

Communication		
	CM-CAN	Connectors realized with DSub 9 plugs
	CM-PDPV1	
	CM-485	
	CM-232	
	CM-CAN-T	Bus connection via Spring-type terminal
	CM-PDPV1-T	
	CM-485-T	
	CM-DEV	
	CM-EtherCAT®	
	CM-ProfiNet	
	CM-VABus/TCP	

Control unit / KP500

The KP500 control unit is equipped with a Parameters Copy function that allows the user to upload parametric values from the inverter to a non-volatile memory installed in the KP500 device, allowing the same values to be subsequently downloaded to another inverter.

The control unit makes it possible to set up the inverter for specific applications and allows the display of the service values of physical and electrical parameters. The inverter can also be controlled from the control unit for start/stop and frequency reference increase/decrease commands. Since the control unit is not essential for inverter operation it can be connected when the user considers it useful or necessary.



*Control unit remote installation kit / KPCMK
The KPCMK kit is used to remotely control the inverter from the KP500 unit.*

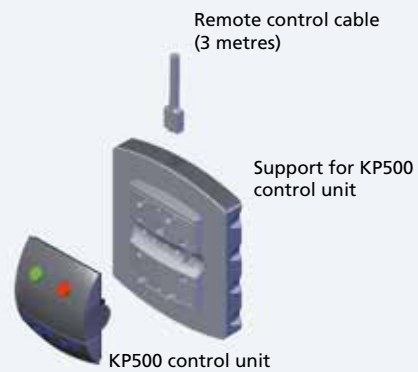

Handheld remote control unit

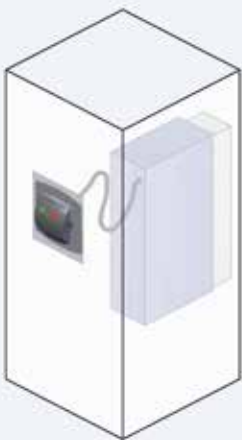

Remote installation on exterior of enclosure

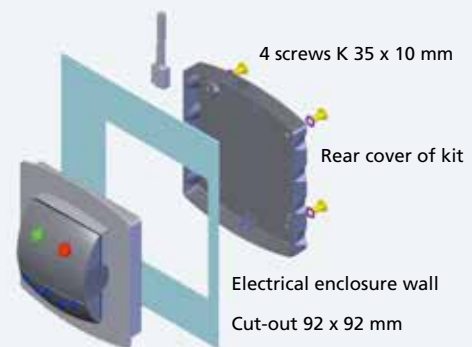

Fixing to enclosure



Interface / KP-232

Serial interface KP232 can be used as an alternative to control unit KP500. This connection enables parameterisation, monitoring, setting management, inverter control and even commissioning from a PC or laptop computer. The serial point-to-point connection between inverter and PC complies with specifications for transmission between data terminals (DTE) and data communication equipment (DCE), requiring, in this mode, a serial pin-to-pin cable with DB9 male connector on the inverter side.

The KP232 interface is compatible with lines no longer than 15 metres. The serial transmission protocol ensures high data security and does not require handshake signals between computer and inverter.

The VPlus software application can be supplied as an accessory. This program, which runs in Windows, is dedicated to the complete management of the ACTIVE CUBE inverter from a PC, including the functions of commissioning and parameterisation, which calls for the presence of hardware interface KP232, CM232 or CM485. The VPlus package also includes a digital Oscilloscope Function. The oscilloscope has four traces configurable for inverter monitoring also with graphic capabilities.

Technical data

Baud rate (kBaud)	Up to 115.2 kb
-------------------	----------------

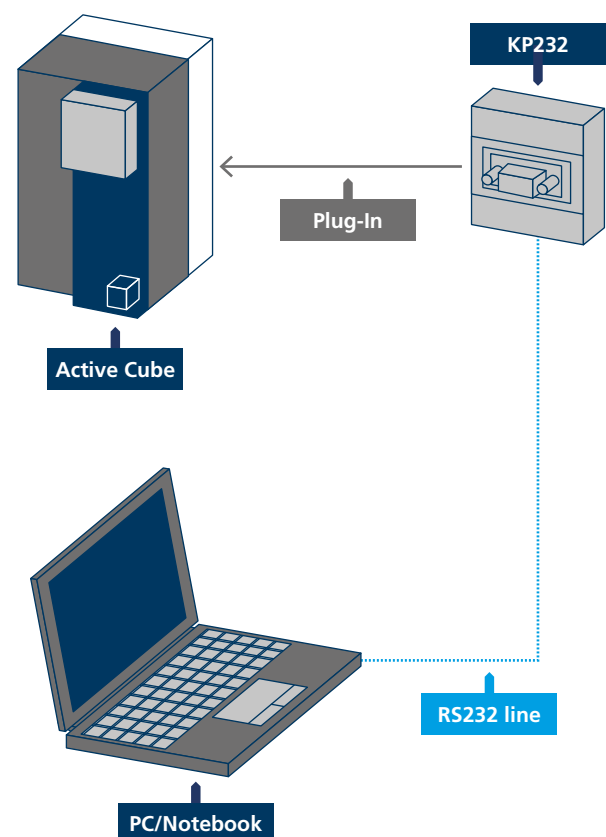

RS232 / CM-232 serial communication

The optional CM-232 communication card enables RS232 serial connection of the Active Cube inverter to an external control device or PC to ANSI standard EIA/TIA-232E and CCITT V.28. The standard defines the electrical and mechanical characteristics of serial connections between data terminating equipment (DTE) and data communication equipment (DCE).

The serial interface, in the form of a DB9 plug, features DCE type pinouts.

The serial transmission protocol ensures high data security and allows connection, also without handshake signals, thereby reducing the required number of connection lines to just three.

Maximum allowed distance between the various bus nodes (inverters) and the master (PC, PLC) depends on the cable used and the selected transmission rate.

This option can be used as well for inverter programming and monitoring with VPlus software.



Cable length	Max Baud rate
up to 30m	19.2
up to 10m	115.2

Cable length limits the transmission bandwidth. Above table shows the match between admissible cable lengths and corresponding max kBaud rates. Values are indicative and may significantly change in relation to the transmission cable characteristics.

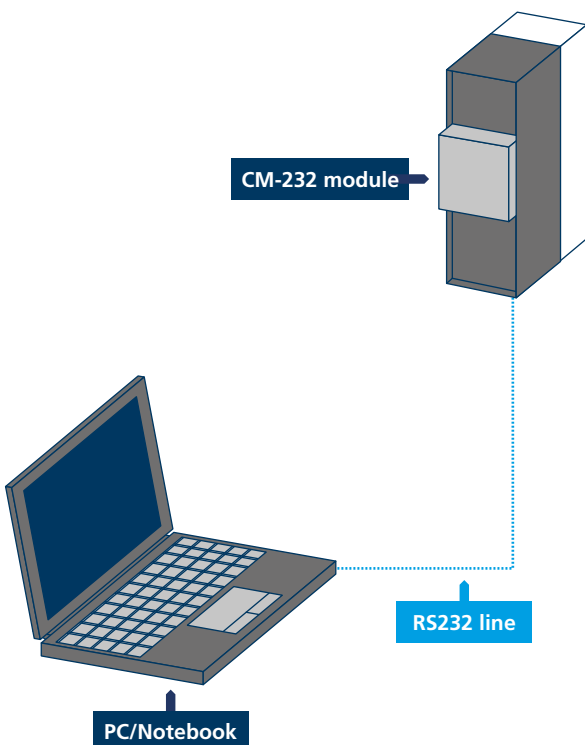

Location of CM-232 module on the frequency inverter

RS485 / CM-485 serial communication



The CM-485 communication module is designed for high speed data transmission over long distances in industrial applications. RS485 bus supports data exchange among 30 nodes in a bidirectional 2-wires system.

The interface is based on a DB9 connector, following the standards for physical transmission of data ITU V.11 and ANSI EIA/TIA-422B

CM-485 communication card includes the end-of-line terminating resistor that can be activated or disconnected by means of an on-board dip switch.

The RS485 network address of the inverter is set by software parameters either via KP500 control unit or by means of PC in serial communication with KP-232. The RS485 complies with ISO standard 1745 for code-bound data transmission. The standard data exchange rate and monitoring functions can be set using VPlus software.

Cable lenght	Max Baud rate
up to 12000m	4.8
up to 2000m	19.2

Cable length limits the transmission bandwidth. Above table shows the match between admissible cable lengths and corresponding max kBaud rates. Values are indicative and may significantly change in relation to the transmission cable characteristics.



Location of CM-485 module on the frequency inverter

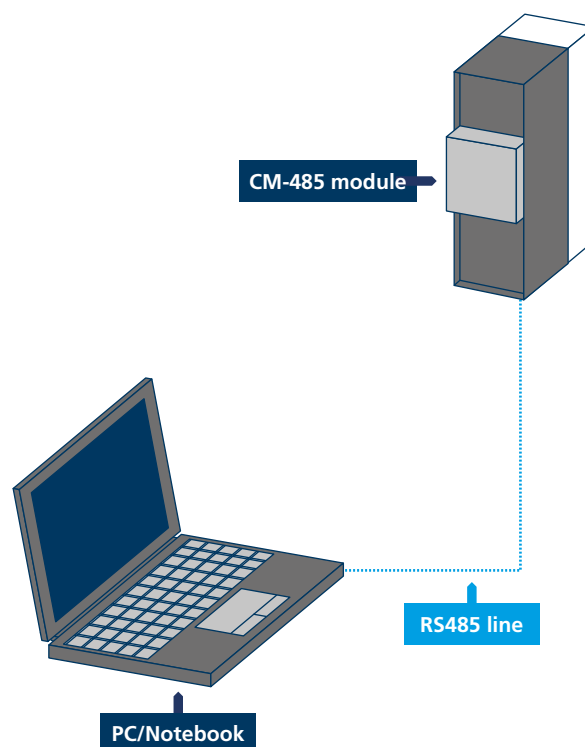

RS485 / CM-485 serial and Modbus communication

Modbus communication

The communication module CM-485 allows to use the Modbus Communication profile to be used. The communication profile can be easily changed to Modbus with a parameter. Therefore a very inexpensive solution is available to integrate the Active Cube inverters in a Modbus Communication environment with the standard Active Cube devices and a standard module.

There are two profiles available. The Modbus RTU profile is well established and known to the experienced Modbus user, which offers quick communication between different devices. Additionally, Modbus ASCII is supported as well, which allows easy set up and diagnosis of the communication between different devices.

The address range allows values in the range between 1 to 247.



Cable length	Max Baud rate
up to 12000m	4.8
up to 2000m	19.2

Cable length limits the transmission bandwidth. Above table shows the match between admissible cable lengths and corresponding max kBaud rates. Values are indicative and may significantly change in relation to the transmission cable characteristics.

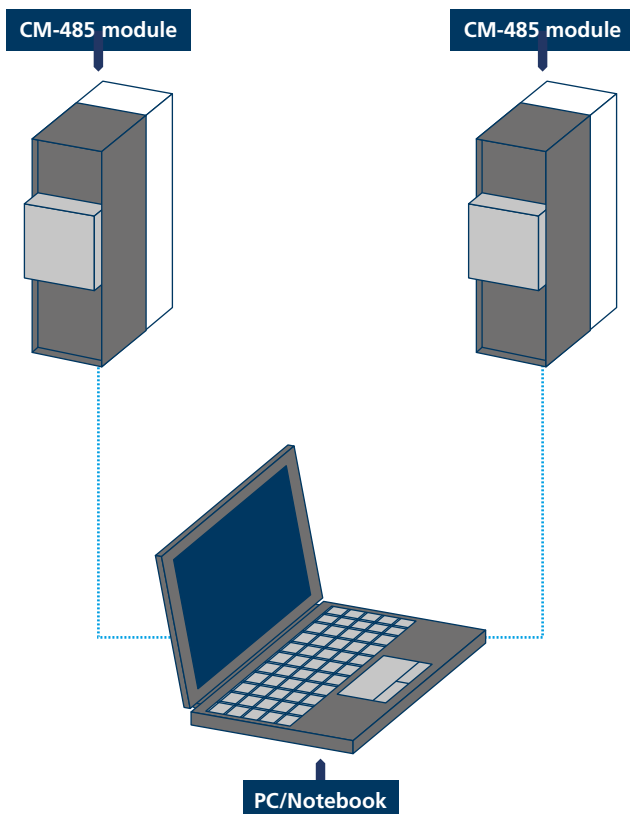

Location of module CM-485 on the frequency inverter

DP / CM-PDP V1 Profibus Communication



Internal dipswitch to enable the 220 Ω terminating burden resistor incorporated in the module

Profibus DP interface fulfils fieldbus standard DIN 19245. This Profibus version, which is optimized in order to provide excellent performance in terms of speed and low connection costs, has been adapted for communication between automation systems and decentralized peripheral devices.

Following "variable speed drive" profiles defined by Profidrive for electrical drive technology are supported by CMP-DP: PPO1, PPO2, PPO3, PPO4.

CM-PDP interface supports different transmission rates in compliance with EN 50170 standard. The transmission rate automatically adjusts to the settings of the fieldbus master.

CM-PDP module is equipped with a DIP switch to activate end-of-line terminating resistor, included into CM-PDP.

Cable lenght	Max Baud rate
up to 1200m	93.75
up to 1000m	187.5
up to 400m	500
up to 200m	1500
up to 100m	12000

Cable length limits the transmission bandwidth. Above table shows the match between admissible cable lengths and corresponding max kBaud rates. Values are indicative and may significantly change in relation to the transmission cable characteristics.



Location of module CM-PDP on the frequency inverter

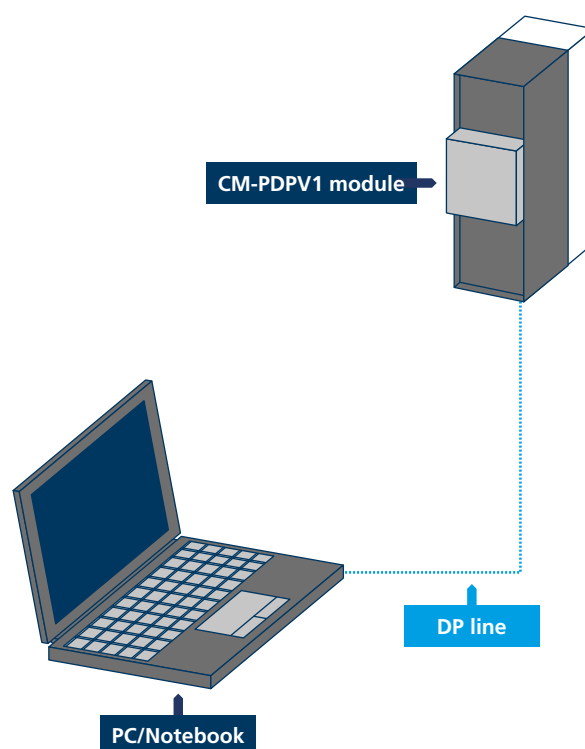

CANopen / CM-CAN communication

The CM-CAN communication option with controller area network interface, complies with ISO/DIS 11898 transmission standard. The pinout of connector DB9 is based on the "CAN in Automation e.V." specification, which allows the connection of up to 127 nodes in the network. The network node addresses are assigned via software. The endburden resistor is activated by means of a DIP switch on the module. The end of line terminating current transmission protocol complies with CANopen specifications DS-301 V4.02. The maximum allowed distance between the bus nodes depends on the cable used and the selected transmission rate. See table.



Internal dipswitch to enable the terminating resistor incorporated in the module

Cable length	Max Baud rate
up to 5000m	10
up to 2500m	20
up to 1000m	50
up to 800m	100
up to 500m	125
up to 250m	250
up to 100m	500
up to 25m	1000

Cable length limits the transmission bandwidth. Above table shows the match between admissible cable lengths and corresponding max kBaud rates. Values are indicative and may significantly change in relation to the transmission cable characteristics.

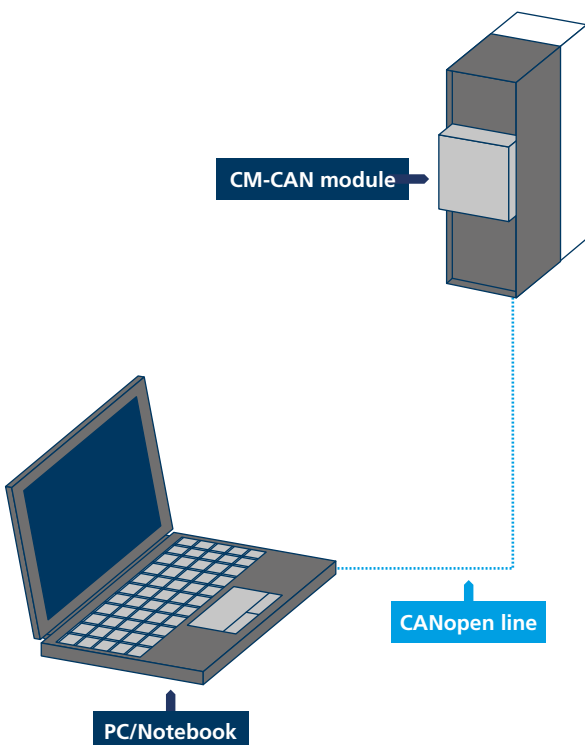

Location of CM-CAN module on the frequency inverter

Devicenet / CM-DEV communication



DeviceNet interface CM-DEV fulfils ODVA/CIP specification. It supports 2 types of connection: explicit message and I/O message.

For I/O data exchange the following CIP defined output assemblies and input assemblies for AC drives are available: output assemblies 20, 21, 22, 24, input assemblies 70, 71, 72, 74.

In addition, the vendor specific output assembly 100 and input assembly 101 are available.

CM-DEV is equipped with a 5-pole open style plug connector, designed in accordance to ODVA standard.

CM-DEV benefits from the same design of other communication modules which allows an easy plug and play mounting and connection to the drive.

Several very high transmission rates are supported, that are set according to the transmission cable length.

Cable lenght	Max Baud rate
up to 500m	125000
up to 250m	250000
up to 100m	500000

Cable length limits the transmission bandwidth. Above table shows the match between admissible cable lengths and corresponding max kBaud rates. Values are indicative and may significantly change in relation to the transmission cable characteristics.



Location of module CM-DEV on the frequency inverter

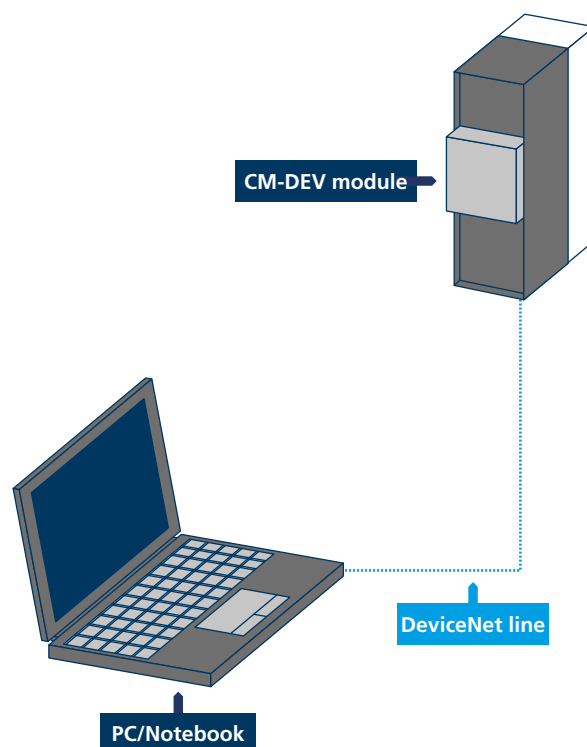

EtherCAT® / CM-EtherCAT® communication

The EtherCAT® communication module CM-EtherCAT® is compliant with the standard of EtherCAT® Technology Group (ETG). SDO and PDO objects are managed. Standard DS402 "drive motion control" modes are supported: Profile position mode, Velocity mode, Profile velocity mode, Homing, Interpolated mode. Access and control of all parameters of frequency inverter is possible from external control unit (e.g. PLC) which is compatible with EtherCAT® standard. Suitable to networks applying "synchronized communication with distributed clocks (DCs)".

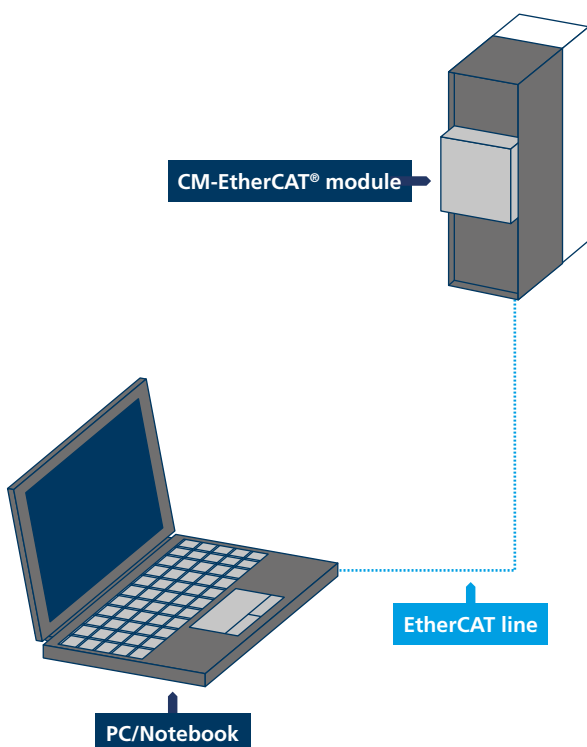

Location of CM-EtherCAT® module on the frequency inverter

Profinet / CM-ProfiNet communication



Profinet interface CM-ProfiNet allows Active Cube to communicate effectively with Profinet networks.

2 configurations are supported: non-motion configuration (based on Active Cube speed control configurations) and motion control configurations (via Motion Control Interface MCI).

Several modes of operation are implemented in motion control configuration : Profile position mode, Velocity mode, Profile velocity mode, Homing and the proprietary Table Travel record mode.

PKW and PDZ objects are managed.

Access and control of all parameters of frequency inverter is possible from external control unit (e.g. PLC) which is compatible with Profinet standard.

Your Bonfiglioli references are at disposal to help you in the selection of the Profinet network switch which is most suitable to your application.



Location of module CM-ProfiNet on the frequency inverter

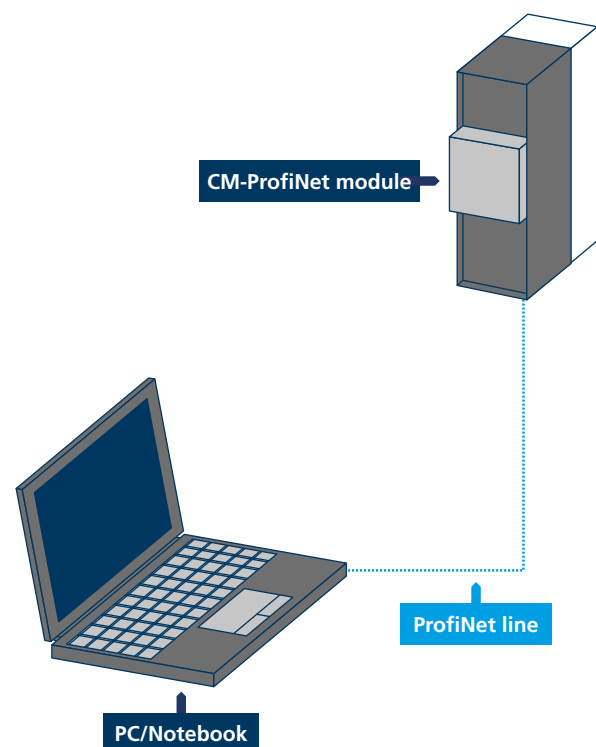

Ethernet VA BUS TCP / CM-VABus/TCP communication

The CM-VABus/TCP modules supports an Ethernet TCP/IP connection.
2 versions are available: CM-VABus/TCP version has one active RJ connector, while CCM-VABus/TCP 2P version has two active RJ connectors and implements switch function for daisy chaining of multiple inverters.
Ethernet features: 10/100MB (10 Base-T/100 Base-T), auto negotiation, MDI/MDIX
Contemporary communication of VPlus and PLC to the same inverter possible
TCP/IP configuration utility available.

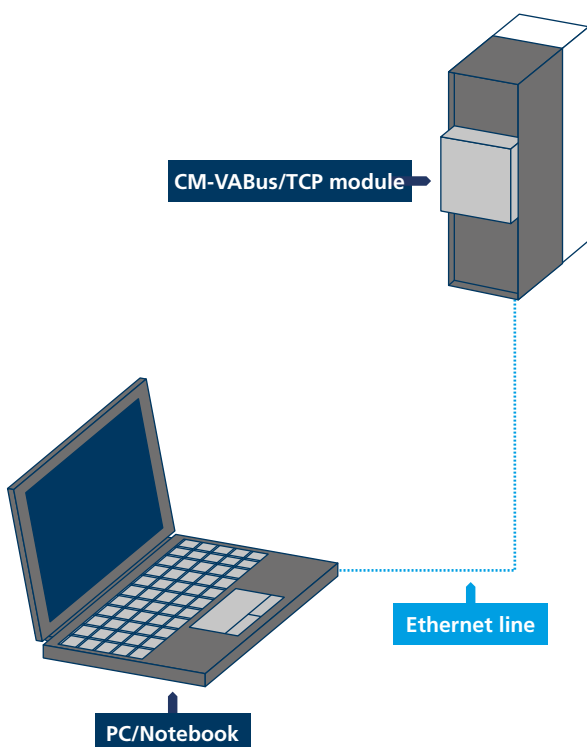

Location of CM-VABus/TCP module on the frequency inverter



System bus / EM-SYS module

The "System Bus" of Active Cube inverters is a proprietary communication bus, based on CANopen protocol that allows fast exchange of data between the inverters and access, by a system bus master, to the parameters of all devices connected on the network.

The system bus nodes (max. 64) are connected by a two-wire line.

The Bus termination (at either first or last node) can be activated via DIP switches of the EM-SYS module.

The system bus is equipped with three PDO (Process Data Object) channels that allow rapid exchanges of process data for each inverter. There are also two SDO (Service Data Object) channels for parameterisation purposes.

Thanks to the three PDO channels, with one transmission and one reception channel, all inverter data can be transmitted. Among other advantages, this makes it possible to create master/slave and daisy chain configurations easily, while ensuring very high precision and speed.

Each transmission and reception channel includes 8 bytes that can be freely occupied by objects, thereby offering the maximum flexibility for a very broad range of applications. The selection of transmission objects and reception objects is made easy by the VPlus program, and no additional configuration tools are needed.

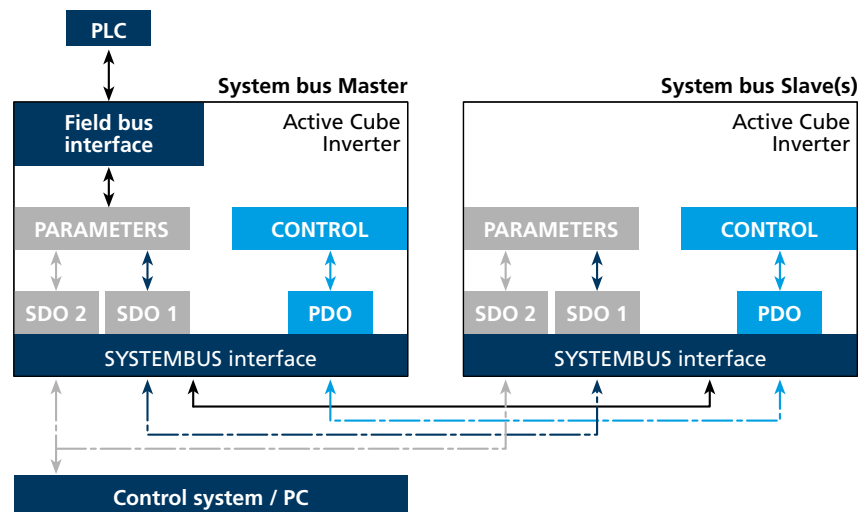

Location of EM-SYS module on the frequency inverter

Input-output module / EM-IO-01



The EM-IO-01 expansion module extends the number of the standard inputs and outputs provided on the ACT inverter for connection of various applications. Analog inputs and outputs can be available also with bipolar signals and must therefore be configured with inverter parameters. The supplementary digital inputs provided on the expansion module are electrically equivalent to the standard inputs. The relay changer contact represents an alternative for the activation of high power to the relay output available as a standard feature. SYSTEMBUS is available on two control terminals and supports easy control of decentralised drive systems. The module is equipped with a removable terminal board divided into two parts (X410A and X410B) that are physically separated.

Terminal board X410A

Terminal	Function
1	+20V / 180mA
2	GND 20V
3	EM-S1IND
4	EM-S2IND
5	EM-S3IND
6	EM-S1OUTD
7	EM-S1OUTD

Terminal	Function
X410A.1	20 VDC power supply output (180 mA)
X410A.2	20 V power supply GND
X410A.3	EM-S1IND multifunction digital input $V_{max} = 30\text{ V}$ (24 V/10 mA), PLC compatible
X410A.4	EM-S2IND multifunction digital input $V_{max} = 30\text{ V}$ (24 V/10 mA), PLC compatible
X410A.5	EM-S3IND multifunction digital input $V_{max} = 30\text{ V}$ (24 V/10 mA), PLC compatible
X410A.6	EM-S1OUTD multifunction relay output, $U_{max} = 24\text{ V}$, 1 A (ohmic)
X410A.7	

Terminal board X410B

Terminal	Function
1	EM-S2OUTD
2	EM-S2OUTD
3	EM-S1INA
4	EM-S1OUTA
5	CAN-Low
6	CAN-High
7	GND 10V

Terminal	Function
X410B.1	EM-S2OUTD multifunction relay output, $U_{max} = 24\text{ V}$, 1 A (ohmic)
X410B.2	
X410B.3	EM-S1INA +/- 10 V or +/- 20 mA analog input
X410B.4	EM-S1OUTA +/- 10 V multifunction analog output
X410B.5	CAN-Low Systembus
X410B.6	CAN-High Systembus
X410B.7	GND for +/- 10 V signals



Location of EM-IO-01 module on the frequency inverter



Input-output module / EM-IO-02

Like EM-IO-01, the EM-IO-02 expansion module extends the standard inputs and outputs featured on ACT frequency inverters. The EM-IO-02 module has a slightly modified layout compared to the -01 version, featuring an input for a PTC thermal probe in place of one of the module relay outputs. The functions of all the other terminals are same as in EM-IO-01.

Terminal board X410A

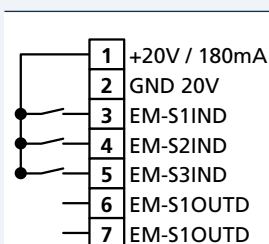

Terminal Function

Terminal	Function
X410A.1	20 V power supply output (180 mA)
X410A.2	20 V power supply GND
X410A.3	EM-S1IND multifunction digital input $V_{max} = 30\text{ V}$ (24 V/10 mA), PLC compatible
X410A.4	EM-S2IND multifunction digital input $V_{max} = 30\text{ V}$ (24 V/10 mA), PLC compatible
X410A.5	EM-S3IND multifunction digital input $V_{max} = 30\text{ V}$ (24 V/10 mA), PLC compatible
X410A.6	EM-S1OUTD multifunction relay output, $U_{max} = 24\text{ V}$, 1 A (ohmic)
X410A.7	

Terminal board X410B

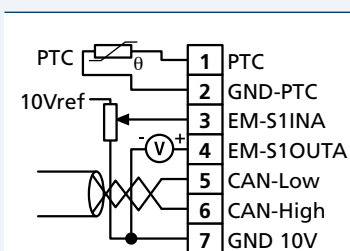

Terminal Function

Terminal	Function
X410B.1	Input for motor PTC
X410B.2	GND for motor PTC
X410B.3	EM-S1INA +/- 10 V or +/- 20 mA analog input
X410B.4	EM-S1OUTA +/- 10 V multifunction analog output
X410B.5	CAN-Low Systembus
X410B.6	CAN-High Systembus
X410B.7	GND for +/- 10 V signals



Location of EM-IO-02 module on the frequency inverter

Input-output module / EM-IO-03

The EM-IO-03 expansion module is another variant for the extension of I/O facilities of ACTIVE frequency inverters.



Terminal board X410A

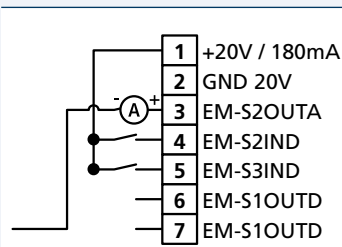

Terminal Function

Terminal	Function
X410A.1	20 V DC power supply output (180 mA)
X410A.2	20 V power supply GND
X410A.3	EM-S2OUTA multifunction analog output 0-20 V / 4-20 mA
X410A.4	EM-S2IND multifunction digital input $V_{max} = 30 \text{ V}$ (24 V/10 mA), PLC compatible
X410A.5	EM-S3IND multifunction digital input $V_{max} = 30 \text{ V}$ (24 V/10mA), PLC compatible
X410A.6	EM-S1OUTD multifunction relay output, $U_{max} = 24 \text{ V}$, 1 A (ohmic)
X410A.7	

Terminal board X410B

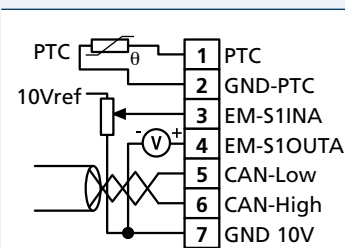

Terminal Function

Terminal	Function
X410B.1	Input for motor PTC
X410B.2	GND for motor PTC
X410B.3	EM-S1INA +/- 10 V and +/- 20 mA analog input
X410B.4	EM-S1OUTA +/- 10 V multifunction analog output
X410B.5	CAN-Low Systembus
X410B.6	CAN-High Systembus
X410B.7	GND



Location of EM-IO-03 module on the frequency inverter



Input-output module / EM-IO-04

The EM-IO-04 expansion module is another variant for the extension of I/O facilities of ACTIVE frequency inverters.

Terminal board X410A

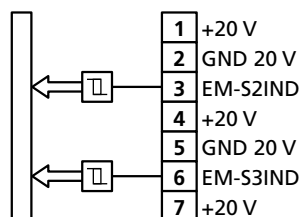

Terminal Function

Terminal	Function
X410A.1	Voltage output 20 V
X410A.2	Earth / GND 20 V
X410A.3	Digital input EM-S2IND
X410A.4	Voltage output 20 V
X410A.5	Earth / GND 20 V
X410A.6	Digital input EM-S3IND
X410A.7	Voltage output 20 V

Terminal board X410B

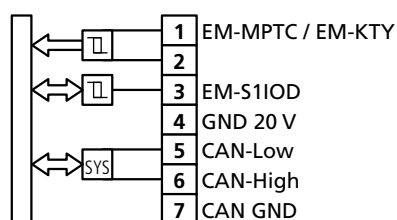

Terminal Function

Terminal	Function
X410B.1	Motor PTC thermistor connection EM-MPTC or connection motor temperature sensor EM-KTY
X410B.2	
X410B.3	Digital Port EM-S1IOD / Digital input or digital output
X410B.4	Earth / GND 20 V
X410B.5	CAN-Low Systembus
X410B.6	CAN-High Systembus
X410B.7	Earth / GND



Location of EM-IO-04 module on the frequency inverter

Speed sensor module / EM-ENC-01



The EM-ENC-01 expansion module extends the number of speed sensor inputs of terminal board of the frequency inverter, and also increases the number of configurable pulse outputs with encoder repetition output with encoder repetition output.

EM-ENC-01 is able to acquire both TTL and HTL incremental speed sensors according to standard EIA RS422 (line driver) with 5-volt logic. The EM-ENC-01 speed sensor module is equipped with connection terminals for signals A, \bar{A} , B and \bar{B} of the line driver speed sensor and terminals for repetition output of the same signals (speed sensor emulation). This makes it possible to create master-slave configurations between several separate units using output signals of one unit as input signals of the next. The DC +/- 10 V analog input can be used for the inverter frequency reference signal. The same terminal board also provides a DC + 5 V (200 mA) power supply for the line driver speed sensor.

As other EM expansion modules, the EM-ENC-01 features a Systembus interface.

Terminal board X410A

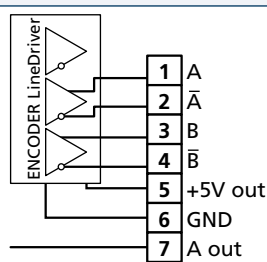

Terminal Function

Terminal	Function
X410A.1	Channel A speed sensor input
X410A.2	Channel \bar{A} speed sensor input
X410A.3	Channel B speed sensor input
X410A.4	Channel \bar{B} speed sensor input
X410A.5	+ 5 V (200 mA) power supply output
X410A.6	5 V power supply GND
X410A.7	Speed sensor channel A repetition output

Terminal board X410B

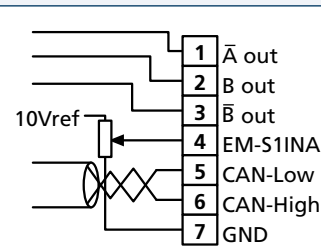

Terminal Function

Terminal	Function
X410B.1	Channel \bar{A} speed sensor repetition output
X410B.2	Channel B speed sensor repetition output
X410B.3	Channel \bar{B} speed sensor repetition output
X410B.4	EM-S11NA +/- 10 V analog input
X410B.5	CAN-Low Systembus
X410B.6	CAN-High Systembus
X410B.7	GND



Location of EM-ENC-01 module on the frequency inverter



Speed sensor module / EM-ENC-02

The EM-ENC-02 speed sensor module extends the standard terminal board of the inverter, providing an interface for line driver encoders with relative DC + 5 V power supply.

The same module is equipped also with a DC 0 ... 20 mA and +/- 20 mA analog input and a DC + 20 mA analog output, together with an input for a PTC thermal probe and a digital port configurable as an input or output. Also this module is equipped with a Systembus port.

Terminal board X410A

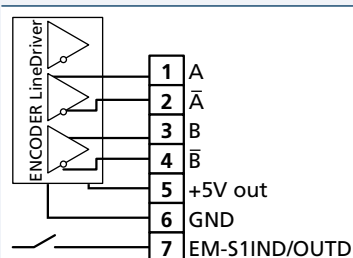

Terminal Function

Terminal	Function
X410A.1	Channel A speed sensor input
X410A.2	Channel \bar{A} speed sensor input
X410A.3	Channel B speed sensor input
X410A.4	Channel \bar{B} speed sensor input
X410A.5	+ 5 V (200 mA) power supply output
X410A.6	5V power supply GND
X410A.7	EM-S1IND/OUTD digital input/output

Terminal board X410B

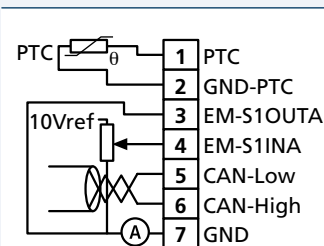

Terminal Function

Terminal	Function
X410B.1	Input for motor PTC
X410B.2	GND for motor PTC
X410B.3	EM-S10UTA 0 ... 20 mA analog output
X410B.4	EM-S11INA +/- 10 V and +/- 20 mA analog input
X410B.5	CAN-Low Systembus
X410B.6	CAN-High Systembus
X410B.7	GND



Location of EM-ENC-02 module on the frequency inverter

Speed sensor module / EM-ENC-03

The EM-ENC-03 extends the standard terminal board of the inverter, providing an interface for line driver speed sensors. Also this module is equipped with a Systembus port.



Terminal board X410A

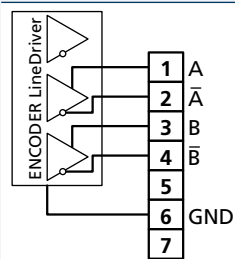

Terminal Function

Terminal	Function
X410A.1	Channel A speed sensor input
X410A.2	Channel \bar{A} speed sensor input
X410A.3	Channel B speed sensor input
X410A.4	Channel \bar{B} speed sensor input
X410A.5	-
X410A.6	GND
X410A.7	-

Terminal board X410B

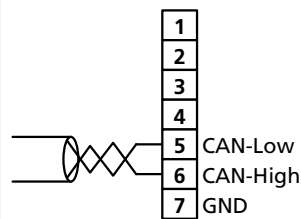

Terminal Function

Terminal	Function
X410B.1	-
X410B.2	-
X410B.3	-
X410B.4	-
X410B.5	CAN-Low Systembus
X410B.6	CAN-High Systembus
X410B.7	GND



Location of EM-ENC-03 module on the frequency inverter



Speed sensor module / EM-ENC-04

The EM-ENC-04 speed sensor module extends the standard terminal board of the inverter, providing an interface for line driver speed sensors with Z channel.

This module is able to manage TTL, HTL, or push-pull incremental speed sensors to standard EIA RS422 (line driver). The EM-ENC-04 speed encoder module is equipped with 6 control terminals for A, \bar{A} , B, \bar{B} direction signals and Z and \bar{Z} zero signals transmitted by the speed sensor.

The same module also features a ± 10 V and ± 20 mA analog input and a ± 10 V voltage output in addition to a digital relay output.

The module also features two output voltages (+ 5 V and + 24 V) for the speed sensor power supply.

Terminal board X410A

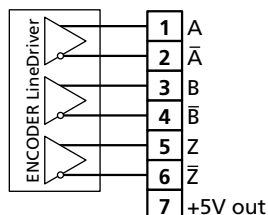

Terminal Function

X410A.1	Channel A speed sensor input
X410A.2	Channel \bar{A} speed sensor input
X410A.3	Channel B speed sensor input
X410A.4	Channel \bar{B} speed sensor input
X410A.5	Channel Z speed sensor input
X410A.6	Channel \bar{Z} speed sensor input
X410A.7	+ 5 V power supply output (200mA)

Terminal board X410B

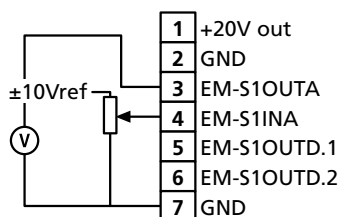

Terminal Function

X410B.1	+ 20 V power supply output (180 mA)
X410B.2	Power supply GND
X410B.3	± 10 V analog output
X410B.4	± 10 V analog input
X410B.5	EM-S1OUTD multifunction relay output, $U_{\max} = 24$ V, 1 A (ohmic)
X410B.6	
X410B.7	GND



Location of EM-ENC-04 module on the frequency inverter

Speed sensor module / EM-ENC-05



The EM-ENC-05 speed sensor module extends the standard terminal board of the inverter, providing an interface for line driver speed sensors with Z channel. This module is able to manage TTL, HTL, or push-pull incremental speed sensors to standard EIA RS422 (line driver). The EM-ENC05 speed encoder module is equipped with 6 control terminals for A, \bar{A} , B, \bar{B} direction signals and Z and \bar{Z} zero signals transmitted by the speed sensor. The same module also features a ± 10 V and ± 20 mA analog input and a ± 10 V voltage output in addition to a digital relay output. It is also equipped with a SYSTEMBUS communication bus.

Terminal board X410A

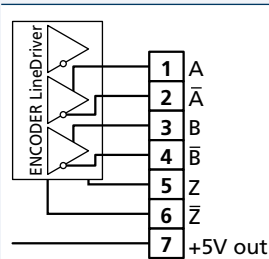

Terminal Function

Terminal	Function
X410A.1	Channel A speed sensor input
X410A.2	Channel \bar{A} speed sensor input
X410A.3	Channel B speed sensor input
X410A.4	Channel \bar{B} speed sensor input
X410A.5	Channel Z speed sensor input
X410A.6	Channel \bar{Z} speed sensor input
X410A.7	+ 5 V power supply output (200mA)

Terminal board X410B

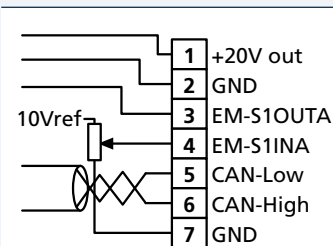

Terminal Function

Terminal	Function
X410B.1	+ 20 V power supply output (180 mA)
X410B.2	Power supply GND
X410B.3	EM-S1OUTATA 0 ... 20 mA analog output
X410B.4	EM-S1INA +/- 10 V and +/- 20 mA analog input
X410B.5	CAN-Low Systembus
X410B.6	CAN-High Systembus
X410B.7	GND



Location of EM-ENC-05 module on the frequency inverter



Resolver Module / EM-RES-01

The EM-RES-01 angular position transducer module extends the standard functions of the frequency inverter by providing a supplementary input for a resolver (electromechanical absolute speed sensor).

Resolver gives the instantaneous motor shaft position value even at standstill, and its angular position within a revolution.

EM-RES-01 provides 6 terminals for connection of the two $\sin\theta$ and $\cos\theta$ track signals generated by the transducer and also carry the resolver power supply voltage.

The module EM-RES-01 also supplies an output signal emulating a digital incremental speed sensor through the generation of squarewave signals A , \bar{A} , B , \bar{B} , which can be used for shaft synchronisation of any connected slave inverters.

The EM-S1INA multifunction analog input (± 10 V or ± 20 mA) and a Systembus communication port extend the standard functions of the ACT frequency inverter.

- Resolver evaluation
- Frequency repetition output without Zero-Pulse
- Analog input
- Systembus

Terminal board X410A

Terminal Function

	X410A.1	(+) ~6 VAC resolver power supply
	X410A.2	(-) ($I_{\max} = 60\text{mA}$)
	X410A.3	Resolver $\sin\theta$ signal input
	X410A.4	
	X410A.5	Resolver $\cos\theta$ signal input
	X410A.6	
	X410A.7	Channel A speed sensor emulation

Terminal board X410B

Terminal Function

	X410B.1	Channel \bar{A} speed sensor emulation
	X410B.2	Channel B speed sensor emulation
	X410B.3	Channel \bar{B} speed sensor emulation
	X410B.4	± 10 V or ± 20 mA analog input
	X410B.5	CAN-Low Systembus
	X410B.6	CAN-High Systembus
	X410B.7	GND



Location of EM-RES-01 module on the frequency inverter

Resolver Module / EM-RES-02



EM-RES-02 angular position transducer module extends the standard functions of the frequency inverter by providing a supplementary input for a resolver. This module shares all the features of EM-RES-01 except for the emulation of the encoder zero signal, which in this case replaces the Systembus port.

- Resolver evaluation
- Frequency repetition output with Zero-Pulse
- Analog input

Terminal board X410A

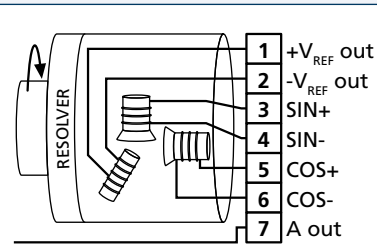

Terminal Function

Terminal	Function
X410A.1	(+) ~6 VAC resolver power supply
X410A.2	(-) ($I_{max} = 60mA$)
X410A.3	Resolver $\sin\theta$ signal input
X410A.4	
X410A.5	Resolver $\cos\theta$ signal input
X410A.6	
X410A.7	Channel A speed sensor emulation

Terminal board X410B

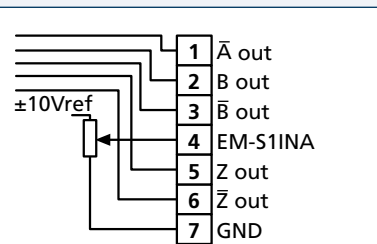

Terminal Function

Terminal	Function
X410B.1	Channel \bar{A} speed sensor emulation
X410B.2	Channel B speed sensor emulation
X410B.3	Channel \bar{B} speed sensor emulation
X410B.4	$\pm 10 V$ or $\pm 20 mA$ analog input
X410B.5	Channel Z speed sensor emulation
X410B.6	Channel \bar{Z} speed sensor emulation
X410B.7	GND



Location of EM-RES-02 module on the frequency inverter



Resolver Module / EM-RES-03

EM-RES-03 resolver module extends the standard functions of Active Cube servo inverter providing a supplementary input for resolver. It is designed specifically for BTD/BCR synchronous servomotors resolver feedback acquisition. EM-RES-03 is equipped with DB9 connector, that allows fast and easy connection to Bonfiglioli synchronous servomotors, when using BTD/BCR power and control cables.

As essential component of Bonfiglioli servo package, EM-RES-03 module can be used only in Active Cube.

Terminal board X410A

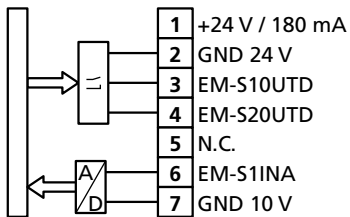

Terminal Function

Terminal	Function
X410A.1	DC-24 V output (max. 180 mA)
X410A.2	Ground 24 V
X410A.3	Digital output EM-S1OUTD
X410A.4	Digital output EM-S2OUTD
X410A.5	Not connected
X410A.6	Analog input EM-S1INA
X410A.7	Ground 10 V

Terminal board X410B

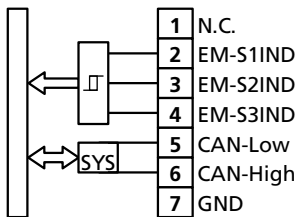

Terminal Function

Terminal	Function
X410B.1	Not connected
X410B.2	Digital input EM-S1IND
X410B.3	Digital input EM-S2IND
X410B.4	Digital input EM-S3IND
X410B.5	System bus, CAN-Low
X410B.6	System bus, CAN-High
X410B.7	Ground



Location of EM-RES-03 module on the frequency inverter

Resolver- and PTC input (SubD-9) Pin Designation Function

Pin	Designation	Function
Socket	Shielding	Connected with PE
1	PE	Protective earth conductor
2	PTC+	PTC thermistor connection
3	COS+	Cosinus track
4	SIN+	Sinus track
5	+UE	Excitation voltage
6	PTC-	PTC thermistor connection
7	COS-	Cosinus track
8	SIN-	Sinus track
9	-UE	Excitation voltage

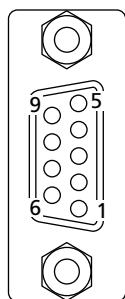

Encoder Module / EM-ABS-01



The expansion module EM-ABS-01 extends the ability of Active Cube inverter to acquire different absolute encoder feedbacks.

The following encoder standards can be connected to the drive via EM-ABS-01:

- SinCos (optionally with commutation tracks)
- Endat 2.1™ with SinCos track
- Hiperface™
- SSI (optionally with TTL[RS-422] or SinCos track)

Additional signal and functions are available when using EM-ABS-01:

- System bus CAN (Can interface ISO-DIS 11898, CAN High Speed, max 1 MBaud)
- Analog input DC -10...+10V or DC 0...+10V
- 3 digital inputs
- 2 digital outputs

With this universal encoder module all available encoder variants of Bonfiglioli servomotors offer can be effectively connected and acquired by Active Cube drive series.

Terminal board X410A

Terminal	Function
X410A.1	Voltage input DC 24 V
X410A.2	Ground DC 24 V
X410A.3	Digital output EM-S1OUTD
X410A.4	Digital output EM-S2OUTD
X410A.5	Voltage output DC 5 ... 12 V
X410A.6	Analog input EM-S1INA
X410A.7	Ground DC 10 V

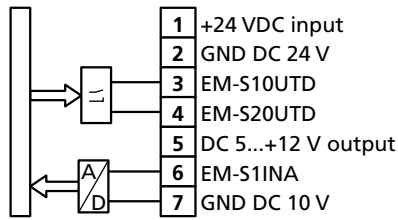

Terminal board X410B

Terminal	Function
X410B.1	Ground
X410B.2	Digital input EM-S1IND
X410B.3	Digital input EM-S2IND
X410B.4	Digital input EM-S3IND
X410B.5	System bus, CAN-Low
X410B.6	System bus, CAN-High
X410B.7	Ground

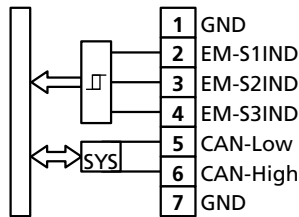

Contact	Function				
	Sin/Cos	Hiperface	EnDat 2.1	SSI	
Housing	PE	PE	PE	PE	
1	D-		Clock-	Clock-	
2	D+		Clock+	Clock+	
3	Cos-	Cos-	B- / Cos-	(optionally B- / Cos-)	
4	Cos+	Cos+	B+ / Cos+	(optionally B- / Cos-)	
5	TM _{PTC} -	TM _{PTC} -	TM _{PTC} -	TM _{PTC} -	
6	V _{ENC}	V _{ENC}	V _{ENC}	V _{ENC}	
7	R-				
8	C-	Data-	Data-	Data-	
9	Sin-	Sin-	A- / Sin-	(optionally A- / Sin-)	
10	TM _{PTC} +	TM _{PTC} +	TM _{PTC} +	TM _{PTC} +	
11	V _{ENC} Sensor		V _{ENC} Sensor	V _{ENC} Sensor	
12	R+				
13	C+	Data+	Data+	Data+	
14	Sin+	A+ / Sin+	A+ / Sin+	(optionally A+ / Sin+)	
15	GND	GND	GND	GND	

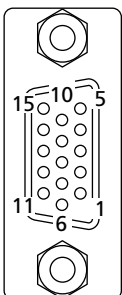

Location of EM-ABS-01 module on the frequency inverter

Engineering software



VPlus is a PC Windows-based engineering software tool that guides industrial automation designers through the steps towards the definition of the optimal configuration of Active Cube drives. Communication between VPlus and the drive is based on standard serial communication either through KP232, CM232, CM-485 or CM-VATCP interface. With VPlus a wide set of activities on Active Cube are possible:

Monitoring

Advanced display tools, help to have correct information about drive operation and process variables. "Actual values" windows collect all variables of interest in one screenshot and displays the real time value of them (variables can be selected by user). VPlus "dashboards" display real time values of selected variables with an effective visual tool.



Diagnosis

VPlus includes a reliable integrated oscilloscope monitor, able to provide real time traces of main device parameters and process selected variables. That distinctive feature is very useful both during normal operation and in case of exceptional events to collect comprehensive detailed information about drive behaviour, helping both analysis and troubleshooting. Commissioning your machine is easy with Oscilloscope monitor.

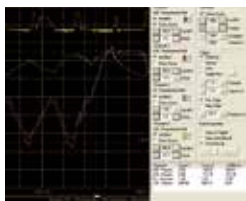

Inverter set up and parameter access

The drive setup up is really easy. Important functions like the motor set-up allow you to configure your system in short time. With the parameter tree design, all parameters are sorted logically by the functions and can be accessed intuitively.

Software customization

Drive software customization is possible having access to inner parameter levels and using PLC logic programming to create new drive control routines.

Technology functions management

High level technology functions of the drive, as well as specific application functions can be accessed and activated.

For example, VPlus software includes a section dedicated to setup and link of Motion Blocks for positioning applications, and a section for logic PLC functions management.

Also application customized functions are available, such as dynamic brake release control, spindle motor control, multipump management, and others.

Motor setup

A wide set of functionalities are available to get to faster and more effective motor "recognition". A dedicated window for induction motor rated values load is available, and new parameters can be freely selected and added to rearrange the default window. The accurate autotuning procedure of Active Cube, used to optimize motor control, can be started via software, through a simple flag change. The parameter values for Bonfiglioli synchronous servomotor control are available in the drive: rated speed, stall torque, load curves, resolver phase angle, etc. for all existing Bonfiglioli servomotors ratings are stored into the standard device. Selection and load of correct values for the servomotor is done directly by the drive after the motor designation is selected through an easy guided interface: the procedure takes only few seconds and no further autotuning is required to have the motor running correctly.

Commissioning

VPlus engineering software is very powerful tool in commissioning and machine start up phases, both in case Active Cube is used as a "system drive" and as "servo drive".

Usual adjustments to last minute requests and system troubleshooting needed, take benefit of the extreme flexibility and handy set of tools that engineers can find in VPlus to support "on site" activities.

Active Cube oscilloscope graphic presentation

The functionality and practicality of the virtual oscilloscope are identical to those of a powerful and modern conventional oscilloscope, with the added benefit that all the parameters controlled by the inverter microprocessor can be displayed, whether of a physical nature (current, voltage, frequency, etc.) or a virtual nature (internal control variables, timer signals, comparator signals, internal digital signals, etc.).

Salient features of the Oscilloscope Function:

- 4 channels
- Display of absolute values
- Amplitude and time measurement cursors
- Timebase from 20 ms/div to 50 s/div
- Various trigger types
- Graphic memory up to 1 Mbyte
- Trace recording memory up to 60 min.
- Sampling times from 2 ms to 32 ms (depending on the PC)
- Various trace storage formats



Function highlights

Active Cube control levels

Active Cube has by far the widest application potential of all Bonfiglioli drive offer, thanks to its extremely rich set of functionalities, combined with flexible hardware structure and significant power range extension.

3 “virtual” functional levels can be defined, related to different control “areas”:

Application control level,

includes special functions that can help fulfilling specific application control requirements, usually carried out by external logic control devices

Machine control level,

includes generic software blocks to build machine control, often by granting synergic action of several drives

Motor control level,

includes mathematical models of motor and all software routines that implement motor control

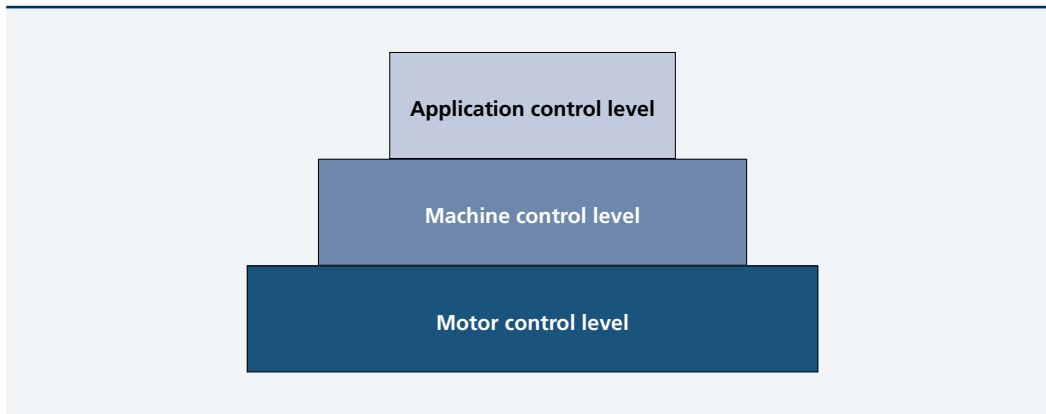

Motor control level

At Motor control level, Active Cube is designed to suite to almost all motor technologies used in industrial machines: synchronous servomotors, rotating or linear motors, as well as traditional asynchronous induction motors can be used with standard Active Cube devices..

Many available different control modes, provide the possibility to select the right mix of accuracy, ease, stability of performance to satisfy the requirements of any industrial applications, from fan and pump control, to sophisticated positioning or synchronization systems.

Motor control modes

Simple Sensorless Control of induction motors (mode 110)

Accuracy: •

Ease of use: ●●●●

Closed loop Field Oriented (Vector) control of induction motors (mode 210)

Accuracy: ●●●●

Ease of use: ●●

Sensorless Field Oriented (Vector) control of induction motors (mode 410)

Accuracy: ●●●

Ease of use: ●●●

Closed loop Field Oriented (Vector) control of synchronous servomotors (mode 515)

Accuracy: ●●●●

Ease of use: ●●●●

Function highlights

Machine control level

Within each Motor control mode, a range of “machine” control functions, belonging to Machine control level, is available. These functions aim to give to users and designers of Active Cube a set of ready-to-use routines and functions able to

fit, with few adjustments, the automation needs of many different machines and sectors: PID function, Master/Slave synchronization, electronic shaft/gear, torque/speed switching, and position control functions are only few examples.

Control mode		Control function					
		PID (x11)	Master slave & electronic gear (x15)	Torque/speed switching (x30)	Index control (x16)	Brake control & load detection (x60)	Position control (x40)
Simple sensorless for induction motors	110	X	X		X	X	
Closed loop field oriented of induction motors	210		X	X	X	X	X
Sensorless field oriented of induction motors	410	X	X	X		X	X
Closed loop field oriented of synchronous servomotors	510		X	X	X	X	X

Application control level

Third level “Application (specific) control level” includes particular features and control routines designed to match the requirements of unusual industrial applications.

These functions are giving to Active Cube exceptional ability to fulfil non-common needs of such applications: no necessity of customized versions of the drive, because software functions are stored in standard Active Cube devices and can

be activated directly by customer.

Examples are: spindle control up to 1000Hz (machining), extended brake control with load detection (lifting), synchronized “traverse” function (yarn winders), motion blocks management.

Please find more details about these functions in product documentation or to your local DSC.

Safe torque off (STO)

The safety function "Safe Torque Off" (STO) with the safety integrity level SIL 2 (see DIN EN 61508 and DIN IEC 61800-5-2) is implemented into standard Active Cube inverter range.

The drive feature helps overall automation system to achieve "Safe Stop" category 3, according to DIN EN 954-1.

Thanks to STO function, energy supply from frequency inverter to motor is safely disabled.

Deactivation of the inverter supply is carried out via two switch off paths in no-signal current mode, thus performing redundant switch off control. Continuous monitoring tests are done by the inverter to detect possible control failures. "Safe Torque Off" function greatly improves safety level of your automation system without the need of additional components.

Without STO

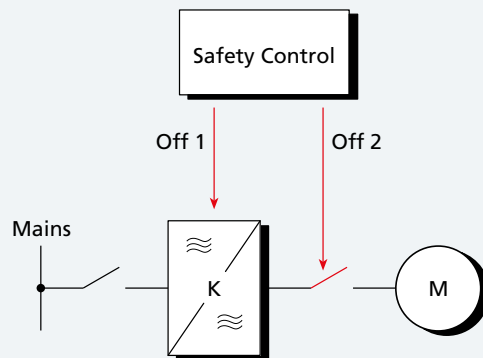

With STO

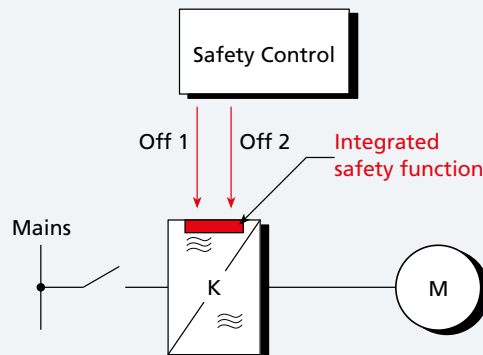

Logic functions

Standard Active Cube is equipped with integrated "PLC like" logic functions to exploit at best automation ability of the drive.

Onboard control logic functions are based on a runtime software able to execute a "block operation" every 1msec.

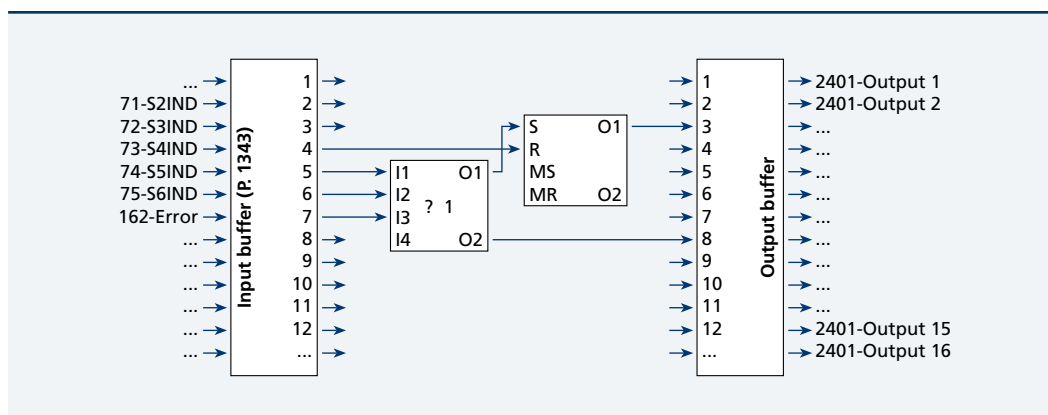

Sophisticated control routines design is within range with new logic functions. Software developers will be able to adjust drive controls fitting automation requirements, simply combining the 16 inputs with the 32 function blocks available and achieving results in the 16 output latches. Following features are implemented:

Input buffer for up to 16 signals

e.g. for

- Digitals inputs
- Errors
- Warnings
- RxPDO booleans of systembus

Output buffer for up to 16 signals

e.g. for

- Start clockwise / anticlockwise
- Data set change - over
- Digital outputs
- TxPDO booleans of systembus
- ...

32 functions configurable as

- Logic functions:
 - AND
 - OR
 - XOR
- Flip-flops:
 - RS-flip-flop
 - Toggle-flip-flop
 - D-flip-flop
- Timer-functions:
 - Delay for rising/falling edge
 - Mono-flop
 - Oscillator
- Additional functions:
 - Multiplexer for digital signals
 - Conditional jumps

Motion functions

Motion blocks

The “elemental software unit” of motion control in Active Cube is the “Motion Block”.

One “Motion Block” completely outlines one point-to-point positioning step, including:

- target position,
- speed,
- acceleration,
- deceleration,
- ramps,
- delays

Built-in motion control functions allow to combine up to 32 motion blocks in a conditional sequence, to program even most sophisticated point-to-point motion profiles

Motion Block 1		Motion Block 2		Motion Block 5	
Delay time	130 ms	Delay time	130 ms	Delay time	0 ms
Next index delay time	2	Next index delay time	4	Next index delay time	0
Event 1	S4IND	Event 1	S4IND	Event 1	S4IND
Next index event 1	3	Next index event 1	5	Next index event 1	0

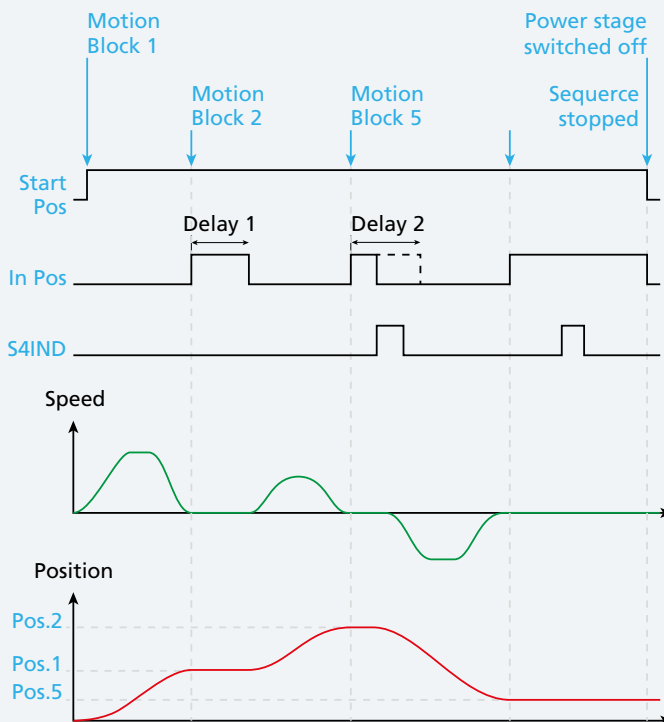

Motion functions

Homing

A comprehensive set of homing functions, according to CANOpen DSP 4.02 standard is available in Active Cube. 36 different homing modes can be used to answer to the motion

requirements of a wide range of machines. Homing search can be triggered by either digital input (e.g. hardware limit switches), or control word (if Fieldbus is used), or as an automatic procedure before first positioning sequence.

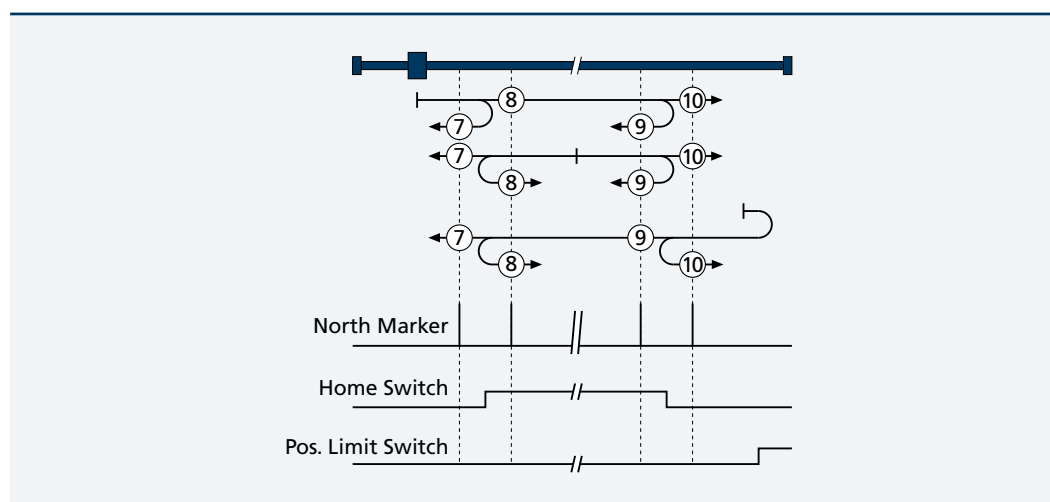

Rotary table function

When controlling a rotary working table target position is calculated and reached within one revolution. Rotary table function enables the drive to detect the shortest way to reach the desired angular position, considering the shaft revolutions needed to do a complete table rotation.

Best sense of rotation, clockwise or anti-clockwise can also be detected, in order to minimize travel time and distance.

Jog and teach-in functions

In "jog mode" drive can be freely moved at fixed speed in both directions through the "manual" set of assigned digital inputs.

During jog mode, several target positions can be approached and saved through Teach-in function: when desired position is reached, teach-in function allows to take over actual position in the active travel record as target position.



Servo package

When using Active Cube in servo applications, you can get the best out of the drive when applied together with Bonfiglioli servomotors. Active Cube and Bonfiglioli servomotors were, in fact, designed to exploit at best reciprocal synergies thus forming a servo "package", able to provide significant advantages to users both in terms of enhanced performance and in terms of reduced setup time.

The Bonfiglioli servo system benefits from several specific solutions, involving the 2 product series:

- Active Cube has a preloaded parameter profile of Bonfiglioli servomotors.
- Wiring the drive to motor is easier thanks to the availability of factory pre-wired cables and connectors.
- "Motion" functions are readily available



Bonfiglioli servomotors range

Bonfiglioli servomotors offer includes 2 series of permanent magnet synchronous servomotors, BTD (Bonfiglioli Torque Density) and BCR (Bonfiglioli Classic Range) featured by different speed and torque ranges, achieved through different construction technologies.

BTD and BCR series are split into many frame sizes, each of them grouping together devices with same flange dimensions and different motor lengths able to supply different torque ratings within one frame size.

BCR devices are designed to provide a wide rated torque range up to 115 Nm and peak torque up to 400%.

BTD devices, fulfil the need of high torque in small motor dimensions. Innovative construction technology, together with high quality of magnets used allows BTD servomotors achieving a "torque density of 15.3 Nm/dm³."

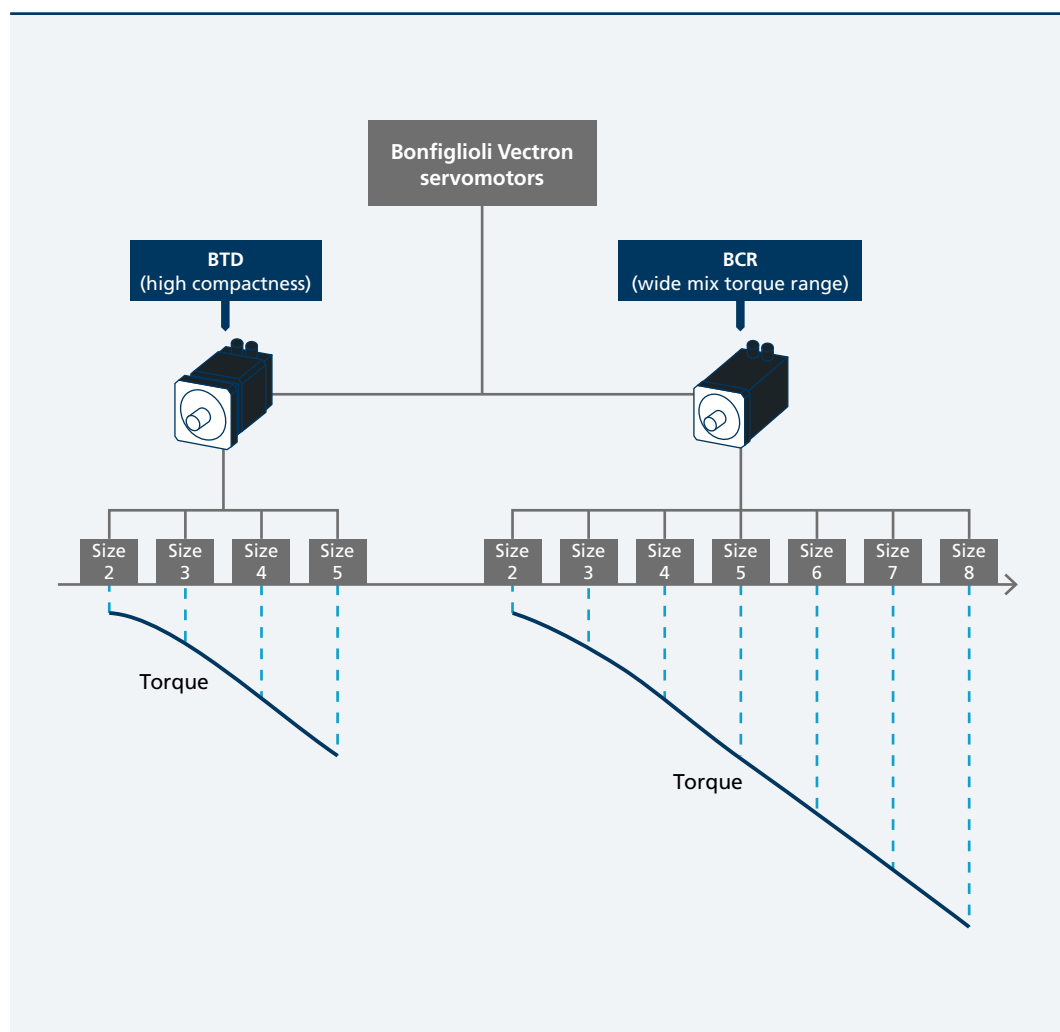

ACU 230V ◀▶ BTD 230V

BTD...		2-0026	2-0053	2-0074	2-0095	3-0095	3-0190	3-0325	3-0420
Active Cube drive									
ACU201-01	M_n	0.25	0.42	0.45		0.65			
	M_{max}	0.74	0.84	0.89		1.29			
ACU201-03	M_n		0.47	0.69	0.72	0.92	1.09		
	M_{max}		1.35	1.43	1.45	2.07	2.17		
ACU201-05	M_n			0.69	0.86	0.92	1.63		2.63
	M_{max}			2.01	2.04	2.91	3.05		3.94
ACU201-07	M_n			0.69	0.86	0.92	1.63	3.02	3.24
	M_{max}			2.67	2.71	3.49	4.07	4.53	5.25
ACU201-09	M_n				0.86		1.63	3.02	3.24
	M_{max}				3.30		4.95	5.52	6.39
ACU201-11	M_n						3.02	3.24	
	M_{max}						7.94	9.19	
ACU201-13	M_n						3.02	3.24	
	M_{max}						10.81	12.51	
ACU201-15	M_n								
	M_{max}								
ACU201-18	M_n								
	M_{max}								
ACU201-19	M_n								
	M_{max}								
ACU201-21	M_n								
	M_{max}								
ACU201-22	M_n								
	M_{max}								

Note:

Continuous torque

Max torque

For servomotor ratings and description, please refer to relevant catalogue.

This table helps you to do mentative evaluation of motor and drive matches: for final dimensioning and selection of motor and drive please refer to servomotor ratings in relevant catalogue.

4-0410	4-0630	4-0860	5-1160	5-1490	5-1870	5-2730
2.73						
4.10						
3.42						
4.99						
3.42	4.83	5.38				
7.18	7.25	8.06				
3.42	4.83	6.37				
9.77	9.87	10.98				
3.42	4.83	6.37	8.38	9.27		
11.14	11.25	12.52	10.93	12.08		
	4.83	6.37	8.85	11.56		
	18.15	20.19	17.63	19.50		
		6.37	8.85	11.56	14.75	18.54
		23.27	20.32	22.46	20.31	25.53
			8.85	11.56	15.01	21.40
			29.84	32.99	29.83	37.50
			8.85	11.56	15.01	21.40
			34.53	38.18	34.52	43.39

ACU 400V BTD 400V

BTD...		2-0026	2-0053	2-0074	2-0095	3-0095	3-0190	3-0325	3-0420
Active Cube drive									
ACU401-01	M_n	0.42	0.48	0.69	0.73	0.72	1.14		
	M_{max}	1.05	1.45	1.54	1.45	1.44	2.29		
ACU401-03	M_n			0.69	0.86	0.92	1.67		
	M_{max}			2.47	2.32	2.30	3.66		
ACU401-05	M_n			0.69	0.86	0.92	1.67	2.44	2.52
	M_{max}			2.08	1.96	1.94	3.09	3.66	3.78
ACU401-07	M_n				0.86	0.92	1.67	3.11	3.22
	M_{max}				2.61	2.59	4.12	4.88	5.04
ACU401-09	M_n					0.92	1.67	3.11	3.22
	M_{max}					3.45	5.49	6.50	6.72
ACU401-11	M_n						1.67	3.11	3.22
	M_{max}						6.52	7.72	7.98
ACU401-12	M_n							3.11	3.22
	M_{max}							8.53	8.82
ACU401-13	M_n							3.11	3.22
	M_{max}							11.78	12.18
ACU401-15	M_n								
	M_{max}								
ACU401-18	M_n								
	M_{max}								
ACU401-19	M_n								
	M_{max}								
ACU401-21	M_n								
	M_{max}								
ACU401-22	M_n								
	M_{max}								
ACU401-23	M_n								
	M_{max}								
ACU401-25	M_n								
	M_{max}								

Note:

Continuous torque

Max torque

For servomotor ratings and description, please refer to relevant catalogue.

This table helps you to do mentative evaluation of motor and drive matches: for final dimensioning and selection of motor and drive please refer to servomotor ratings in relevant catalogue.

4-0410	4-0630	4-0860	5-1160	5-1490	5-1870	5-2730
2.89						
4.34						
3.38	4.23					
5.79	6.34					
3.38	4.75					
6.87	7.53					
3.38	4.75	5.64				
7.60	8.32	8.47				
3.38	4.75	6.45				
10.49	11.49	11.69				
	4.75	6.45	8.70			
	15.45	15.72	13.05			
	4.75	6.45	8.81	10.73	10.26	
	17.83	18.14	15.06	16.09	15.39	
			8.81	11.44	14.94	20.12
			23.42	25.03	23.95	30.17
			8.81	11.44	14.94	21.41
			29.33	31.35	29.99	37.79
			8.81	11.44	14.94	21.41
			33.80	36.12	34.55	43.54
				11.44	14.94	21.41
				44.70	42.76	53.88
					14.94	21.41
					50.74	63.94

ACU 230V BCR 230V

BCR... 2-0020 2-0040 2-0060 2-0080 3-0065 3-0130 3-0250 3-0300 4-0100 4-0260 4-0530 4-0750

Active Cube drive

ACU201-01	M_n	0.20	0.38	0.49	0.51	0.47							
	M_{max}	0.68	0.86	0.98	1.03	0.94							
ACU201-03	M_n		0.38	0.58	0.75	0.62	0.87			0.87			
	M_{max}		1.38	1.56	1.64	1.51	1.73			1.75			
ACU201-05	M_n			0.58	0.75	0.62	1.08	1.88	1.88	0.98	2.52		
	M_{max}			2.20	2.31	2.12	2.44	2.81	2.81	2.46	3.77		
ACU201-07	M_n				0.75		1.08	2.13	2.25	0.98	2.52		
	M_{max}				3.08		3.25	3.75	3.75	3.28	5.03		
ACU201-09	M_n						1.08	2.13	2.25		2.52	4.40	
	M_{max}						3.95	4.56	4.56		6.12	5.95	
ACU201-11	M_n							2.13	2.25		2.52	4.81	5.77
	M_{max}							6.56	6.56		8.81	8.56	8.65
ACU201-13	M_n								2.25			4.81	6.68
	M_{max}								8.94			11.66	11.79
ACU201-15	M_n											4.81	6.68
	M_{max}											13.29	13.43
ACU201-18	M_n												6.68
	M_{max}												21.68
ACU201-19	M_n												6.68
	M_{max}												24.97
ACU201-21	M_n												
	M_{max}												
ACU201-22	M_n												
	M_{max}												

Note:

- Continuous torque
- Max torque

For servomotor ratings and description, please refer to relevant catalogue.

This table helps you to do mentative evaluation of motor and drive matches: for final dimensioning and selection of motor and drive please refer to servomotor ratings in relevant catalogue.

5-0660 5-1050 5-1350 5-1700 5-2200 6-1350 6-1900 6-2200 6-2900 7-2700 7-3200 7-4000

4.63												
6.26												
5.83												
9.00												
5.83	7.44											
12.26	11.21											
5.83	9.01	9.70	11.55		11.56							
13.97	12.77	12.65	15.06		15.07							
5.83	9.01	11.25	14.78	15.47	13.50	14.87						
22.54	20.61	20.41	24.30	22.60	24.32	21.73						
	9.01	11.25	14.78	17.36	13.50	17.60	18.91	20.38	21.06	21.46	20.00	
	23.74	23.51	27.99	26.04	28.02	25.03	26.04	28.07	29.01	29.56	27.55	
	9.01	11.25	14.78	17.36	13.50	17.60	19.68	24.83	22.69	25.27	28.91	
	34.87	34.53	41.11	38.24	41.15	36.76	38.24	41.23	42.61	43.41	40.45	
		11.25	14.78	17.36	13.50	17.60	19.68	24.83	22.69	25.27	28.91	
		39.96	47.58	44.26	47.62	42.54	44.26	47.72	49.31	50.24	46.82	

ACU 400V BCR 400V

BCR... 2-002 2-0040 2-0060 2-0080 3-0065 3-0130 3-0250 3-0300 4-0100 4-0260 4-0530 4-0750 5-0660

Active Cube drive

ACU401-01	M_n	0.20	0.38	0.58	0.76	0.62	0.91			0.94				
	M_{max}	0.85	1.48	1.64	1.76	1.65	1.82			1.89				
ACU401-03	M_n			0.58	0.76	0.62	1.13			0.99				
	M_{max}			2.55	2.81	2.63	2.91			3.02				
ACU401-05	M_n			0.58	0.76	0.62	1.13	1.73	2.08	0.99	2.44			
	M_{max}			2.22	2.37	2.22	2.45	2.60	3.12	2.55	3.66			
ACU401-07	M_n				0.76		1.13	2.12	2.31	0.99	2.51			
	M_{max}				3.16		3.27	3.46	4.15	3.40	4.88			
ACU401-09	M_n						1.13	2.12	2.31		2.51			
	M_{max}						4.36	4.62	5.54		6.50			
ACU401-11	M_n							2.12	2.31		2.51	4.91		5.57
	M_{max}							5.48	6.58		7.72	7.37		8.36
ACU401-12	M_n							2.12	2.31		2.51	4.91	6.56	5.87
	M_{max}							6.06	7.27		8.53	8.14	9.84	9.24
ACU401-13	M_n							2.12				4.91	6.88	5.87
	M_{max}							8.37				11.25	13.59	12.76
ACU401-15	M_n											4.91	6.88	5.87
	M_{max}											15.12	18.28	17.16
ACU401-18	M_n											4.91	6.88	5.87
	M_{max}											17.45	21.09	19.80
ACU401-19	M_n													
	M_{max}													
ACU401-21	M_n													
	M_{max}													
ACU401-22	M_n													
	M_{max}													
ACU401-23	M_n													
	M_{max}													
ACU401-25	M_n													
	M_{max}													
ACU401-27	M_n													
	M_{max}													
ACU401-29	M_n													
	M_{max}													
ACU401-31	M_n													
	M_{max}													
ACU401-33	M_n													
	M_{max}													

Note:

- Continuous torque
- Max torque

For servomotor ratings and description, please refer to relevant catalogue.

This table helps you to do mentative evaluation of motor and drive matches: for final dimensioning and selection of motor and drive please refer to servomotor ratings in relevant catalogue.

Mounting

A wide range of mechanical accessories is available for Active Cube Series frequency converters, to make installation extremely easy in all sorts of applications.

In standard mountings the unit can be installed directly on the mounting plate or through-the-wall. A vibration-proof mounting variant and a standard DIN bar mounting variant are also available.

The range of mounting variants also includes an optional support with shielded brackets, so that the right solution for all possible needs can always be found.

Installations are practically identical for all sizes, so the examples shown below can be taken as representative solutions and ideal for all installers seeking a mechanically simple, compact installation solution.

Types of mounting kits

The drive is supplied complete with a standard installation kit for fixing to an electrical cabinet mounting panel.

3 different optional installation kits are available on request.

MPSV

Thru-type assembly for higher protection classes or enhanced cooling characteristics

MNVIB

Anti-vibration mounting for installations on machines that generate significant vibrational stress

MDIN

DIN rail assembly for fast and modular installation / coupling

Size 1

Inverter Bonfiglioli	Mounting	Description
ACU 201-01 ... ACU 201-09 ACU 401-01 ... ACU 401-11	MPSV1	Thru-type assembly
	MNVIB1	Antivibration assembly
	MDIN1	DIN rail assembly

Standard assembly

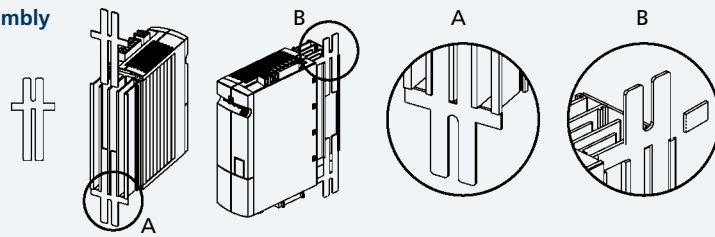

MPSV1

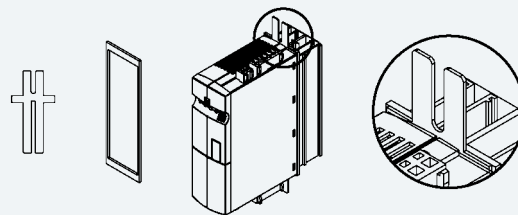

MNVIB1

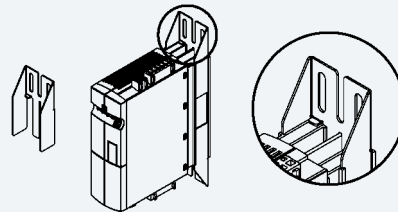

MDIN1

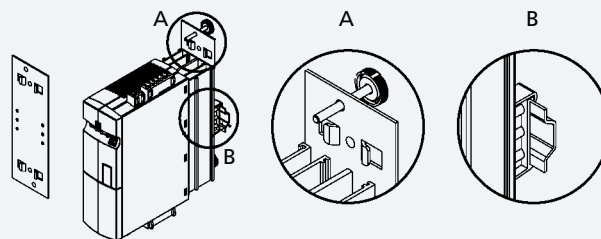

Size 2

Inverter Bonfiglioli	Mounting	Description
ACU 201-11 ... ACU 201-15 ACU 401-12 ... ACU 401-18	MPSV2	Thru-type assembly
	MNVIB2	Antivibration assembly
	MDIN2	DIN rail assembly

Standard assembly

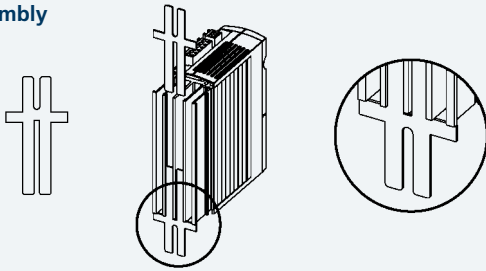

MPSV2

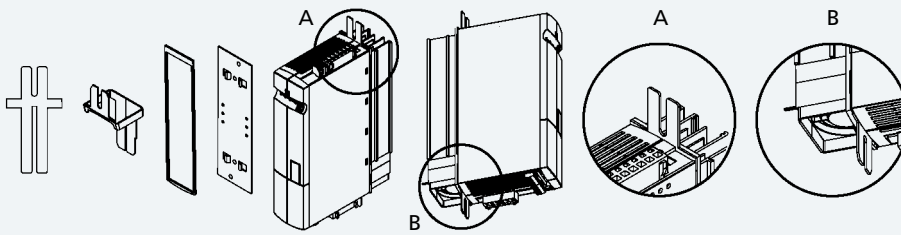

MNVIB2

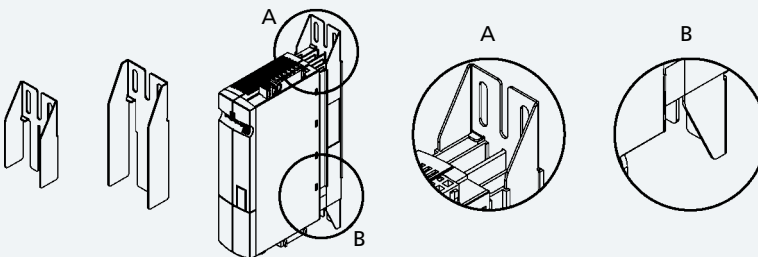

MDIN2

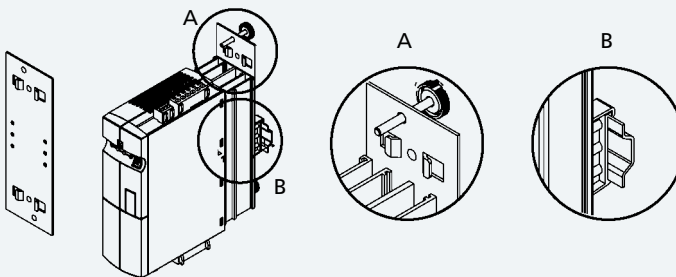

Size 3

Inverter Bonfiglioli	Mounting	Description
ACU 201-18 ... ACU 201-19 ACU 401-19 ... ACU 401-22	MPSV3	Thru-type assembly
	MNVIB3	Antivibration assembly

Standard assembly

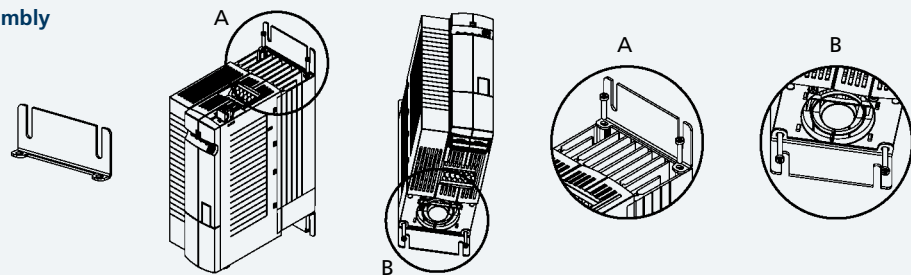

MPSV3

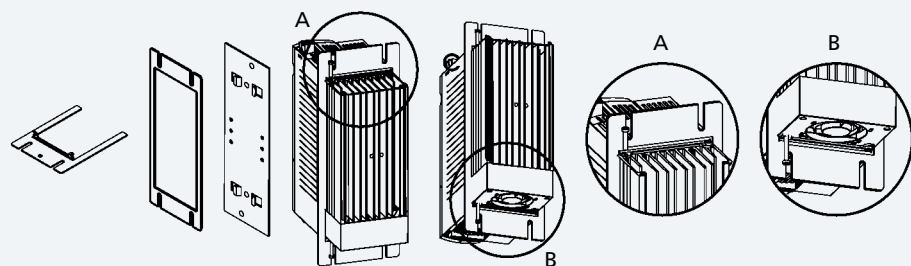

MNVIB3

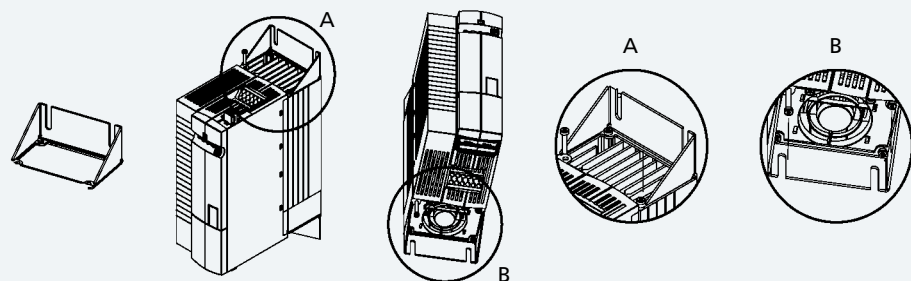

Size 4

Inverter Bonfiglioli	Mounting	Description
ACU 201-21 ... ACU 201-22	MPSV4	Thru-type assembly
ACU 401-23 ... ACU 401-25	MNVIB4	Antivibration assembly

Standard assembly

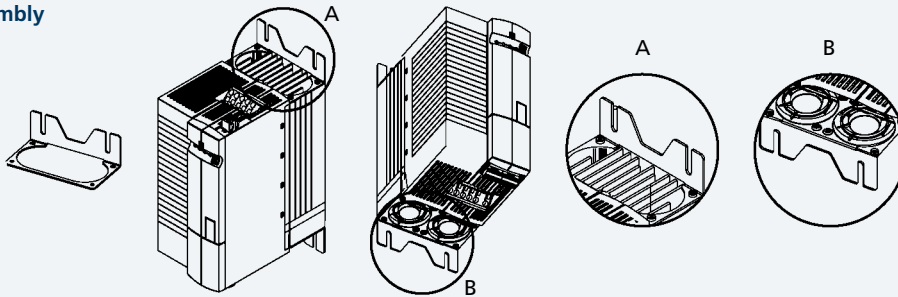

MPSV4

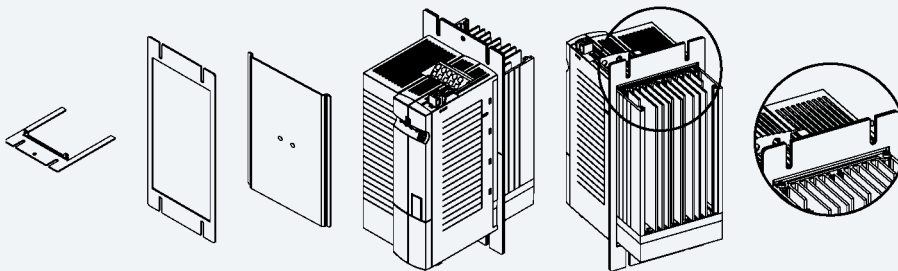

MNVIB4

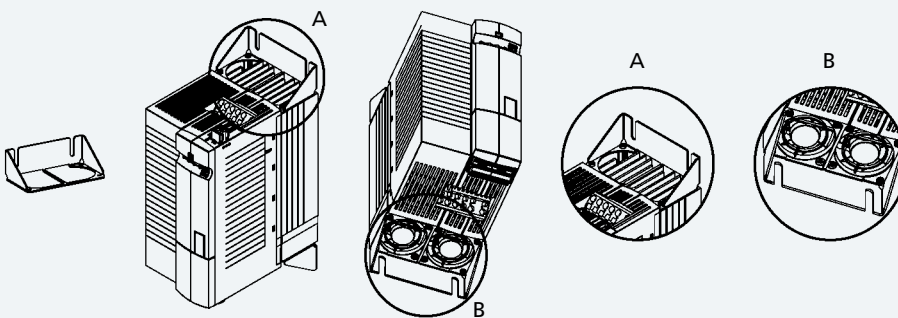

Size 5

Inverter Bonfiglioli	Mounting	Description
ACU 401-27 ... ACU 401-31	MPSV5	Thru-type assembly
	MNVIB5	Antivibration assembly

Standard assembly

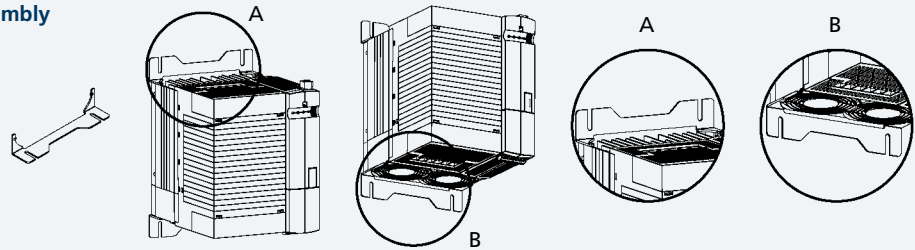

MPSV5

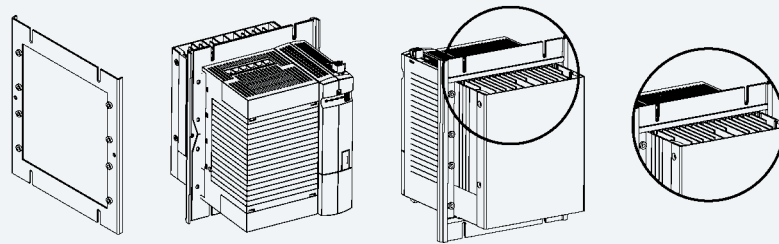

MNVIB5

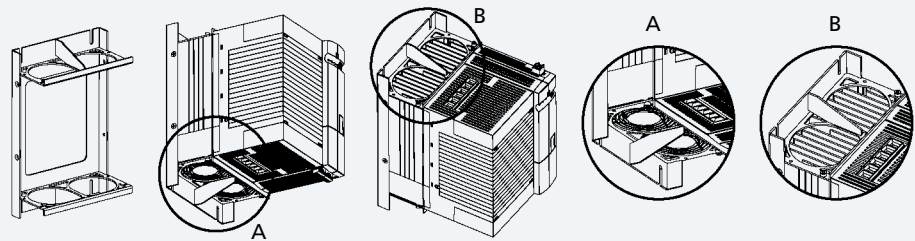

Size 6

Inverter Bonfiglioli	Mounting	Description
ACU 401-33 ... ACU 401-39	MPSV6	Thru-type assembly
	MNVIB6	Antivibration assembly

Standard assembly

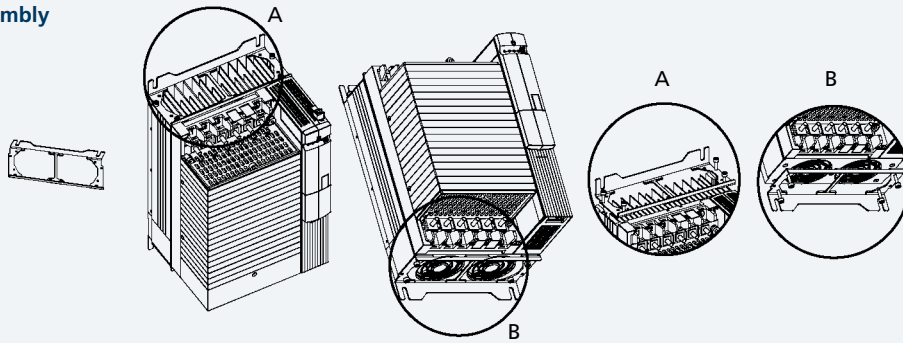

MPSV6

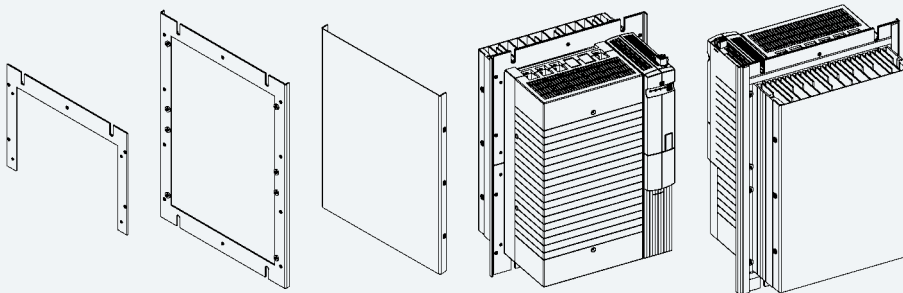

MNVIB6

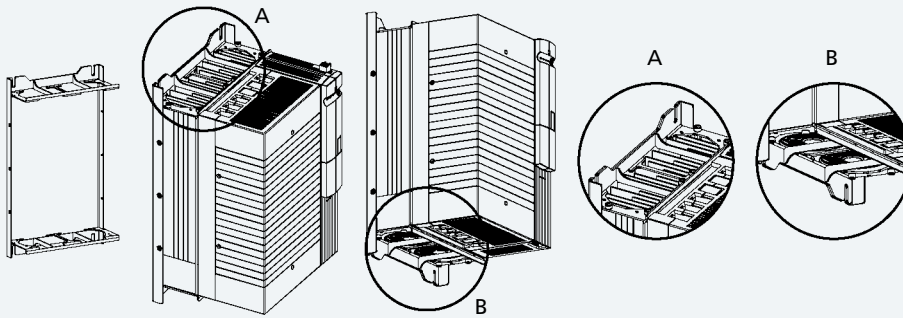

Size 7

Inverter Bonfiglioli	Mounting	Description
ACU 401-43 ... ACU 401-49	MPSV7	Thru-type assembly

Standard assembly

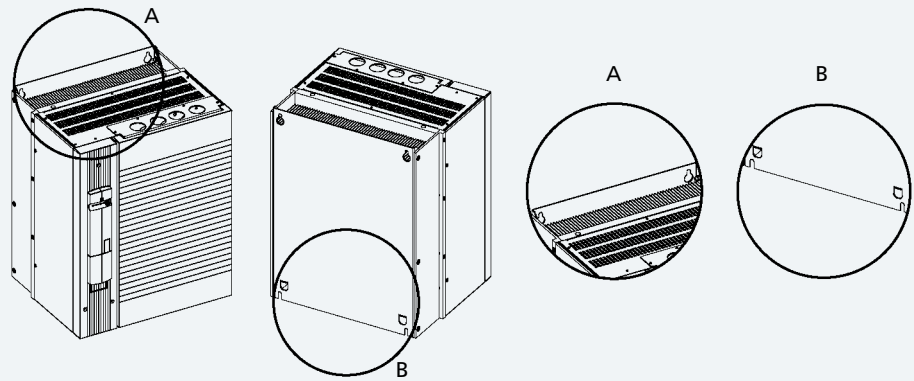

MPSV7

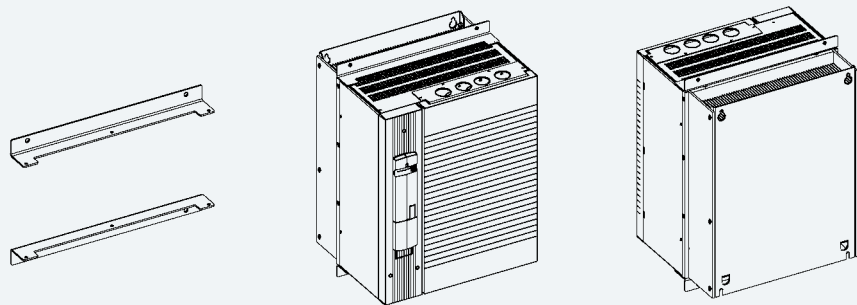

Input filter

Why an input filter?

An Input Filter is a filtration device to be installed up-line from the frequency inverter and down-line from the power feeding contactor.

The AC/DC rectifier at the inverter input generates harmonic disturbance on the absorbed current and returns disturbance generated by switching components towards the mains.

This harmonic current causes voltage distortions on the mains resulting in electromagnetic interference phenomena.

This harmonic distortion is reduced by means of line chokes, while disturbance is countered with EMI filters (attenuation of EMI voltages) such as those described below.

Note: the use of input filters reduces the inverter input voltage. If required, these filters should be installed up-line from the inverter in the following order:

1. Mains supply
2. Line choke
3. EMI filter
4. Inverter

Line choke

- Line chokes are not mandatory: their use depends on the system engineer's need to reduce harmonic distortion in the short circuit point, and the need to reinforce the action of the EMI filter. A line choke is normally used if the mains short circuit power is lower than 1%.

- A line choke is recommended for the ACU201 and ACU401 frequency inverter series in the presence of high continuous input current required by the application, in order to increase the lifetime of the electrolytic capacitors.

- A line choke is always required in single and two-phase operation of the ACU201 frequency inverters.

EMI filter

- An EMI filter can be used in order to achieve Class "A" (groups 1, 2) or Class "B" interference suppression

- The EMI filter is available in a low leakage current version for special applications.

- The EMI - filter is part of the standard outfit in sizes of up to 4.0 kW and it is supplied as an optional for higher sizes in an internal (up to 7.5 kW) or external (above 7.5 kW) version.

ACTIVE CUBE inverter - Line choke / EMI filter combination

Motor cable length	Compliance with Class A (Group 2)		Compliance with Class A (Group 1)		Compliance with Class B	
	< 10 m	< max*	< 10 m	< max*	< 10 m	< max*
ACU 1 (standard internal filter)	Standard	external choke	external choke	external filter	external choke	external filter
ACU 2 (standard internal filter)	Standard	external choke	external choke	external filter	external choke	external filter
ACU 3	internal filter or external choke	internal filter or external choke	internal filter + external choke	internal filter + external choke	internal filter + external choke	external filter
ACU 4	external choke	external choke	external filter	external filter	external filter	external filter + external choke
ACU 5	external choke	external choke	external filter	external filter	external filter	external filter + external choke
ACU 6	external choke	external choke	external filter	external filter	external filter	external filter
ACU 7	external choke	external filter	external filter	external filter	—	—

* See the operation manual

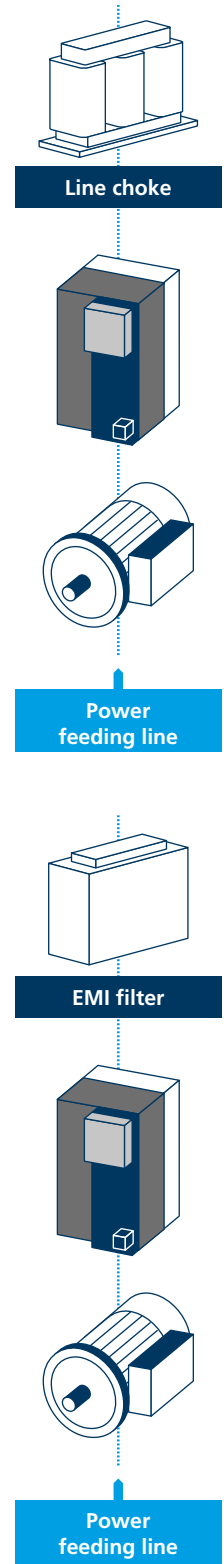



Line choke

The simplest way of reducing high harmonic components and hence reactive power is connecting a choke in series on the mains side of the inverter. Depending on the system, reactive power consumption can be reduced by approximately 20% of the figure without line choke.

The line choke increases inductance towards the mains. Mains feed line choke can be regarded as sufficient if short-circuit power is from 20 to 40 times higher than the inverter nominal output.

The inverter is suitable for connection to public or industrial mains supplies in compliance with technical data. If the supply mains transformer output is ≤ 500 kVA, the optional mains choke is needed only if specified in the inverter technical data. The other inverters are suitable for the connection to the mains without a mains choke with relative impedance $\geq 1\%$. If it is desired to connect more than one inverter, use the sum of the nominal outputs as a basis.

Since experience has shown that the nominal short circuit power on the inverter connection point is often unknown, BONFIGLIOLI recommends the use of mains chokes with 4% voltage drop.

The relative short circuit voltage equivalent to a 4% voltage drop represents the percentage of the nominal voltage at which a current equal to rated current flows in the case of a short circuit.

The European reference standard for harmonics is EN 60 555, while in the US and Canada systems must comply with standard IEEE 519 and various generic national regulations.

The line choke must be installed between the mains connection point and the EMI filter. Both the line choke and inverter should be installed on a common metal baseplate and each should be connected to the metal mounting plate and earthed by means of a large contact area copper braid.

Technical data

Nominal voltages

230V +/- 10%
400V +/- 10%

Frequencies

50/60 Hz
uk (a IN / 50 Hz) 4%

Insulating material class

T40/F

Ambient temperature

40°C

Protection class

IP00 / VBG4

Connection type

Contact-protected terminals

Line choke

Dimensions

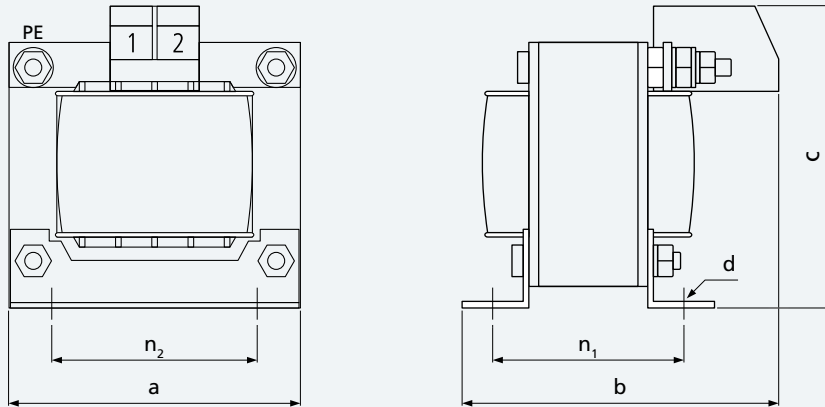

Technical data

Bonfiglioli frequency inverter - Line choke combination, 1x230V~

Bonfiglioli inverter	Bonfiglioli choke	Nominal current	Power dissipation
		[A]	[W]
ACU 201-01	LCVS006	6	8.0
ACU 201-03			
ACU 201-05			
ACU 201-07	LCVS008	8	8.0
ACU 201-09	LCVS010	10	10.0
ACU 201-11	LCVS015	15	12.0
ACU 201-13	LCVS018	18	15.0

Technical assembly data

Bonfiglioli choke	Dimensions			Assembly			Weight	Connection terminal		
	a [mm]	b [mm]	c [mm]	n ₂ [mm]	n ₁ [mm]	d [mm]	[kg]	[mm]	[Nm]	PE
LCVS006	60	62	75	44	38	3.6	0.5	0.75-2.5	1.0-1.2	2.5 mm ²
LCVS008	60	67	75	44	43	3.6	0.6	0.75-2.5	1.0-1.2	2.5 mm ²
LCVS010	66	80	70	50	51	4.8	0.8	0.75-2.5	1.0-1.2	M4
LCVS015	78	78	80	56	49	4.8	1.1	0.75-4.0	1.5-1.8	M4
LCVS018	85	85	95	64	50	4.8	1.8	0.75-4.0	1.5-1.8	M4

Line choke

Dimensions

LCVT004 ... LCVT025

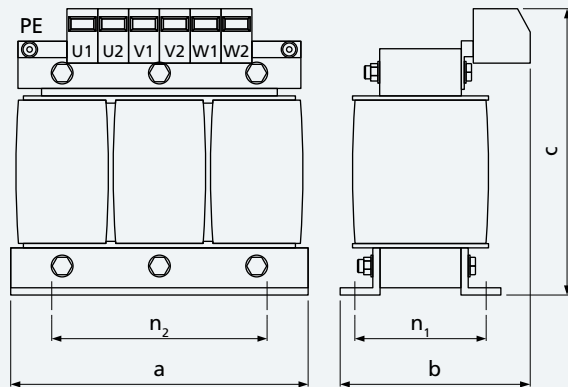

LCVT034 ... LCVT250

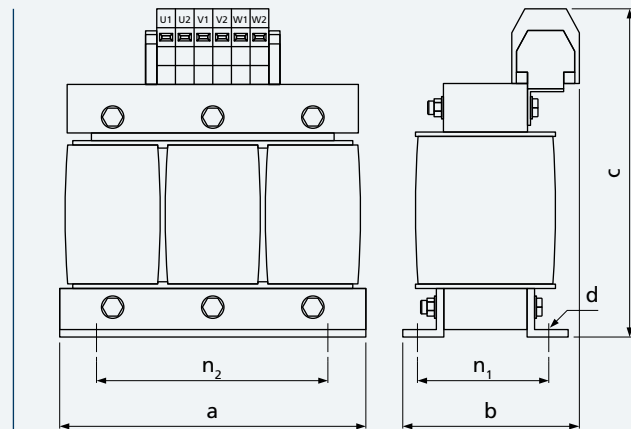

Technical data

Bonfiglioli frequency inverter – Line choke combination, 3x230V~

Bonfiglioli inverter	Bonfiglioli choke	Nominal current	Choke	Power dissipation
		[A]	[mH]	[W]
ACU 201-01	LCVT004	4	7.32	20
ACU 201-03				
ACU 201-05				
ACU 201-07				
ACU 201-09	LCVT006	6	4.88	25
ACU 201-11	LCVT008	8	3.66	30
ACU 201-13	LCVT010	10	2.93	30
ACU 201-15	LCVT015	15	1.95	45
ACU 201-18	LCVT018	18	1.63	70
ACU 201-19	LCVT025	25	1.17	70
ACU 201-21	LCVT034	34	0.86	85
ACU 201-22				

Line choke

Technical data

Bonfiglioli frequency inverter – Line choke combination, 3x400V~

Bonfiglioli inverter	Bonfiglioli choke	Nominal current	Choke	Power dissipation
		[A]	[mH]	[W]
ACU 401-01	LCVT004	4	7.32	20
ACU 401-03				
ACU 401-05				
ACU 401-07				
ACU 401-09				
ACU 401-11				
ACU 401-12				
ACU 401-13	LCVT006	6	4.88	25
ACU 401-15	LCVT008	8	3.66	30
ACU 401-18	LCVT010	10	2.93	30
ACU 401-19	LCVT015	15	1.95	45
ACU 401-21	LCVT018	18	1.63	70
ACU 401-22	LCVT025	25	1.17	70
ACU 401-23	LCVT025	25	0.86	85
ACU 401-25	LCVT034	34	0.86	85
ACU 401-27	LCVT050	50	0.59	100
ACU 401-29	LCVT060	60	0.49	100
ACU 401-31				
ACU 401-33	LCVT075	75	0.37	110
ACU 401-35	LCVT090	90	0.33	120
ACU 401-37	LCVT115	115	0.25	140
ACU 401-39	LCVT135	135	0.22	180
ACU 401-43	LCVT160	160	0.18	180
ACU 401-45	LCVT180	180	0.16	185
ACU 401-47	LCVT210	210	0.14	200
ACU 401-49	LCVT250	250	0.12	210

Technical assembly data

Bonfiglioli choke	Dimensions			Assembly			Weight	Connection terminal		
	a [mm]	b [mm]	c [mm]	n ₂ [mm]	n ₁ [mm]	d [mm]	[kg]	[mm]	[Nm]	PE
LCVT004	80	65	95	55	37	4	0.8	0.75-2.5	1.0-1.2	4 mm ²
LCVT006	100	65	115	60	39	4	1.0	0.75-2.5	1.0-1.2	4 mm ²
LCVT008	100	75	115	60	48	4	1.5	0.75-2.5	1.0-1.2	4 mm ²
LCVT010	100	75	115	60	48	4	1.5	0.75-2.5	1.0-1.2	4 mm ²
LCVT015	125	85	135	100	55	5	3.0	0.75-4.0	1.5-1.8	4 mm ²
LCVT018	155	90	135	130	57	8	4.0	0.75-4.0	1.5-1.8	4 mm ²
LCVT025	155	100	160	130	57	8	4.0	0.75-10	4.0-4.5	4 mm ²
LCVT034	155	100	190	130	57	8	4.5	2.5-16	2.0-4.0	M5
LCVT050	155	115	190	130	72	8	4.5	2.5-16	2.0-4.0	M5
LCVT060	190	110	220	170	58	8	9.0	2.5-35	2.5-5.0	M5
LCVT075	190	120	250	170	68	8	12	25-50	3.0-6.0	M6
LCVT090	190	130	250	170	78	8	12	25-50	3.0-6.0	M6
LCVT115	210	140	270	180	82	8	14	25-50	3.0-6.0	M6
LCVT135	240	160	300	190	100	11	20	16-70	6.0-7.0	M8
LCVT160	240	160	310	190	100	11	20	50-95	6.0-12.0	M8
LCVT180	240	175	320	190	106	11	22	50-95	6.0-12.0	M8
LCVT210	240	200	335	190	121	11	26	95-150	10.0-20.0	M8
LCVT250	240	210	350	190	126	11	28	95-150	10.0-20.0	M8

EMI filters

Because of their intrinsic characteristics, all frequency inverters often generate undesired high frequency voltages generally referred to as "interference". Mains filters are installed to reduce this interference. Within the European Union reference standard EN EN61800-3 defines the thresholds for electromagnetic interference for different classes of equipment. Active Cube series frequency inverters up to size 9.2 kW can be ordered with a built-in EMI filter conforming to the requirements of the standard for "class A – group 2" environments. Two series of external interference filters are available for larger size Active Cube frequency inverters and

for installations where conformity to the stricter requirements of class B is necessary. The two series differ both in construction and power range. The first set of filters are "backplate filters or foot print". They are available in sizes 7 to 40 A (suitable for Active Cube frequency inverters up to size 4), and allow the frequency inverter to be installed on board the filter itself. The second series of filters are "book filters". They cover all other Active Cube sizes up to 130 A and are designed for installation on the same mounting panel alongside the drive. Mains filters with very low dispersion currents are available upon request for specific applications.

Basic circuit diagram

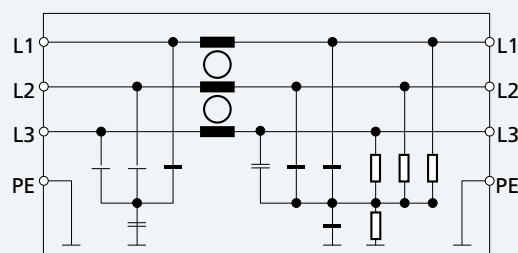
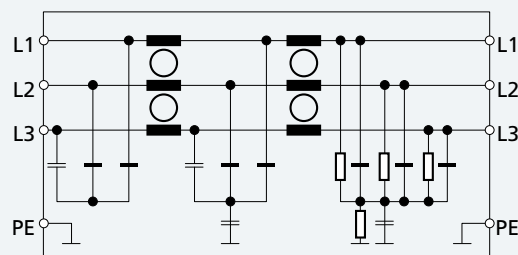

Backplate EMI filters

Mains voltage

3 x 480V~ maximum +10%

Nominal current

8A ... 40A

Frequency

50/60 Hz

Operating and storage temperature

-25 °C ... +100 °C (climate class acc. to CEI 25/100/21)

Ambient temperature

+40°C maximum

Protection class

IP00

Connection type

Contact-protected terminals

Strand connection on load side (only up to ACU 401-18)

Metal fasteners are included in the supply

Note

These mains filters are installed between the line choke and the frequency inverter. The frequency inverter installed on the EMI filter must be connected to the metal baseplate with a short, large section earth connection.

Overload capacity is 1.5 times rated current for 1 minute, every 30 minutes.

Bonfiglioli Inverter		Bonfiglioli EMI filter	Rated current	Leakage current	Power dissipation	Weight
Size	Type		[A]	[mA]	[W]	[kg]
1	ACU 201-01	FTV007B	8	5	10	1.5
	ACU 201-03					
	ACU 201-05					
	ACU 201-07					
	ACU 201-09					
	ACU 401-01					
	ACU 401-03					
	ACU 401-05					
	ACU 401-07					
	ACU 401-09					
	ACU 401-11					
2	ACU 201-11	FTV018B	18	1.5	20	3.5
	ACU 401-12					
	ACU 401-13					
	ACU 401-15					
	ACU 401-18					
3	ACU 401-19	FTV040B	40	1.2	35	3.5
	ACU 401-21					
4	ACU 401-23	FTV040B	40	1.2	35	3.5
	ACU 401-25					

Backplate EMI filters

Dimensions FTV007B

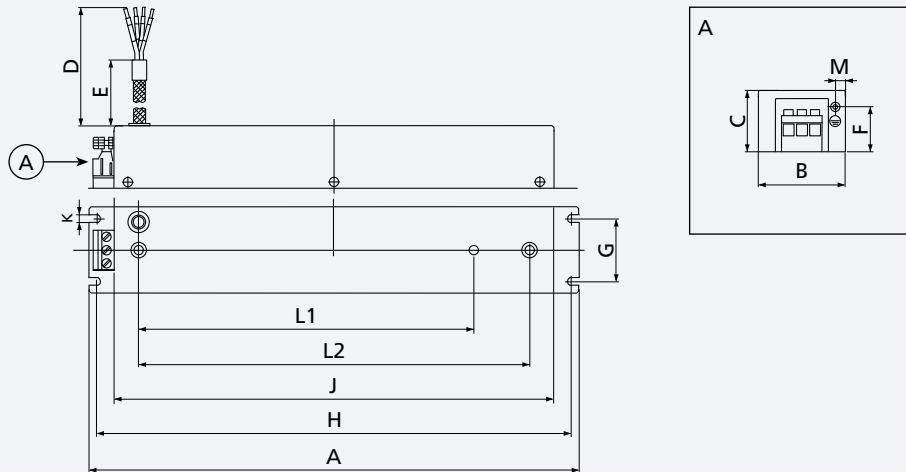

EMI filter	A	B	C	D	E	F	G	H	J	K	L1	L2	M
[mm]													
FTV007B	351	62	45	200±10	160±10	33	45±0.2	340±0.3	315	5.5	240±0.2	280±0.2	7

Dimensions FTV018B - FTV040B

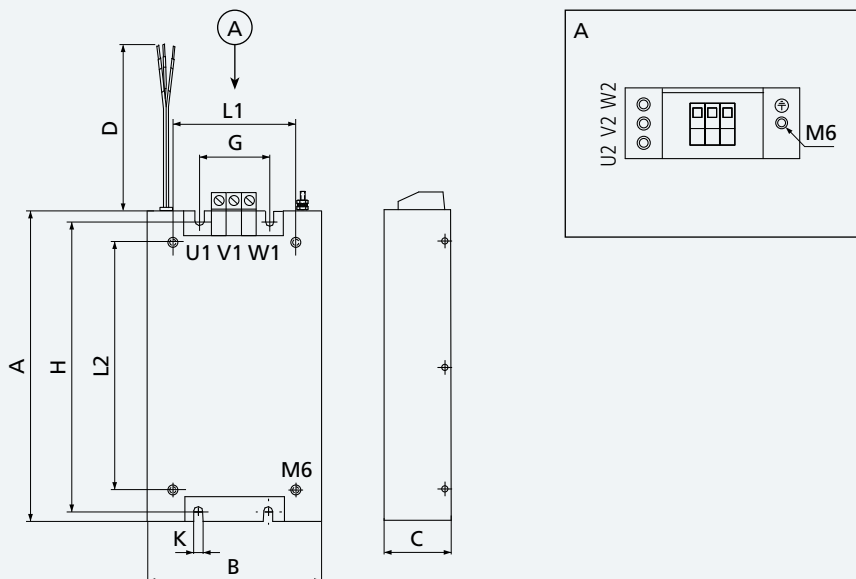

EMI filter	A	B	C	D	G	H	K	L1	L2
[mm]									
FTV018B	315	100	65	300	35	300	6.3	76	270
FTV040B	315	125	65	300	60	300	6.3	125	270

Book type EMI filters

Mains voltage

3 x 480 VAC

Rated current

7 A ... 130 A

Frequency

up to 60 Hz

Operating and storage temperature

-25 °C ... +80 °C (climate class acc. to CEI 25/80/21)

Type of protection

IP20

Maximum length of motor cables:

ACU 401-01 to -15: 25 m class B

ACU 401-18 to -25: 50 m class B

ACU 401-27 to -39: 10 m class B, 100 m class A group 1

ACU 401-43 to -49: 10 m class B, 100 m class A group 1

Note

Overload capacity is 4 times rated current at switch-on; 1.5 times rated current for 1 minute, once per hour.

Bonfiglioli Inverter		Bonfiglioli EMI filter	Rated current	Leakage current	Power dissipation	Weight
Size	Type		[A]	[mA]	[W]	[kg]
1	ACU 201-01	FTV007A	7		3.8	0.5
	ACU 201-03					
	ACU 201-05					
	ACU 201-07					
	ACU 201-09					
	ACU 401-01					
	ACU 401-03					
	ACU 401-05					
	ACU 401-07					
	ACU 401-09					
	ACU 401-11					
2	ACU 201-11	FTV016A	16	33	6.1	0.8
	ACU 401-12					
	ACU 401-13					
	ACU 401-15					
	ACU 201-13					
3	ACU 201-13	FTV030A	30		11.8	1.2
	ACU 201-15					
	ACU 401-18					
	ACU 401-19					
4	ACU 401-21	FTV055A	55		25.9	2.0
	ACU 201-21					
	ACU 401-23					
5	ACU 401-25	FTV075A	75		32.2	2.7
	ACU 201-22					
6	ACU 401-27	FTV100A	100		34.5	4.3
	ACU 401-29					
	ACU 401-31					
7	ACU 401-33	FTV130A	130		43.1	4.5
	ACU 401-35					
	ACU 401-37					
	ACU 401-39					
	ACU 201-22	FTV180A	180	33	58.3	6.0
	ACU 401-27					
	ACU 401-29					
	ACU 401-31					
	ACU 401-43	FTV250A	250	98	90	12.4
	ACU 401-45					
	ACU 401-47					
	ACU 401-49					

Book type EMI filters

Dimensions FTV007A ... FTV180A

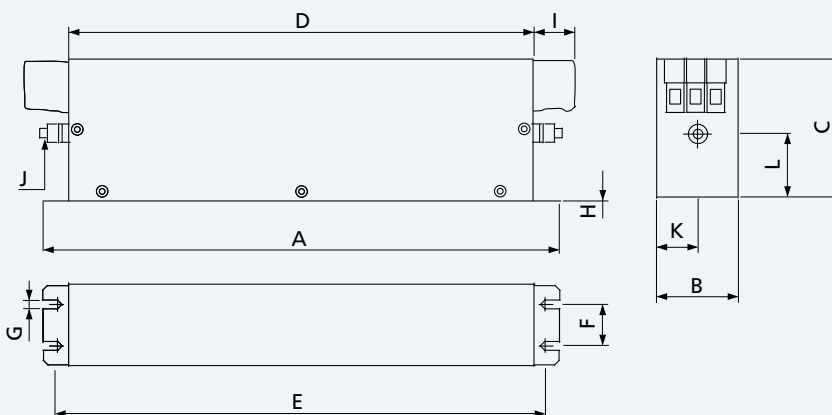

EMI filter	A	B	C	D	E	F	G	H	I	J	K	L
[mm]												
FTV007A	190	40	70	160	180	20	4.5	1	22	M5	20	29.5
FTV016A	250	45	70	220	235	25	5.4	1	22	M5	22.5	29.5
FTV030A	270	50	85	240	255	30	5.4	1	25	M5	25	39.5
FTV055A	250	85	90	220	235	60	5.4	1	39	M6	42.5	26.5
FTV075A	270	80	135	240	255	60	6.5	1.5	39	M6	40	70.5
FTV100A	270	90	150	240	255	65	6.5	1.5	45	M10	45	64
FTV130A	270	90	150	240	255	65	6.5	1.5	45	M10	45	64
FTV180A	380	120	170	350	365	102	6.5	1.5	49.5	M10	60	47

Dimensions FTV250A

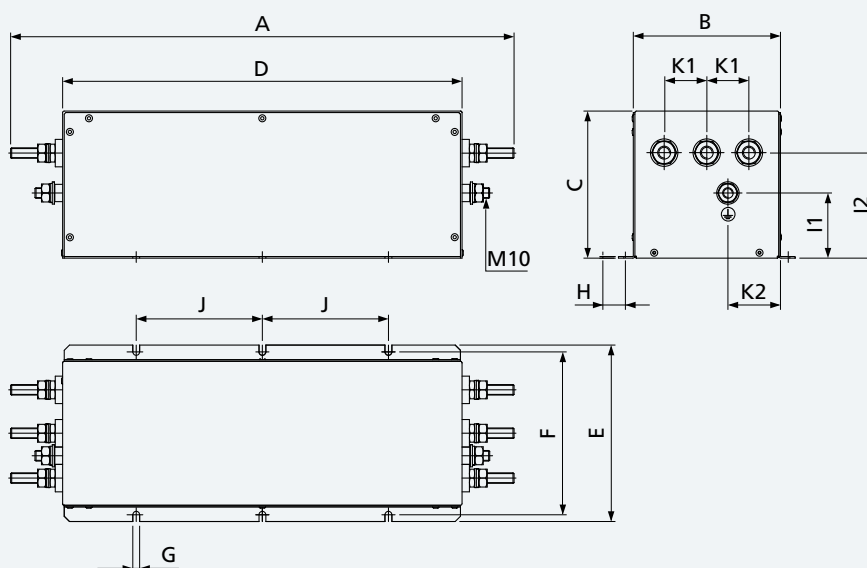

EMI filter	A	B	C	D	E	F	G	H	I1	I2	J	K1	K2
[mm]													
FTV250A	482	140	140	380	168	155	6.5	1.5	62	100	120	40	50

Braking resistors

When speed of an inverter-controlled ac motor is reduced, the motor acts as a generator, feeding back energy to the frequency inverter. As a result, voltage in the intermediate circuit of the inverter increases. When a specific threshold is exceeded, the energy must flow to an external braking system in order to avoid drive failures. Braking resistors are designed to absorb such energy and to dissipate it into heating. The use of brake resistors allows drives to fulfil the requirements of particularly severe duty cycles, for example those featured by frequent braking, long lasting braking or impulsive braking.

Bonfiglioli Vectron offers a wide range of safe and compact braking resistors with IP20 degree of protection: "BR series".

BR series are designed for panel mounting.

Mostly, they are equipped with built-in thermal protection.

BR models have been thoroughly tested with Bonfiglioli frequency inverters, therefore they can be used together with all Active, Synplus, and VCB models.



Connection diagram

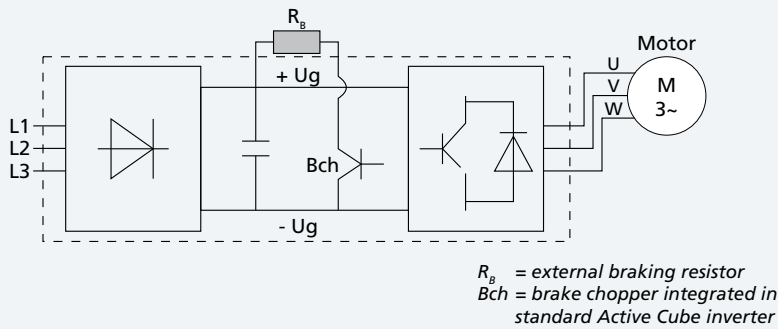

Connection terminals

The R_{b1} and R_{b2} braking resistor terminals on Active Cube frequency inverters are located on the X2 power output terminal strip. Access to these terminals on size 1 and 2 units is made even easier by the use of disconnectable power terminal strips. Refer to the manual provided with your frequency inverter for further details on materials and connection methods.

Frequency inverter
(from 0.25 to 4.0 kW)

X2 terminal strip

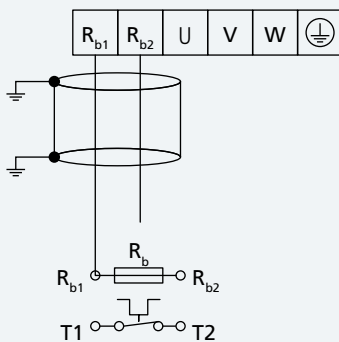

Frequency inverter
(from 5.5 to 132 kW)

X2 terminal strip

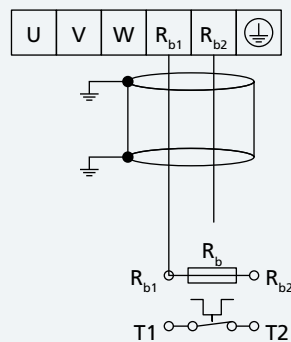

Braking resistors

Active Cube drive combination chart

These charts show recommended combinations for each model in the Active Cube range, and specify the corresponding duty cycles on the basis of rated drive

power. Contact your nearest Bonfiglioli Drive Centre for particularly heavy-duty braking applications or if you need to customise a product.

Active Cube Series	kW	Bonfiglioli braking resistor	Resistance Ohm	Continuous rated power	Duty cycle at the drive's rated power
					[W]
ACU 201-01	0.25	BR 160/100	100	160	64%
ACU 201-03	0.37	BR 160/100	100	160	43%
ACU 201-05	0.55	BR 160/100	100	160	29%
ACU 201-07	0.75	BR 160/100	100	160	21%
ACU 201-09	1.1	BR 160/100	100	160	15%
ACU 201-11	1.5	BR 432/37	37	432	29%
ACU 201-12	2.2	BR 432/37	37	432	20%
ACU 201-15	3	BR 432/37	37	432	14%
ACU 201-18	4	BR 667/24	24	667	17%
ACU 201-19	5.5	BR 667/24	24	667	12%
ACU 201-21	7.5	BR 1333/12	12	1333	18%
ACU 201-22	9.2	BR 1333/12	12	1333	14%
ACU 401-01	0.25	BR 213/300	300	213	85%
ACU 401-03	0.37	BR 213/300	300	213	57%
ACU 401-05	0.55	BR 213/300	300	213	39%
ACU 401-07	0.75	BR 213/300	300	213	28%
ACU 401-09	1.1	BR 213/300	300	213	19%
ACU 401-11	1.5	BR 213/300	300	213	14%
ACU 401-12	1.85	BR 471/136	136	471	25%
ACU 401-13	2.2	BR 471/136	136	471	21%
ACU 401-15	3	BR 471/136	136	471	16%
ACU 401-18	4	BR 696/92	92	696	17%
ACU 401-19	5.5	BR 1330/48	48	1330	24%
ACU 401-21	7.5	BR 1330/48	48	1330	18%
ACU 401-22	9.2	BR 1330/48	48	1330	14%
ACU 401-23	11	BR 2000/32	32	2000	18%
ACU 401-25	15	BR 2000/32	32	2000	13%
ACU 401-27	18.5	BR 4000/16	16	4000	22%
ACU 401-29	22	BR 4000/16	16	4000	18%
ACU 401-31	30	BR 4000/16	16	4000	13%
ACU 401-33	37	BR 8000/7	7.5	8000	22%
ACU 401-35	45	BR 8000/7	7.5	8000	18%
ACU 401-37	55	BR 8000/7	7.5	8000	15%
ACU 401-39	65	BR 8000/7	7.5	8000	12%
ACU 401-43	75	BR8000/7	7.5	8000	11%
ACU 401-45	90	BR8000/7	7.5	8000	9%
ACU 401-47	110	2xBR8000/7	3.75	16000	15%
ACU 401-49	132	2xBR8000/7	3.75	16000	12%

For further information refer to the Bonfiglioli braking resistor catalogue.

Added value



We want to share the value of our work with you.



The development of effective, tailored solutions for a wide range of applications is a fundamental aspect of our work.

We succeed so well because we co-operate closely with our customers, listen to their requests and work with them to improve our own performance.



Bonfiglioli is determined to deliver the best service possible - before, during and after the sale of any of our products - by applying all our know-how, experience, technology and advanced communication tools. Bonfiglioli works to the strictest standards of quality and safety, as certified by seven different internationally recognised institutes.



We believe in innovation, and back up this belief by dedicating 100 of our people and 5 activity centres to research and development and by working hand in hand with some of the world's most prestigious universities.

Our work also brings us into contact with other nations and cultures, for which we have the greatest respect and with whom we share a vision of sustainable development based on renewable energy.

This binding commitment allows us to be an authoritative and reliable global partner for the present and the future.



Branches and facilities

Our branches

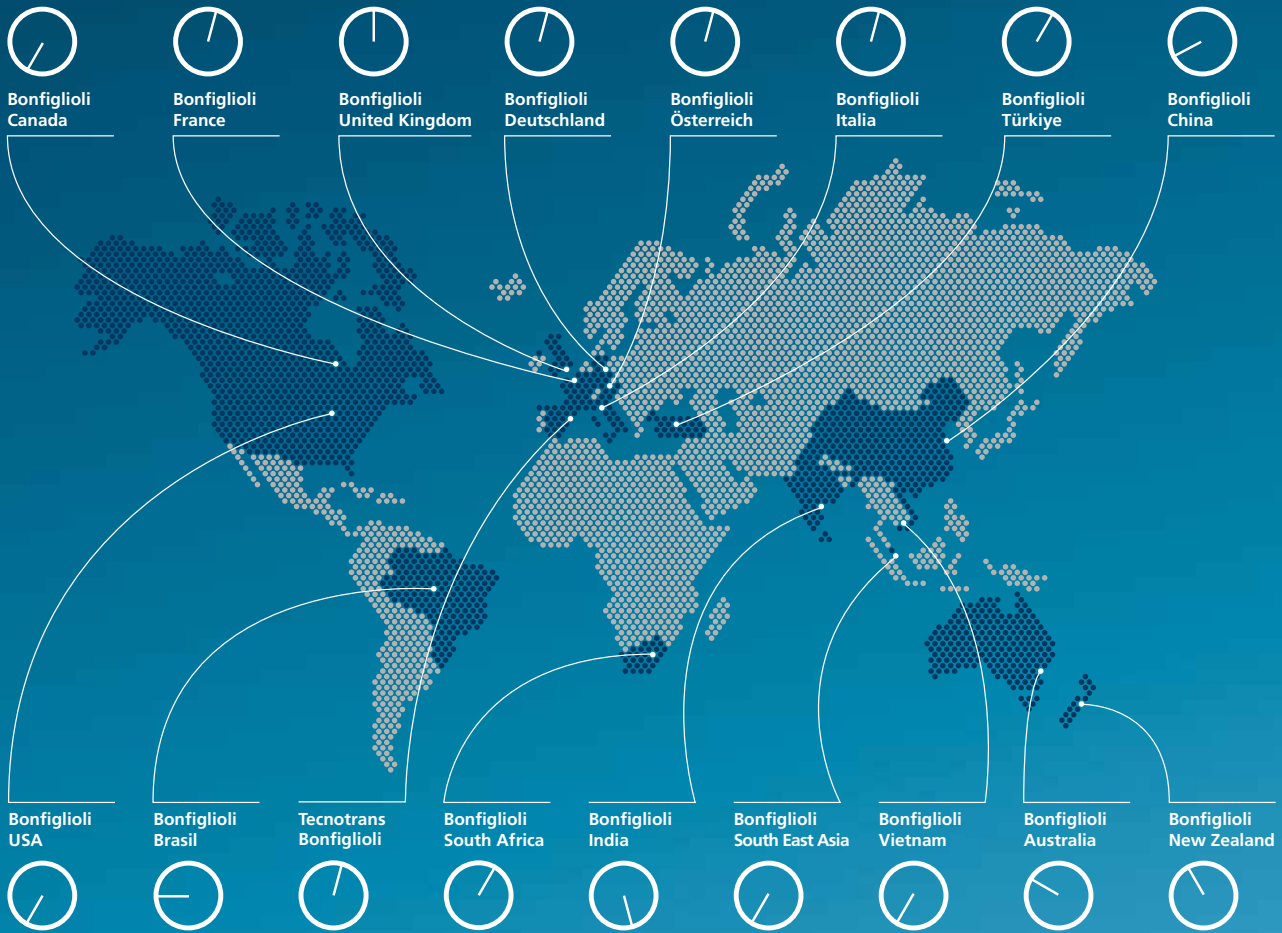

Our production facilities

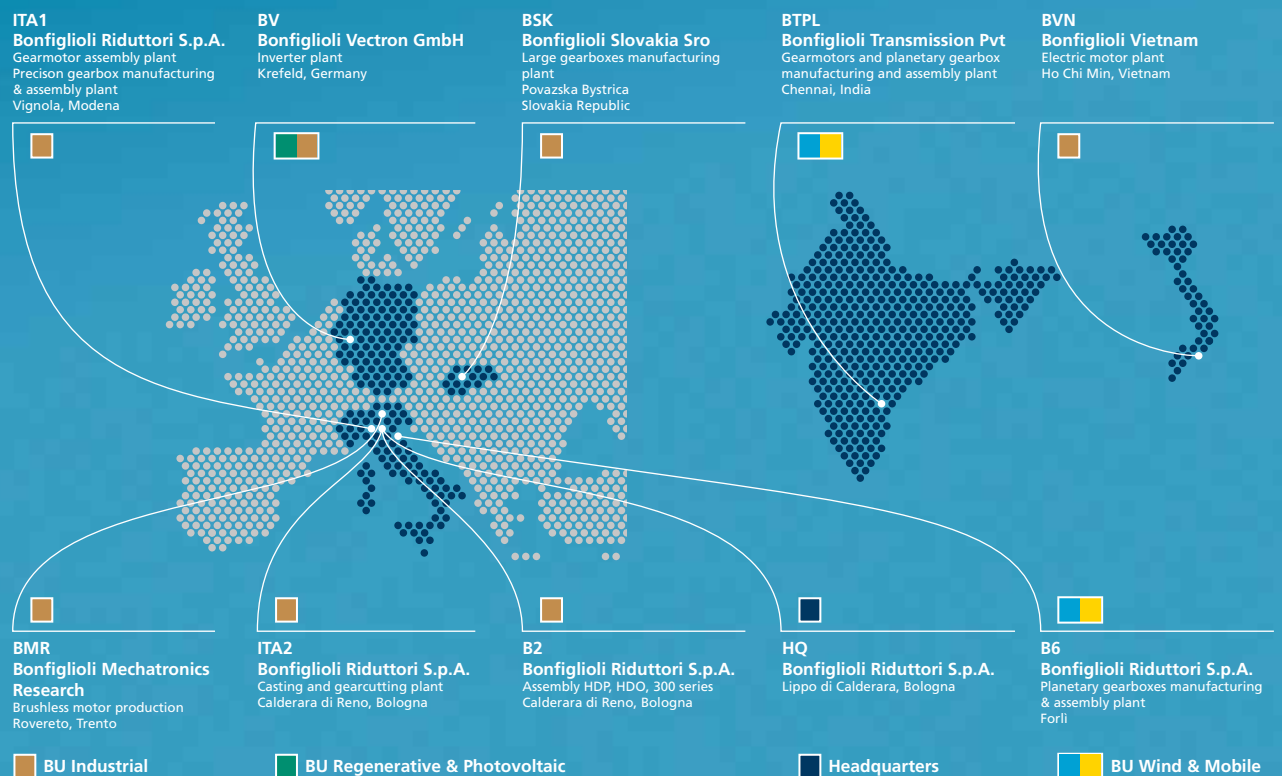

Bonfiglioli is your partner worldwide for power transmission and motion control.

Customer satisfaction has always been one of Bonfiglioli's key values. It is pursued around the world, and in a wide range of contexts, by a network of subsidiaries located in 17 countries and on 5 continents. Each subsidiary provides rapid and efficient pre-sales and after-sales service, and can guarantee prompt deliveries from local assembly plant and warehouses. In addition to our directly controlled subsidiaries, Bonfiglioli can also rely on an extensive network of authorised dealers, selected for their ability to guarantee excellent pre-sales and after-sales assistance. To give everybody the chance to purchase a Bonfiglioli product - anywhere. This is the ambitious objective that drives the

development of our added value sales networks, off and on-line. BEST (Bonfiglioli Excellence Service Team) is one of the most modern sales organisations in the field of power transmission. Our BEST partners can benefit from our local assembly plant and warehouses, our training courses and tools, and our promotional activities. For the first time ever, manufacturer and distributors are working together from the product assembly stage and in the design of new applications, in a sharing process that sees one party transferring know-how and technology and the other partly providing a thorough knowledge of the local market.



Bonfiglioli worldwide network.

Bonfiglioli Australia

2, Cox Place Glendenning NSW 2761
Locked Bag 1000 Plumpton NSW 2761
Tel. (+ 61) 2 8811 8000 - Fax (+ 61) 2 9675 6605
www.bonfiglioli.com.au - sales@bonfiglioli.com.au

Bonfiglioli Brasil

Travessa Cláudio Armando 171
Bloco 3 - CEP 09861-730 - Bairro Assunção
São Bernardo do Campo - São Paulo
Tel. (+55) 11 4344 2323 - Fax (+55) 11 4344 2322
www.bonfigliolidobrasil.com.br
bonfigliolidobrasil@bonfiglioli.com

Bonfiglioli Canada

2-7941 Jane Street - Concord, Ontario L4K 4L6
Tel. (+1) 905 7384466 - Fax (+1) 905 7389833
www.bonfigliolicanada.com
sales@bonfigliolicanada.com

Bonfiglioli China

19D, No. 360 Pu Dong Nan Road
New Shanghai International Tower - 200120 Shanghai
Tel. (+86) 21 5054 3357 - Fax (+86) 6886 2686
www.bonfiglioli.cn - bdsales@bonfiglioli.com

Bonfiglioli Deutschland

Industrial, Mobile, Wind
Sperberweg 12 - 41468 Neuss
Tel. +49 (0) 2131 2988 0 - Fax +49 (0) 2131 2988 100
www.bonfiglioli.de - info@bonfiglioli.de

Industrial, Photovoltaic

Bonfiglioli Vectron 
Europark Fichtenhain B6 - 47807 Krefeld
Tel. +49 (0) 2151 8396 0 - Fax +49 (0) 2151 8396 999
info@vectron.net

Bonfiglioli España

Industrial, Mobile, Wind
Tecnotrans Bonfiglioli S.A.
Pol. Ind. Zona Franca sector C, calle F, n°6
08040 Barcelona
Tel. (+34) 93 4478400 - Fax (+34) 93 3360402
www.tecnotrans.com - tecnotrans@tecnotrans.com

Photovoltaic
Ribera del Loira, 46 - Edificio 2 - 28042 Madrid
Tel. (+34) 91 5030125 - Fax (+34) 91 5030099
pvsain@bonfiglioli.com

Bonfiglioli France

14 Rue Eugène Pottier BP 19
Zone Industrielle de Moimont II - 95670 Marly la Ville
Tel. (+33) 1 34474510 - Fax (+33) 1 34688800
www.bonfiglioli.fr - btf@bonfiglioli.fr

Bonfiglioli India

PLOT AC7-AC11 Sidco Industrial Estate
Thirumudivakkam - Chennai 600 044
Tel. +91(0) 44 24781035 - 24781036 - 24781037
Fax +91(0) 44 24780091 - 24781904
www.bonfiglioliindia.com - bonfig@vsnl.com

Bonfiglioli Italia

Via Sandro Pertini lotto 7b - 20080 Carpiano (Milano)
Tel. (+39) 02 985081 - Fax (+39) 02 985085817
www.bonfiglioli.it - customerservice.italia@bonfiglioli.it

Bonfiglioli New Zealand

88 Hastie Avenue, Mangere Bridge, Auckland
2022, New Zealand - PO Box 11795, Ellerslie
Tel. (+64) 09 634 6441 - Fax (+64) 09 634 6445
npollington@bonfiglioli.com.au

Bonfiglioli Österreich

Molkereistr 4 - A-2700 Wiener Neustadt
Tel. (+43) 02622 22400 - Fax (+43) 02622 22386
www.bonfiglioli.at
info@bonfiglioli.at

Bonfiglioli South East Asia

24 Pioneer Crescent #02-08
West Park Bizcentral
Singapore, 628557
Tel. (+65) 6268 9869 - Fax. (+65) 6268 9179
www.bonfiglioli.com
sales@bonfiglioli.com.sg

Bonfiglioli South Africa

55 Galaxy Avenue,
Linbro Business Park - Sandton
Tel. (+27) 11 608 2030 OR - Fax (+27) 11 608 2631
www.bonfiglioli.co.za
bonfigsales@bonfiglioli.co.za

Bonfiglioli Türkiye

Atatürk Organize Sanayi Bölgesi,
10044 Sk. No. 9, 35620 Çiğli - Izmir
Tel. +90 (0) 232 328 22 77 (pbx)
Fax +90 (0) 232 328 04 14
www.bonfiglioli.com.tr
info@bonfiglioli.com.tr

Bonfiglioli United Kingdom

Industrial, Photovoltaic
Unit 7, Colemeadow Road
North Moons Moat - Redditch,
Worcestershire B98 9PB
Tel. (+44) 1527 65022 - Fax (+44) 1527 61995
www.bonfiglioli.com
uksales@bonfiglioli.com

Mobile, Wind
3 - 7 Grosvenor Grange, Woolston
Warrington - Cheshire WA1 4SF
Tel. (+44) 1925 852667 - Fax (+44) 1925 852668
www.bonfiglioli.co.uk
salesmobile@bonfiglioli.com

Bonfiglioli USA

3541 Hargrave Drive Hebron, Kentucky 41048
Tel. (+1) 859 334 3333 - Fax (+1) 859 334 8888
www.bonfiglioliusa.com

Bonfiglioli Vietnam

Lot C-9D-CN My Phuoc Industrial Park 3
Ben Cat - Binh Duong Province
Tel. (+84) 650 3577411 - Fax (+84) 650 3577422
www.bonfiglioli.vn
salesvn@bonfiglioli.com



Bonfiglioli has been designing and developing innovative and reliable power transmission and control solutions for industry, mobile machinery and renewable energy applications since 1956.