



MOTION & ROBOTICS *Solutions*

PRODUCT RANGE

 **Bonfiglioli**

MOTION & ROBOTICS



Frequency inverters

AxiaVert Series
ANG Series
Active Cube Series
Agile Series
S2U Series
S2U IP66 Series

Regenerative Units

AEC Series

Permanent Magnet Synchronous & Synchronous Reluctance Motors

BMD Series
BSR Series

Precision Planetary Gearboxes

Performance line

TQ Series
TQK Series
TQF Series
TR Series
MP Series

Effective line

TQFE Series
TQFEK Series
SL Series
LC Series
LCK Series
MPE Series
MPEK Series
KR Series

Industrial gearmotors

A Series
C Series
F Series
VF/W Series
300 Series

Integrated devices

BMS Series

Gearmotors for AGVs and AMRs

BlueRoll Basic
BlueRoll Advanced
BlueRoll Compact



CO-ENGINEERING
DEVELOPMENT



PROJECT
COMMISSIONING



SERVICES



DIGITAL
TOOLS

The highest level of precision, efficiency and energy optimization.

With almost 20 years of experience in creating dedicated motion control systems, Bonfiglioli has gained a solid reputation as one-stop shop for mechatronic applications in industrial automation.

Bonfiglioli engineering specialists work side by side with customers to develop tailored and forward-thinking integrated solutions, covering the entire motion drive train according to an Industry 4.0 approach.

Thanks to the extensive know-how and the long-term collaboration with key customers, our two centers of excellence, located in Italy and Germany, develop breakthrough mechatronic innovations, including low backlash planetary gearboxes, servomotors, open and closed loop inverters, servo inverters and regenerative inverters.

This, combined with a comprehensive range of Professional Services, enables us to respond to customers' requests with targeted solutions aimed at achieving:

- High efficiency
- High productivity
- Agility
- Easy-to-use drive solutions
- Always up-to-date data for diagnostic, maintenance and predictive analytics
- Low operating costs

Bonfiglioli also provides solutions for:



DISCRETE MANUFACTURING
& PROCESS INDUSTRIES



ELECTROMOBILITY



MOBILE



WIND

www.bonfiglioli.com



MECHATRONIC SOLUTIONS FOR ALL INDUSTRIAL APPLICATIONS

Our engineering specialists work side by side with customers to create the best possible solution, whether the request is to optimize an existing machine or to develop a new one. Our relationship with customers is based on an active partnership with fast decision-making processes to develop individually-tailored offers.

Our full-range offering provides the necessary products for the development of vertically integrated solutions in a variety of applications, such as material handling, automated storage, textile and packaging. Our team of experts assists customers in designing cost effective and energy efficient machines, aligning performance to meet the specific requirements.



A complete integrated solution

- Precision Planetary Gearboxes
- Industrial Gearboxes
- PM Synchronous Motors
- Synchronous Reluctance Motors
- Asynchronous motors
- Servo Inverters
- Frequency Inverters
- Energy Regenerative Inverters
- Motion Control
- Industry 4.0 solutions

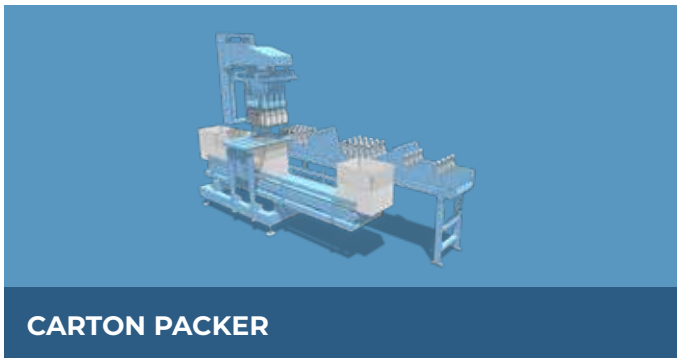

CARTON PACKER

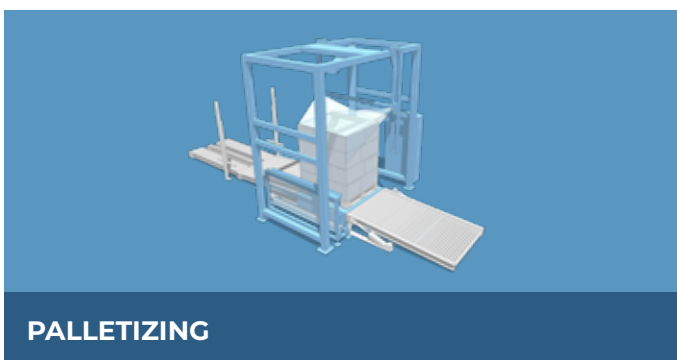

PALLETIZING



AUTOMATIC STORAGE



Our services

▪ APPLICATION / ENGINEERING

Assessment and Orientation
 Engineering and Planning
 Retrofit and Modernization

▪ INSTALLATION / START-UP

On-site assistance
 Start-up assistance
 Commissioning

▪ AFTER SALES

Maintenance
 Pre- and post-sale customer service
 Training

Industry sector expertise



MATERIAL HANDLING



HOIST & CRANES



FOOD & BEVERAGE



AUTOMATED WAREHOUSE



PACKAGING



TEXTILES



MATERIAL WORKING

BONFIGLIOLI DIGITAL TOOLS



EPLAN

Enhance your electrical design

Intense competition is putting pressure on machine builders and system integrators to deliver machines with higher throughput and reduced operating cost in shorter timeframes, leading to a significant increase in the **complexity of the machine design** process.



DOCUMENTS

DE
EN
ES

MULTILINGUAL
SUPPORT



COMMERCIAL
DATA



LOGIC
DATA



2D/3D
DATA



PRODUCTION
DATA

System design challenge

Bonfiglioli and EPLAN work together to provide efficient engineering solutions, aimed at reducing the gap between the initial concept and its development, programming and commissioning.

- **Better quality of documentation:** the EPLAN Data Portal provides users with up-to-date device data from numerous component manufacturers, saving time for manual data collection and minimizing the risks of faulty data.
- **Shorter system design times:** by including macro-information, function templates, production data and drawings, EPLAN allows users to drag and drop Bonfiglioli drawing templates into their own electrical drawings, reducing the time needed for cabinet planning.

Bonfiglioli products available on EPLAN data portal



Active Next
Generation Series



Active Cube
Series



Agile Series



SERVOsoft

Develop optimized solutions

Bonfiglioli and SERVOsoft® work together to support customers in sizing complete **multi-axis servo systems**, including motors, gearboxes and servodrives with **15 mechanisms** and up to **50 axes** in a shared bus or standalone configuration.



With Bonfiglioli offering available on SERVOsoft, customers are able to select, size and design their customized and high performance applications. In addition, Bonfiglioli engineering team - thanks to its in-depth knowledge of the products - uses the high level servosizing tool SERVOsoft® to provide a top level customer support service by developing **optimized, energy-efficient and tailored** engineering solutions to meet individual needs.

Benefits

- High level of optimization
- Unique supplier and tailored-made solutions
- Energy-saving solutions
- Tuning of the project in real conditions and further optimization
- Powerful servosizing tool for both customers and Bonfiglioli team

Frequency inverters



HIGH PERFORMANCE FREQUENCY INVERTER



AxiaVert Series

Bonfiglioli AxiaVert (AXV) series is designed to allow great flexibility and top-level performance, making it suitable for a wide range of applications. Thanks to its modular system, the AxiaVert series offers integrated Functional Safety, optional encoder evaluation and open communication protocols complying with Industry 4.0 standards and an intuitive GUI for commissioning and monitoring.

Whether in material working, logistics, automated storage, packaging or textile the frequency inverters of the AxiaVert series are optimized for numerous applications.

The AxiaVert series offers integrated Functional Safety, organized into different variants, which can be selected to best suit the application's requirements, optimizing price and performance to match the machine functions.

Power supply & Power range

- 3 phase 400V mains: 0.25 - 15 kW
- 3 phase 230V mains: 0.25 - 9.2 kW
- 1 phase 230V mains: 0.25 - 3 kW

Motor control

(open loop or optional closed loop):

- Asynchronous AC motors
- Synchronous Reluctance motors
- Permanent magnet synchronous (brushless) motors

Mounting options

- Cabinet mounting for all sizes
- Optional feed-through mounting
- Optional DIN rail mounting
- Optional ColdPlate
- Vibration resilient mounting kit for Air Cooling devices

Overload capacity

- up to 150 % overload for 60 s
- up to 300 % overload for 2 s

Functional Safety Variants

- STO, SBC (SIL 3 / PL e)
- STO, SBC, SS1 (SIL 3 / PL e)
- STO, SBC, SS1, SS2, SLS*, SSM*, SDI*, SLP*, SOS* (SIL3 / PL e)

* Without encoder: SIL 2 / PL d

Key features

- Support for FSoE and Functional Safety encoders
- IIoT ready
- CiA402 Motion Control
- Electronic gear function
- Functions for lift, crane and winch applications
- Power failure management
- Motor supervision functions (Temperature, I_t, Software Motor switch, Encoder supervision,...)
- Position, Speed or Torque Control
- Programmable S curve
- 4 data sets
- PID controller
- Jerkfree torque/speed changeover
- DC link connection
- Standard HTL encoder interface
- Integrated brake chopper
- Brake control output (DC 24 V / 3 A)
- Plug-in power terminals (up to 15 kW)
- Plug-in and programmable control terminals
- 5 digital inputs, 1 digital input/output, 1 multifunction input, 1 analogue output, 1 analogue input, 1 relay output (changeover contact)
- DC 24 V input (double pin connector for easy wiring)
- DC 24 V output
- Jumper to switch easily between TN mains and IT mains (up to 15 kW)

- Drive commissioning, diagnosis and tuning with user friendly options including Keypad, PC connection, Mobile App

Options

- Different Fieldbus options, such as CANopen, EtherCAT, PROFINET, PROFIBUS
- Encoder support with Expansion modules: TTL, Resolver, SinCos, Hiperface, Hiperface DSL, EnDat 2.1, EnDat 2.2, SSI
- Commissioning and Diagnosis via optional graphical keypad
- Optional Remote Access Module for the connection to a PC or a mobile phone via Bluetooth
- Accessories like brake resistor, line chokes and EMC filters available

Enclosure

- IP20 (EN 60529)



HIGH PERFORMANCE FREQUENCY INVERTER



ANG Series

Active Next Generation (ANG) is a motion control application inverter that can be used in servo applications and as frequency inverter. The ANG Series offers a wide power range from 0.25 kW to 400 kW (with parallel connection of drives up to 1200 kW). It can control asynchronous and synchronous motors in open and closed loop operations. Field bus communication and encoder evaluation is always on board, making the Active Next Generation Series the perfect drive for motion control applications in closed loop control like packaging, textile machines, food & beverage, warehouse and material handling. For integration in functional safety environments, ANG offers STO functionality according to SIL 3 and PL e.

Power supply & Power range

- ANG210: 0.25 - 9.2 kW / single or three-phase 200 - 240V / 50 - 60 Hz ($\pm 10\%$)
- ANG410: 0.25 - 400 kW / three-phase 360 - 480V / 50 - 60 Hz ($\pm 10\%$)
Parallel connection up to 1200 kW
- ANG510: 160 - 400 kW / three-phase 525V / 50 - 60 Hz ($\pm 10\%$)
Parallel connection up to 1200 kW
- ANG610: 160 - 400 kW / three-phase 690V / 50 - 60 Hz ($\pm 10\%$)
Parallel connection up to 1200 kW

Motor control

- (open loop or optional closed loop):
- Asynchronous AC motors
 - Permanent magnet synchronous (brushless) motors

Mounting options

- Cabinet mounting for all sizes
- Optional feed-through mounting
- Optional DIN rail mounting frame size 1
- Optional ColdPlate (sizes 1 to 5)
- Optional liquid cooling (sizes 5 to 8)

Overload capacity

- up to 150% for 60 seconds
- up to 200% for 1 second

Key features

- Different variants include field bus connection and encoder evaluation
- Plug-in power terminals (up to 3kW)
- Plug-in and programmable control terminals
- DC link connection
- Integrated brake chopper
- Positioning function via field bus (Motion control compatible with CiA 402)
- Cubic interpolation
- Integrated VPLC
- Master/slave function with electronic gear
- Power failure control
- Integrated safe torque off STO (SIL 3 / PL e) function
- Output frequency 0...599 Hz, higher frequencies on request
- Diagnosis and setup via optional keypad or PC software

Variants

Variants automation interface:

- EM-AUT-01: EtherCAT® and Encoder evaluation (TTL, HTL, Resolver, Hiperface, EnDat 2.1)
- EM-AUT-04: EtherCAT®
- EM-AUT-11: PROFINET and Encoder evaluation (TTL, HTL, Resolver, Hiperface, EnDat 2.1)
- EM-AUT-21: Ethernet/IP and Encoder evaluation (TTL, HTL, Resolver, Hiperface, EnDat 2.1)
- EM-AUT-31: Varan and Encoder evaluation (TTL, HTL, Resolver, Hiperface, EnDat 2.1)

Options

- Optional keypad for diagnosis and parameter setup
- Optional PC interface
- Optional accessories like brake resistor, mains chokes, mains filters

Enclosure

- IP20 (EN 60529)

HIGH PERFORMANCE FREQUENCY INVERTER



Active Cube Series

Active Cube (ACU) is the high performance frequency inverter with a wide power range from 0.25 kW to 400 kW (with parallel drive connection up to 1200 kW). It can control asynchronous, synchronous and synchronous reluctance motors in open and closed loop operations. Several optional modules for communication and expansions for I/O control and encoder evaluation make the premium frequency inverter ideal for a wide range of high performance applications, such as warehouse and material handling, automatic storage systems, textile machines, packaging, food & beverage, motion control and hoists and cranes applications. For integration in functional safety environments, ACU offers STO functionality according to SIL 3 and PL e.

Power supply & Power range

- ACU210: 0.25 - 9.2 kW / single or three-phase 200 - 240V / 50 - 60 Hz ($\pm 10\%$)
- ACU410: 0.25 - 400 kW / three-phase 360 - 480V / 50 - 60 Hz ($\pm 10\%$)
Parallel connection up to 1200 kW
- ACU510: 160 - 400 kW / three-phase 525V / 50 - 60 Hz ($\pm 10\%$)
Parallel connection up to 1200 kW
- ACU610: 160 - 400 kW / three-phase 690V / 50 - 60 Hz ($\pm 10\%$)
Parallel connection up to 1200 kW

Motor control

(open loop or optional closed loop):

- Asynchronous AC motors
- Synchronous Reluctance motors
- Permanent magnet synchronous (brushless) motors

Mounting options

- Cabinet mounting for all sizes
- Optional feed-through mounting
- Optional DIN rail mounting frame size 1
- Optional ColdPlate (sizes 1 to 5)
- Optional liquid cooling (sizes 5 to 8)

Overload capacity

- up to 150% for 60 seconds
- up to 200% for 1 second

Key features

- Optionally expanding series for field bus communication and encoder evaluation
- Plug-in power terminals (up to 3kW)
- Plug-in and programmable control terminals
- DC link connection
- Integrated brake chopper
- Positioning function via field bus (Motion control compatible with CiA 402)
- Integrated VPLC
- Master/slave function with electronic gear
- Power failure control
- Integrated safe torque off STO (SIL 3 / PL e) function
- Output frequency 0...599 Hz, higher frequencies on request
- Diagnosis and setup via optional keypad or PC software

Options

- Different field bus options, such as CANopen, PROFIBUS, Modbus, EtherCAT, PROFINET, Varan
- Optional I/O extensions for additional digital and analogue inputs & outputs
- Optional keypad for diagnostics and parameter setup
- Optional PC interface
- Optional accessories like brake resistor, mains chokes, mains filters

Enclosure

- IP20 (EN 60529)

STANDARD FREQUENCY INVERTER



Agile Series

The Agile (AGL) Series is a flexible compromise for standard applications, such as warehouse and material handling (for example glass, wood, marble), textile machines, food & beverage, packaging, ceramic and hoists applications. The Agile Frequency Inverter Series has three mechanical sizes for power ranges between 0.12 and 11 kW, with open loop control for asynchronous and synchronous motors. For integration into functional safety environments, AGL offers STO functionality according to SIL 2 and PL d.

Power supply & Power range

- AGL202: 0.12 - 3 kW / single-phase 200 V... 240 V / 50 - 60 Hz ($\pm 10\%$)
- 0.25 - 7.5 kW / three-phase 200 V ... 240 V / 50 - 60 Hz ($\pm 10\%$)
- AGL402: 0.25 - 11 kW / three-phase 320 V... 530 V / 50 - 60 Hz ($\pm 10\%$)

Motor control

(open loop):

- Asynchronous AC motors
- Permanent magnet synchronous (brushless) motors

Mounting options

- Cabinet mounting for all sizes
- Optional feed-through mounting
- Optional DIN rail mounting frame size 1
- Optional ColdPlate

Overload capacity

- up to 150% for 60 seconds
- up to 200% for 1 second

Key features

- Optionally expanding series for field bus communication
- Sensorless control of synchronous and asynchronous motors
- Modbus and Systembus onboard
- DC link connection
- Integrated brake chopper
- Power failure control
- Programmable PI controller
- Integrated VPLC
- Master/slave function with electronic gear
- Integrated safe torque off STO (SIL 2 / PL d) function
- Energy saving function
- Intelligent current limits
- Output frequency 0...599 Hz, higher frequencies on request
- Diagnostics and setup via integrated keypad and integrated service interface for PC connection

Options

- Different field bus options, such as CANopen, PROFIBUS, Modbus
- Optional accessories like brake resistor, mains chokes, mains filters
- Optional PC connection set

Enclosure

- IP20 (EN 60529)

BASIC FREQUENCY INVERTER



S2U Series

Our S2U frequency inverters are designed for simple handling applications and are quickly integrated into your machines. The S2U frequency inverter is available in two mechanical sizes ranging from 0.20 kW to 2.2 kW for 230 V single phase operations. S2U is already preset for corresponding open loop controlled asynchronous motors. You can also adjust the basic behavior of the drive with a set of 30 parameters. S2U is our solution for compact and economic applications, such as pumps, fans and material handling including packaging and textile machines.

Power supply & Power range

- S2U230S: 0.2 - 2.2 kW / single-phase 200 - 240V (+10%-15%) / 50 or 60 Hz

Motor control

(open loop):

- Asynchronous AC motors

Mounting options

- Cabinet mounting for all sizes
- Optional DIN rail mounting frame size 1 & 2

Overload capacity

- up to 150% for 60 seconds

Key features

- Sensorless control of asynchronous motors
- Modbus onboard
- Reference speed via analogue inputs or integrated potentiometer
- Small amount of parameters for simple setup or optional advanced and more flexible parameter setup
- Power failure control
- Output frequency 0...650 Hz
- Diagnostics and setup via integrated keypad and integrated service interface for PC connection

Options

- Optional accessories, such as mains chokes, mains filters
- Optional PC connection set

Enclosure

- IP20 (EN 60529)

BASIC FREQUENCY INVERTER IP66



S2U IP66 Series

The S2U IP66 frequency inverter series is available in three mechanical sizes, ranging from 0.40 kW to 18.5 kW. S2U is already preset for corresponding open loop controlled asynchronous motors. S2U IP66 is our compact, robust and economic solution for applications operating in harsh environments, such as pumps, fans and conveyor belts. S2U IP66 frequency inverter, with a simple change of the advanced parameter settings, is also suitable for packaging, textile, material processing, woodworking and food & beverage applications. The heat sink function is specifically designed for extreme environmental conditions such as dust, humidity, and cleaning chemicals.

Power supply & Power range

- S2U230T-..(F) IP66: 0.4 - 2.2 kW / single-phase 200 - 240V (+10%-15%) / 50 or 60 Hz
- S2U400T-..F IP66: 0.75 - 18.5 kW / three-phase 380 - 480V (+10%-15%) / 50 or 60 Hz

Motor control

(open loop):

- Asynchronous AC motors

Mounting options

- Cabinet or field mounting for all sizes

Overload capacity

- up to 150% for 60 seconds

Key features

- Solution for harsh environments
- Sensorless control of asynchronous motors
- Integrated brake chopper
- Fire override mode selectable via parameter setup
- Reference speed via analogue inputs or integrated potentiometer
- Modbus onboard
- Small amount of parameters for simple setup or optional advanced and more flexible parameter setup
- Integrated PLC function with Ladder programming
- Output frequency 0...599 Hz
- Diagnostics and setup via integrated keypad and integrated service interface for PC connection

Options

- Optional accessories, such as brake resistor, mains chokes, mains filters
- Optional PC connection set

Enclosure

- IP66 (EN 60529)

REGENERATIVE UNITS

REGENERATIVE DRIVE



AEC Series

Decades of experience in electronic industrial drives and renewable energy have enabled Bonfiglioli to offer an effective solution for recovering braking energy. This solution comes as the new Active Regenerative System inverters (AEC). In a large number of electrically controlled industrial applications, inertia in moving mechanisms can drive electric motors acting as brakes. They convert kinetic energy into electrical energy. In regenerative processes, this energy is returned to the grid.

Power range

- 9.7 ... 173.2 kVA
- 3-phase 320V ... 440V
- 45Hz ... 66Hz

Overload capacity

- 150% for 1 min

Enclosure

- IP20 (EN 60529)

Main hardware features

- DC link connection
- Adjustable input and regenerative power control
- Short-circuit and earth-fault resistance
- Configurable control terminals

Bus communication

- RS232, RS485, Profibus-DP, CANopen

Operating panel

- Removable KP500 keypad

PC software

- VPlus for Windows operating systems

Software features

- Adjustable displacement factor (sinusoidal)
- Harmonic distortion factor <3% (sinusoidal)
- Adjustable DC link voltage (sinusoidal)
- Power factor ~0.9 (square wave)
- Automatic network synchronization
- Operation independent of phase sequence
- Performance and load characteristics curve

Hardware features

- Integrated dynamic braking module
- DC link connection
- Plug-in and programmable control terminals
- 6 digital inputs, 1 multifunction input
- 1 digital output, 1 multifunction output, 1 relay output (changeover contact)

Key features

- Input and regenerative power with sinusoidal current
- Regenerative power with square-wave current

PERMANENT MAGNET SYNCHRONOUS & SYNCHRONOUS RELUCTANCE MOTORS

SYNCHRONOUS SERVOMOTOR

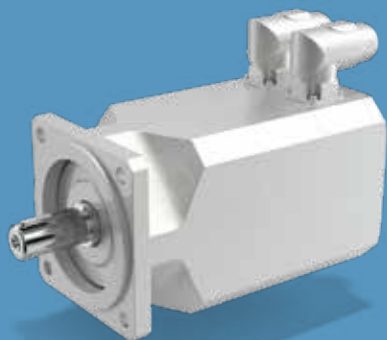

BMD Series

BMD servomotors are permanent magnet synchronous motors with highly compact dimensions and low inertia. They meet the most stringent demands for precision, dynamics and speed settings thanks to their high-quality neodymium iron boron rare-earth magnets and our excellent design. The motors are equipped with the latest encoder technology and are optimized for operation with frequency inverters and precision planetary gearboxes, offering an excellent synergy. More modularity is given by the many available options.

Power supply

- 230, 400 Vac

Rated speed

- 1600, 3000, 4500, 5500, 6000 rpm

Feedback

- 2-pole resolver 8kHz & 10 kHz
- Optical absolute single & multi turn EnDat encoder
- Optical single & multi-turn Hiperface encoder
- Capacitive absolute single and multi-turn Hiperface encoder

Temperature sensor

- PTC
- KTY 84-130
- PT1000

Degree of protection

- IP65
- IP67 (optional)

Inertia

- 0.2 ... 47 (kgm² x 10⁻⁴)

Holding brake (optional)

- 24 Vdc

Additional flywheel (optional)

- 0.5 ... 70 (Kgm² x 10⁻⁴)

Forced ventilation (optional)

- 24 Vdc
- 230 Vac

Torque (Nm)

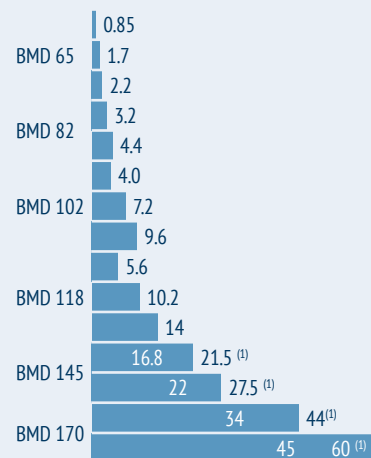

(1) Motor with forced ventilation option

SYNCHRONOUS RELUCTANCE MOTORS

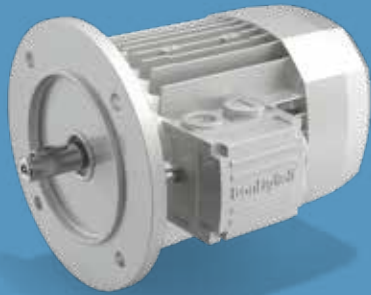

BSR Series

The synchronous reluctance motor guarantees a sustainable energy-saving solution that decreases the overall environmental impact, thanks to the absence of magnets and increased efficiency. Reduced operating costs allow a fast return on investment. This product benefits from the proven simplicity and reliability of induction motors and the higher efficiency of synchronous motors.

Sizes

- High efficiency package
71C ... 132 MB
- High output package
71C ... 132 MA

Rated motor power

- High efficiency package
0.37 ... 9.2 kW
- High output package
0.55 ... 18.5 kW

Power supply

- 400 Vac

Degree of protection

- Standard IP55
- IP56 (optional)

Motor mounting

- B3; B5; B14

Thermal protection

- Silicon sensor KTY 84-130
- Thermistor PTC 150
- Platinum sensor PT1000

Main options

- Anti-condensate heaters power supply 1~230V
- Double extended shaft
- External mechanical protection
- Rotor balancing grade B

Forced ventilation

- Power supply 1 ~ 230 V (for sizes 71 to 100)
- Power supply 3 ~ 400 V (for sizes 112 to 132)

Key benefits

- Highly accurate sensorless control technology
- Compact, economical & eco-friendly
- High dynamic response
- Energy savings
- High reliability
- High performance solution

Both Bonfiglioli packages are IES2 according to the International Efficiency of Systems (IES) classification for the drive-motor combination (IEC 61800-9-2).

PRECISION PLANETARY GEARBOXES

(P) Performance line

(E) Effective line

PRECISION PLANETARY INLINE GEARBOXES



TQ Series

The TQ series scores in each performance category: high torque density, high overload capacity, exceptional precision and low vibration. TQ is particularly suited for the highly demanding requirements of servo systems, such as fast dynamics and frequent reverse motion, precise position, motion control and high numbers of starts and stops.

Main benefits

- Maximum power density
- High precision
- High overload capacity
- Optional reinforced bearings for high axial and radial forces
- Best choice for servo applications requiring high dynamics and high level of precision
- Great flexibility thanks to universal design
- Quiet operation

Main features

- Nominal output torque (Nm)

20 - 800

- Torsional backlash (arcmin)

2 - 6

- Torsional stiffness (Nm/arcmin)

4.7 - 170

- Max tilting moment (Nm)

129.5 - 2331

Protection class

- IP65

Frame sizes

- 060
- 070
- 090
- 130
- 160

Main options

- Input versions

MOTOR ADAPTER	WITHOUT MOTOR ADAPTER
---------------	-----------------------
- Output shafts versions

SMOOTH KEYLESS SHAFT	KEYED SHAFT
----------------------	-------------
- Service type

S1	S5
----	----
- Lubrication

STANDARD LUBRICATION	UH1 FOOD GRADE LUBRICATION
----------------------	----------------------------
- Bearings versions

STANDARD	REINFORCED
----------	------------

PRECISION PLANETARY RIGHT ANGLE GEARBOXES

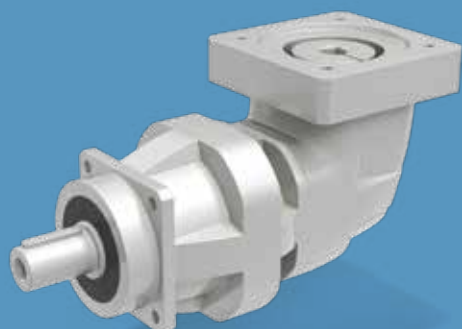

TQK Series

The TQK right-angle series represents the ideal solution for issues of space saving, while maintaining the same top performance levels of the TQ inline series.

This series is particularly suited for the highly demanding requirements of servo systems, such as fast dynamic response, frequent reverse motion, precise position, motion control and high number of starts and stops.

Main benefits

- Highest installation flexibility
- Optional reinforced bearings for high axial and radial overload forces
- Quiet operation
- Compact design for space-saving layouts
- Great flexibility thanks to universal design

Main features

- Nominal output torque (Nm)

20 - 800

- Torsional backlash (arcmin)

4 - 8

- Torsional stiffness (Nm/arcmin)

4.3 - 167

- Max tilting moment (Nm)

129.5 - 2331

Protection class

- IP65

Frame sizes

- 060
- 070
- 090
- 130
- 160

Main options

- Input versions

MOTOR ADAPTER	WITHOUT MOTOR ADAPTER
---------------	-----------------------
- Output shafts versions

SMOOTH KEYLESS SHAFT	KEYED SHAFT
----------------------	-------------
- Service type

S1	S5
----	----
- Lubrication

STANDARD LUBRICATION	UH1 FOOD GRADE LUBRICATION
----------------------	----------------------------
- Bearings versions

STANDARD	REINFORCED
----------	------------

PRECISION PLANETARY ONLINE GEARBOXES

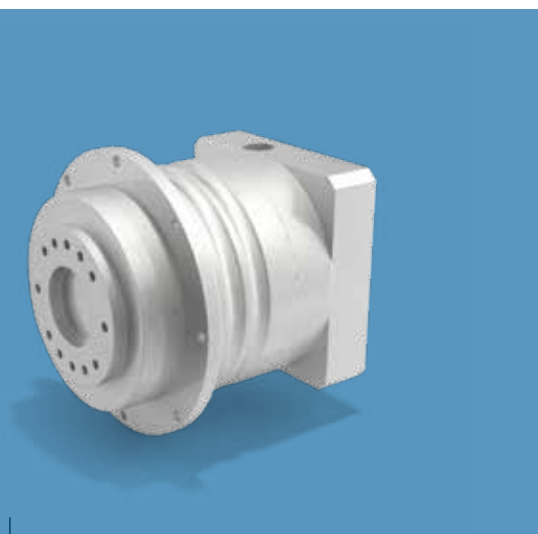

TQF Series

The TQF series features a standardized and exceptionally compact flange interface for easy installations. High tilting moment, high stiffness and overload capacity characterize this robust gearbox within its product category.

Main benefits

- High positioning accuracy
- High compactness
- Easy installation thanks to standardized flange design
- Highest overload capacity
- Great flexibility thanks to universal design

Main features

- Nominal output torque (Nm)
20 - 800
- Torsional backlash (arcmin)
3 - 7
- Torsional stiffness (Nm/arcmin)
12 - 500
- Max tilting moment (Nm)
115 - 3700

Protection class

- IP65

Frame sizes

- 060
- 070
- 090
- 130
- 160

Main options

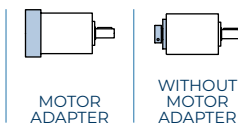
- Input versions

MOTOR ADAPTER WITHOUT MOTOR ADAPTER
- Service type

S1 S5
- Lubrication

STANDARD LUBRICATION FOOD GRADE LUBRICATION

PRECISION PLANETARY IN-LINE & RIGHT ANGLE GEARBOXES

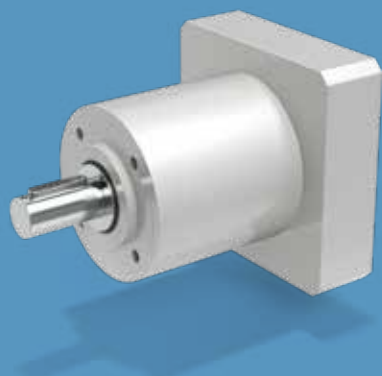

TR Series

In addition to optimal performance, very low backlash, high overload capacity and easy installation, the TR series is characterized by great modularity due to multiple design configurations and wide ratios range, ensuring high reliability and the most fitting response to different applications requirements.

Other design versions

- K/G version



- MB version



Main benefits

- Very low backlash
- Great flexibility thanks to a wide range of gear ratios and multiple design configurations
- Great variety of input and output configurations

Main features

- Nominal output torque (Nm)



- Torsional backlash (arcmin)

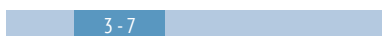

- Torsional stiffness (Nm/arcmin)



- Max tilting moment (Nm)



Protection class

- IP65

Frame sizes

- 053
- 060
- 080
- 105
- 130
- 160
- 190

Main options

- Design versions

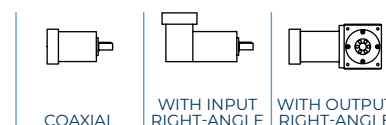

- Input versions

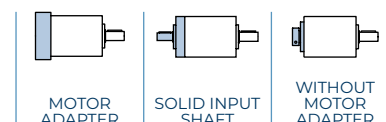

- Output shafts versions

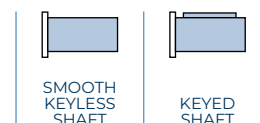

- Service type



- Lubrication



- Bearings versions



PRECISION PLANETARY IN-LINE & RIGHT ANGLE GEARBOXES

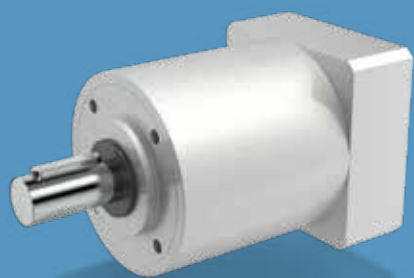

MP Series

The MP series is characterized by a wide range of torque and multiple sizes, great modularity due to multiple design configurations a wide ratios range and different optimized lubrications ensuring high reliability and the most fitting response to different applications requirements.

Other design versions

- K/G version



- MB version



Main benefits

- Wide torque range
- High overload capacity
- Great flexibility thanks to a wide range of gear ratios and multiple design configurations

Main features

- Nominal output torque (Nm)



- Torsional backlash (arcmin)

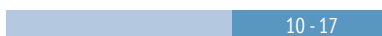

- Torsional stiffness (Nm/arcmin)



- Max tilting moment (Nm)



Protection class

- IP65

Frame sizes

- 053
- 060
- 080
- 105
- 130
- 160
- 190

Main options

- Design versions

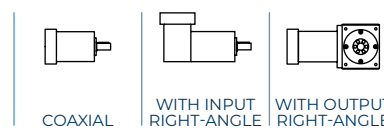

- Input versions

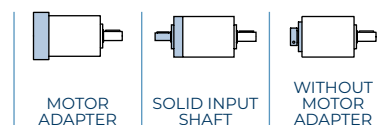

- Output shafts versions

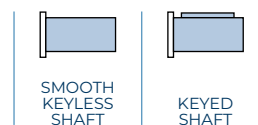

- Service type



- Lubrication



- Bearings versions





PRECISION PLANETARY INLINE GEARBOXES

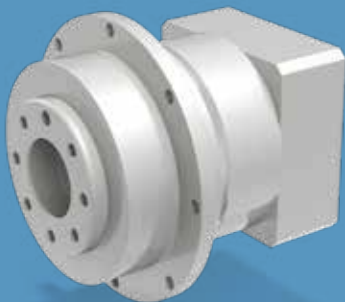

TQFE Series

The TQFE series combines exceptional compactness with a standardized flange interface, ensuring a quick and easy mounting suitable for a wide variety of applications. With TQFE it is possible to have high levels of performance and precision at an optimum value-price ratio.

Main benefits

- High torsional stiffness
- High compactness
- Easy and quick installation
- Standardized flange for great compatibility

Main features

- Nominal output torque (Nm)
18 - 155
- Torsional backlash (arcmin)
5 - 12
- Torsional stiffness (Nm/arcmin)
6 - 60
- Max tilting moment (Nm)
12 - 110

Protection class

- IP54

Frame sizes

- 060
- 070
- 090

Main options

- Input versions
 - MOTOR ADAPTER
 - SOLID INPUT SHAFT
 - WITHOUT MOTOR ADAPTER
- Lubrication
 - STANDARD LUBRICATION
 - UH1 FOOD GRADE LUBRICATION



PRECISION PLANETARY RIGHT ANGLE GEARBOXES

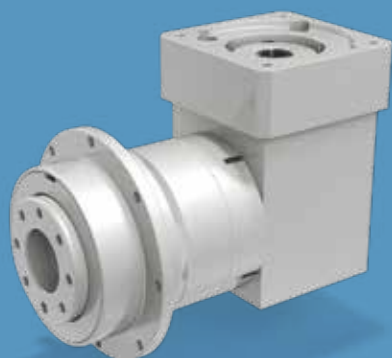

TQFEK Series

The TQFEK series offers optimized performance and features at an optimum value-price ratio.

An exceptionally compact and standardized flange interface combined with optimal positioning accuracy make it suitable for a wide range of industrial applications.

Its right-angle design allows more compactness for space-saving layouts.

Main benefits

- High torsional stiffness
- High compactness
- Easy and quick installation
- Standardized flange for great compatibility
- Compact design for space-saving layouts

Main features

- Nominal output torque (Nm)

18 - 155

- Torsional backlash (arcmin)

7 - 14

- Torsional stiffness (Nm/arcmin)

6 - 60

- Max tilting moment (Nm)

12 - 110

Main options

- Input versions

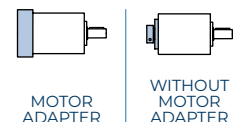

- Lubrication



Protection class

- IP54

Frame sizes

- 060
- 070
- 090

PRECISION PLANETARY INLINE GEARBOXES

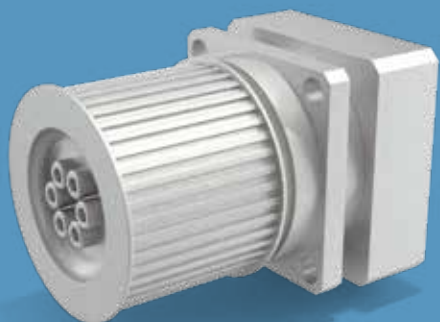

SL Series

The SL series features a compact design optimized for timing belt pulley drive systems.

This series represents the most suitable solution for belt servo-drives conveyors and all other applications requiring positioning accuracy, an ultra-compact size and high radial load capacity.

The output design compatible with market standards allows easy retrofits and a high level of freedom in projects development.

Main benefits

- Optimized for timing belt pulley drive systems
- Great position accuracy
- High compatibility for easy retrofits

Main features

- Nominal output torque (Nm)
18 - 155
- Torsional backlash (arcmin)
6 - 15
- Torsional stiffness (Nm/arcmin)
6 - 45
- Max tilting moment (Nm)
54 - 238

Protection class

- IP54

Frame sizes

- 070
- 090
- 120

Main options

- Input versions
 - MOTOR ADAPTER
 - WITHOUT MOTOR ADAPTER
- Output shafts versions
 - PULLEY
 - NO PULLEY
- Lubrication
 - STANDARD LUBRICATION
 - UH1 FOOD GRADE LUBRICATION
- High power version (P option)
 - HIGH POWER VERSION



LC Series

LC precision planetary gearboxes represent a flexible solution and valuable alternative with optimal performance and reliability levels.

The output design in line with market standards ensures great compatibility for easy retrofits and a high level of freedom in projects development.

Main benefits

- Cost effective yet powerful
- Highly reliable
- High compatibility for easy retrofits

Main features

- Nominal output torque (Nm)

10 - 450

- Torsional backlash (arcmin)

6 - 15

- Torsional stiffness (Nm/arcmin)

0.75 - 50

- Max tilting moment (Nm)

15 - 522

Protection class

- IP54

Frame sizes

- 050
- 070
- 090
- 120
- 155

Main options

- Input versions

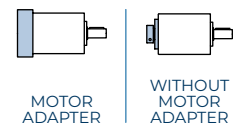

- Output shafts versions

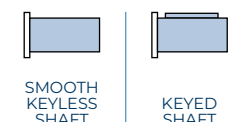

- Lubrication



- High power version (P option)





PRECISION PLANETARY RIGHT ANGLE GEARBOXES



LCK Series

LCK precision planetary right-angle gearboxes represent a flexible, reliable and cost-effective solution for machines that require a very compact layout.

The output design in line with market standards ensures great compatibility for easy retrofits and a high level of freedom in projects development.

Main benefits

- Cost effective yet powerful
- High compatibility for easy retrofits
- Compact design for space-saving layouts

Main features

- Nominal output torque (Nm)

10 - 450

- Torsional backlash (arcmin)

6 - 8

- Torsional stiffness (Nm/arcmin)

0.7 - 47.9

- Max tilting moment (Nm)

15 - 522

Protection class

- IP54

Frame sizes

- 050
- 070
- 090
- 120
- 155

Main options

- Input versions

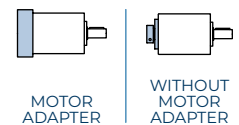

- Output shafts versions

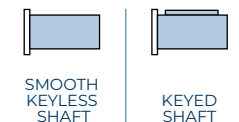

- Lubrication



- High power version (P option)



PRECISION PLANETARY INLINE GEARBOXES

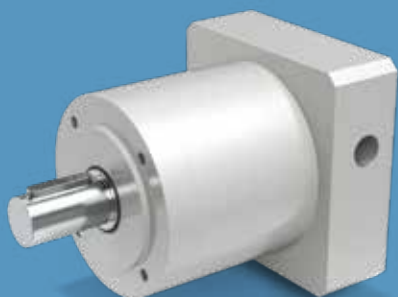

MPE Series

The MPE series offers a cost-effective solution for applications that require medium levels of positioning accuracy. It offers high flexibility in terms of sizes, ratios and mounting configurations for a variety of applications requirements. The output design in line with market standards ensures great compatibility for easy retrofits and a high level of freedom in projects development.

Main benefits

- Great price-performance ratio
- High compatibility for easy retrofits
- Suitable for a variety of applications thanks to great flexibility

Main features

- Nominal output torque (Nm)
5 - 155
- Torsional backlash (arcmin)
5 - 19
- Torsional stiffness (Nm/arcmin)
0.65 - 25
- Max tilting moment (Nm)
5 - 25

Protection class

- IP54

Frame sizes

- 040
- 060
- 080
- 120

Main options

- Input versions

MOTOR ADAPTER SOLID INPUT SHAFT WITHOUT MOTOR ADAPTER
- Output shafts versions

SMOOTH KEYLESS SHAFT KEYED SHAFT
- Lubrication

STANDARD LUBRICATION UH1 FOOD GRADE LUBRICATION



PRECISION PLANETARY RIGHT ANGLE GEARBOXES

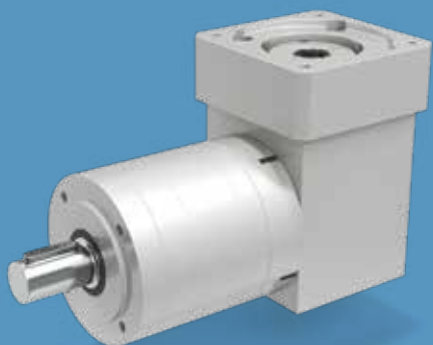

MPEK Series

The MPEK series offers medium levels of performance and position accuracy at a competitive value-price ratio. The output design in line with market standards ensures great compatibility for easy retrofits and a high level of freedom in projects development. Its right angle-design allows more compactness for space-saving layouts.

Main benefits

- Great price-performance ratio
- High compatibility for easy retrofits
- Suitable for a variety of applications thanks to great flexibility
- Compact design for space-saving layouts

Main features

- Nominal output torque (Nm)
18 - 155
- Torsional backlash (arcmin)
7 - 14
- Torsional stiffness (Nm/arcmin)
2.5 - 23.4
- Max tilting moment (Nm)
5.9 - 129

Protection class

- IP54

Frame sizes

- 060
- 080
- 120

Main options

- Input versions

MOTOR ADAPTER	WITHOUT MOTOR ADAPTER
- Output shafts versions

SMOOTH KEYLESS SHAFT	KEYED SHAFT
- Lubrication

STANDARD LUBRICATION	FOOD GRADE LUBRICATION



PRECISION PLANETARY RIGHT ANGLE GEARBOXES



KR Series

The KR flexible series represents an alternative for applications that require space-saving and medium precision levels. It is available in multiple configurations such as solid/hollow shaft, single/double shaft extension, shrink disk version or flange option.

Main benefits

- Space saving solution
- Optimized backlash
- Wide variety of configurations
- Optional reinforced bearings

Main features

- Nominal output torque (Nm)



- Torsional backlash (arcmin)



- Torsional stiffness (Nm/arcmin)

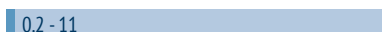

Protection class

- IP54

Frame sizes

- 010
- 020
- 030
- 040

Main options

- Input versions

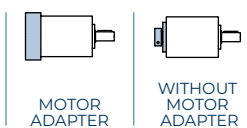

- Output shafts versions

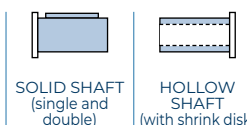

- Service type



- Bearings versions



INDUSTRIAL GEARMOTORS

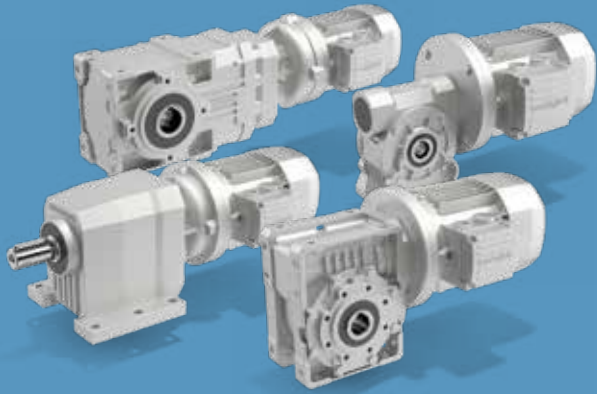

For over 60 years, we've been supporting our customers with solutions that perfectly match any industrial applications requirement. Bonfiglioli industrial gearmotors combine high efficiency, reliability, low maintenance costs and the widest torque range available on the market.

HELICAL BEVEL GEARMOTORS & GEAR UNITS

A Series

Torque range

- 100 ... 14,000 Nm

Gear ratios

- 4.9 ... 1,715

Mechanical rating

- 0.22 ... 150 kW

IN-LINE GEARMOTORS & GEAR UNITS

C Series

Torque range

- 45 ... 12,000 Nm

Gear ratios

- 2.6 ... 1,481

Mechanical rating

- 0.09 ... 213 kW

HELICAL PARALLEL-SHAFT GEARMOTORS & GEAR UNITS

F Series

Torque range

- 140 ... 14,000 Nm

Gear ratios

- 6.4 ... 2,099

Mechanical rating

- 0.09 ... 123 kW

UNIVERSAL WORM GEARMOTORS & GEAR UNITS

VF/W Series

Torque range

- 13 ... 7,100 Nm

Gear ratios

- 7 - 300 ... 2,300

Mechanical rating

- 0.04 ... 75 kW

INDUSTRIAL PLANETARY GEARMOTORS & GEAR UNITS

300M Series

Torque range

- 1,250 ... 1,286,000 Nm

Gear ratios

- 3.4 ... 2,916

Mechanical rating

- up to 1,050 kW



INTEGRATED DEVICES

COMPACT SERVO GEARMOTORS

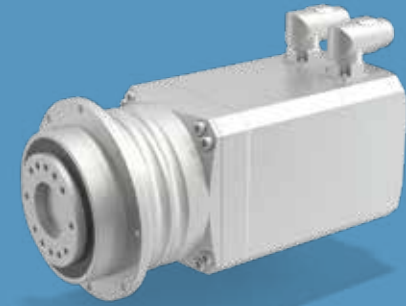

BMS Series

The BMS Series offers revolutionary space-saving machine design, a wider range of options and superior performance due to the synergy between permanent magnets, synchronous motors and precision planetary gearbox technologies. The excellent compactness, high torsional stiffness and low moment of inertia ensure a great operating performance in all applications that demand highly precise positioning, accuracy and efficiency. In addition, the BMS series provides a new and unique compact unit selection method, with optimized catalog combinations, to ensure the maximum output in terms of performance, compactness and drive optimization.

Rated speed

- 60 up to 875 rpm

Technical features

- 5 gearbox sizes: 060, 070, 090, 130, 160
- 3 overspeed variants: Base, Medium and High
- 6 motor frames and 14 motor sizes

Backlash

- 1 stage: less than 3 arcmin
- 2 stages: less than 5 arcmin

Operation

- Continuous duty
- Cyclic operation

Lubrication

- Life lubricated
- Optionally food grade oil

Feedback

- 2-pole resolver 8kHz & 10 kHz
- Optical single & multi turn EnDat encoder
- Optical single & multi-turn Hiperface encoder
- Capacitive single & multi-turn Hiperface encoder

Temperature sensor

- PTC
- KTY 84-130
- PT1000

Brake options

- Holding brake (optional)
- 24 Vdc

Degree of protection

- IP65

Key features

- Compact design
- High precision and dynamics
- Matching application demands and geared motor operating area, with a smaller servopackage
- Very flexible options

Maximum acceleration torque (Nm)

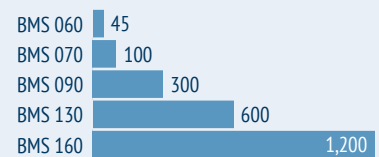

GEARMOTORS FOR AGVS & AMRS

(B) Basic

(A) Advanced

(C) Compact

PRECISION PLANETARY GEARBOX SERIES (B)

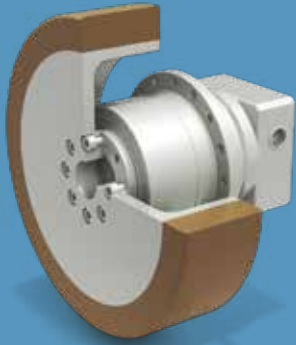

TQW Series

TQW is available in **three sizes**, with maximum support loads for single gearbox from 360 ... 1020 kg. For each gearbox size there is a **specific heavy-duty wheel** with a diameter of 160 mm, 200 mm or 250 mm. **Maximum speeds** of up to 2 m/s (7.2 km/h) are possible.

Gear ratios

- 9 ... 100

Degree of protection

- IP65

Backlash

- Less than 10 arcmin

Max radial force

- 2300 ... 5200 N

Maximum input speed

- 4000 ... 6000 rpm

Maximum load capacity

- 360 ... 1020 kg

Maximum speed

- <2m/s

Position precision

- 0.2 ... 0.3 mm

Weight (wheel included)

- 4,2 ... 18,1 kg

Key features

- Extremely compact
- High energy efficiency
- Output shaft supported by high load capacity bearings
- Highly reliable
- Life lubricated
- Designed for continuous and intermittence duty
- Extensive speed range

Nominal torque (Nm)

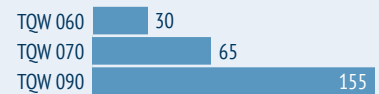

Max load capacity (kg)

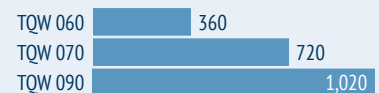



SERVO GEARMOTORS

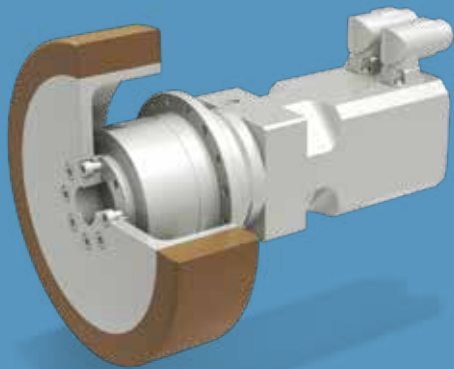

The BlueRoll Advanced servomotors are permanent magnet synchronous gearmotors with **highly compact dimensions** and **low inertia**. They meet the most stringent demands for precision, dynamics and speed settings thanks to their high-quality neodymium iron boron rare-earth magnets and optimized mechatronic integration. The solution allows great freedom in the **product customization**, thanks to the **wide range of options**, for an **optimized and flexible servo package**.

Key features

All the BlueRoll Basic benefits and in addition:

- Highly customizable solution
- Specific matching between the individual application demands and the gearmotor's operating area
- Wide range of encoders and protocols suitable for safety PLCs
- Configurable connectors or flying cable

BlueRoll Advanced and Compact motor specifications

Power supply

- Customized winding for low voltage supply (i.e. 48Vdc)

Sizes

- 4 motor frame

Stall Torque

- 0.85 ... 5.60 Nm

Rated speed

- 1600, 3000, 4500, 6000 rpm

Degree of protection

- IP 65, IP 67

Brake

- Holding brake
- Safety brake

Feedback options

- Resolver
- Absolute Encoders: Hiperface, Hiperface DSL, SinCos, EnDat 2.2
- Safety encoders available

EXTRA COMPACT SERVO GEARMOTORS

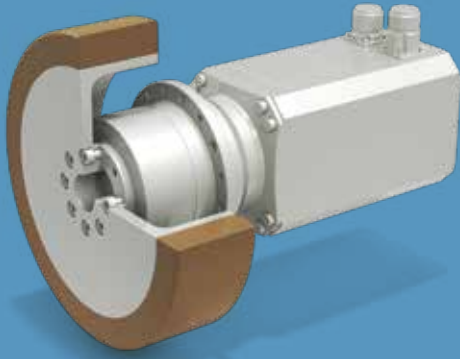

Reach the **highest level of customization and compactness** with our **complete solution**, characterized by **fully tested** and **validated dimensioning** tailored to your specific requirements. Developed to respond to customer's requests, the extreme compactness of this fully customizable solution allows **greater flexibility in the design** of your AGV application.

Key features

All the BlueRoll Advanced benefits and in addition:

- 25% more compact
- Optimized performances
- Easier mounting and improved installation space

Customization options

BlueRoll platform can be extensively customized in order to meet your specific application requirements (e.g. encoder, type, voltage supply, rough environments design).

OUR GLOBAL PRESENCE

Thanks to an international network of closely interconnected commercial and production sites, we can guarantee the same high standards of Bonfiglioli quality anywhere at any given time. We know that our direct presence in local markets is the key to long-lasting success, so our family includes 15 production sites, 24 commercial sites and more than 550 distributors around the world.

Our organization is always close by, offering complete and efficient solutions and supporting our customers with dedicated services, co-engineering and after-sales assistance.



15
PRODUCTION SITES



24
COMMERCIAL SITES



80
COUNTRIES



550
DISTRIBUTORS



~4.000
PEOPLE

AUSTRALIA

Bonfiglioli Transmission (Aust.) Pty Ltd

2, Cox Place Glendenning NSW 2761
Locked Bag 1000 Plumpton NSW 2761
Tel. +61 2 8811 8000



BRAZIL

Bonfiglioli Redutores do Brasil Ltda

Travessa Cláudio Armando 171 - Bloco 3
CEP 09861-730 - Bairro Assunção
São Bernardo do Campo - São Paulo
Tel. +55 11 4344 2322



CHINA

Bonfiglioli Drives (Shanghai) Co. Ltd.

#68, Hui-Lian Road, QingPu District,
201707 Shanghai
Tel. +86 21 6700 2000



Motion & Robotics

#568, Longpan Road, Jiading District,
201707 Shanghai



Bonfiglioli Trading (Shanghai) Co. Ltd.

Room 423, 4th Floor, #38, Yinglun Road,
China (Shanghai) Pilot Free Trade Zone,
Shanghai



FRANCE

Bonfiglioli Transmission s.a.

14 Rue Eugène Pottier
Zone Industrielle de Moimont II
95670 Marly la Ville
Tel. +33 1 34474510



GERMANY

Bonfiglioli Deutschland GmbH

Sperberweg 12 - 41468 Neuss
Tel. +49 0 2131 2988 0



Bonfiglioli Vectron GmbH

Europark Fichtenhain B6 - 47807 Krefeld
Tel. +49 0 2151 8396 0



O&K Antriebstechnik GmbH

Ruhrallee 8-12 - 45525 Hattingen
Tel. +49 0 2324 2050 1



INDIA

Bonfiglioli Transmission Pvt. Ltd.

Mobility & Wind Industries
AC 7 - AC 11 Sidco Industrial Estate
Thirumudivakkam Chennai - 600 044
Tel. +91 844 844 8649



Discrete Manufacturing & Process Industries - Motion & Robotics

Survey No. 528/1,
Perambakkam High Road Mannur
Village,
Sriperumbudur Taluk Chennai - 602 105
Tel. +91 844 844 8649



Discrete Manufacturing & Process Industries

Plot No.A-9/5, Phase IV MIDC Chakan,
Village Nighoje Pune - 410 501
Tel. +91 844 844 8649



ITALY

Bonfiglioli Riduttori S.p.A.

Discrete Manufacturing & Process Industries
Via Cav. Clementino Bonfiglioli, 1
40012 Calderara di Reno
Tel. +39 051 6473111



Discrete Manufacturing & Process Industries

Via Sandro Pertini, lotto 7b
20080 Carpiano
Tel. +39 02985081



Discrete Manufacturing & Process Industries

Via Saliceto, 15 - 40010 Bentivoglio



Mobility & Wind Industries

Via Enrico Mattei, 12 Z.I. Villa Selva
47122 Forlì
Tel. +39 0543 789111



Motion & Robotics

Via Unione, 49 - 38068 Rovereto
Tel. +39 0464 443435/36



NEW ZEALAND

Bonfiglioli Transmission (Aust.) Pty Ltd

88 Hastie Avenue, Mangere Bridge,
2022 Auckland
PO Box 11795, Ellerslie
Tel. +64 09 634 6441



SINGAPORE

Bonfiglioli South East Asia Pte Ltd

8 Boon Lay Way, #04-09,
8@ Tadehub 21, Singapore 609964
Tel. +65 6268 9869



SLOVAKIA

Bonfiglioli Slovakia s.r.o.

Robotnícka 2129
Považská Bystrica, 01701 Slovakia
Tel. +421 42 430 75 64



SOUTH AFRICA

Bonfiglioli South Africa Pty Ltd.

55 Galaxy Avenue, Linbro Business Park,
Sandton, Johannesburg
2090 South Africa
Tel. +27 11 608 2030



SPAIN

Tecnotrans Bonfiglioli S.A

Pol. Ind. Zona Franca, Sector C,
Calle F, nº 6 - 08040 Barcelona
Tel. +34 93 447 84 00



TURKEY

Bonfiglioli Turkey Jsc

Atatürk Organize Sanayi Bölgesi,
10007 Sk. No. 30
Atatürk Organize Sanayi Bölgesi,
35620 Çiğli - İzmir
Tel. +90 0 232 328 22 77



UNITED KINGDOM

Bonfiglioli UK Ltd.

Unit 1 Calver Quay, Calver Road, Winwick
Warrington, Cheshire - WA2 8UD
Tel. +44 1925 852667



USA

Bonfiglioli USA Inc.

3541 Hargrave Drive
Hebron, Kentucky 41048
Tel. +1 859 334 3333



VIETNAM

Bonfiglioli Vietnam Ltd.

Lot C-9D-CN My Phuoc Industrial Park 3
Ben Cat - Binh Duong Province
Tel. +84 650 3577411



 PRODUCTION

 ASSEMBLY

 SALES

 SERVICE





We have a relentless commitment to excellence, innovation & sustainability. Our team creates, distributes and services world-class power transmission & drive solutions to keep the world in motion.

HEADQUARTERS

Bonfiglioli S.p.A

Registered office: Via Cav. Clementino Bonfiglioli, 1
40012 Calderara di Reno - Bologna (Italy)
Tel. +39 051 6473111

Head office: Via Isonzo, 65/67/69
40033 Casalecchio di Reno - Bologna (Italy)

