

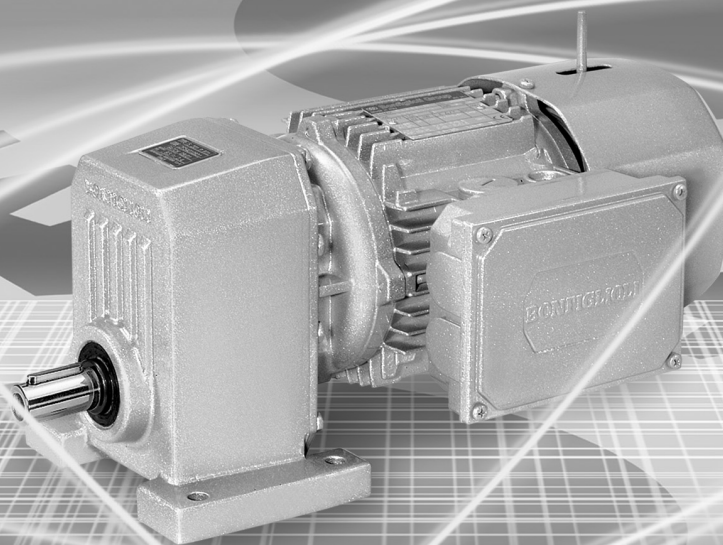













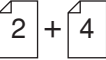

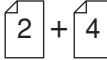
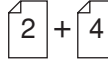
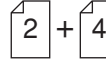
*Lista parti di ricambio - Spare parts list - Ersatzteilliste  
Liste des pieces detachees - Lista de partes de recambio*

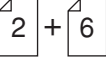
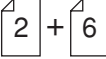
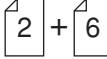
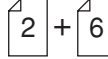
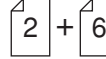
**S**



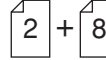

**Quadro d'unione delle tavole parti di ricambio**  
***Index of spare parts tables***  
**Inhaltsverzeichnis Ersatzteillisten**  
***Index des tables de pièces de rechange***  
**Índice de la tabla de partes de recambio**

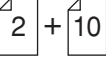
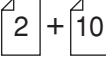
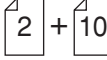
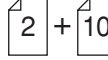
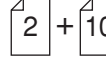
<b>INPUT</b>	<b>S 10 1</b>	<b>S 20 1</b>	<b>S 30 1</b>	<b>S 40 1</b>	<b>S 50 1</b>
 <b>S_</b>					
 <b>P63 ... P132</b>					
 <b>P160 ... P180</b>					
 <b>HS</b>					

S 10

S 20

S 30





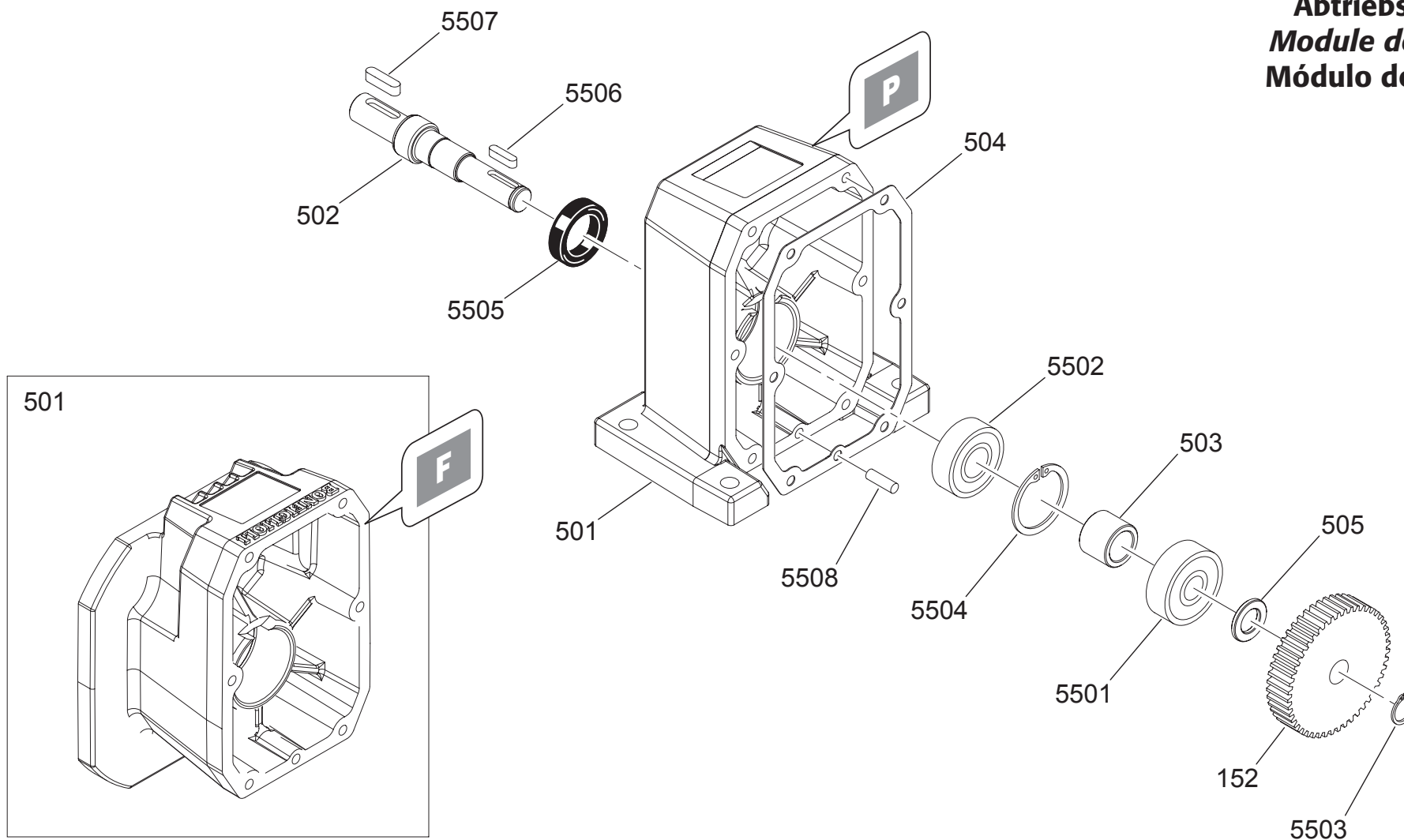

S 40

S 50

**Modulo uscita**  
**Output sub-assembly**  
**Abtriebseinheit**  
**Module de sortie**  
**Módulo de salida**



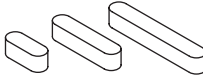



Pos.	Descrizione	Description	Benennung	Description	Descripción
152	Corona	Gear	Zahnrad	Couronne	Corona
501	Cassa	Housing	Gehäuse	Carter	Caja
502	Albero lento	Output shaft	Abtriebswelle	Arbre de sortie	Eje de salida
503	Distanziale	Spacer ring	Distanzring	Entretoise	Distanciador
504	Guarnizione	Gasket	Dichtung	Joint plat	Junta

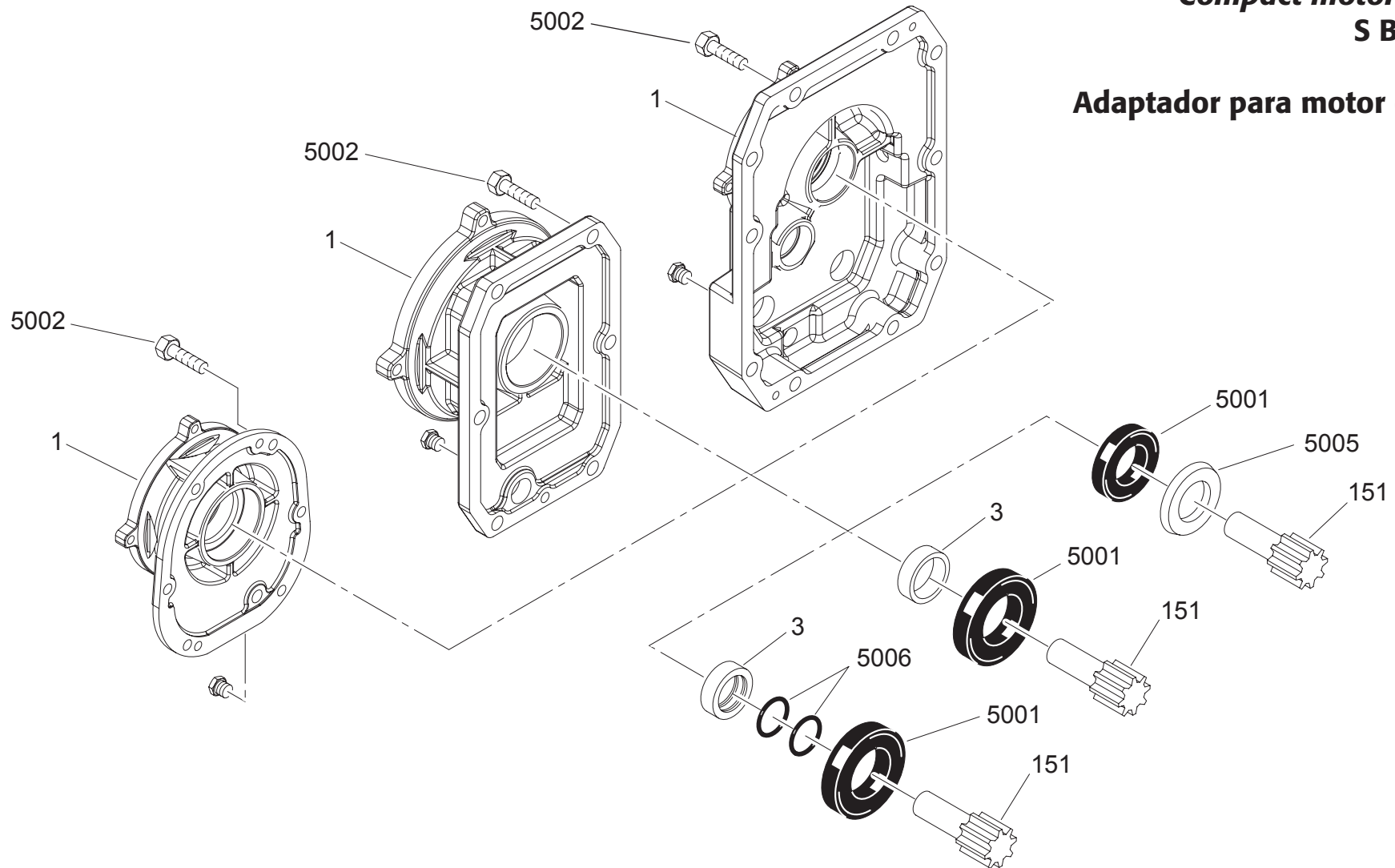

									
	5501	5502	5504	5503	5508	5506	5507	505	5505
S 10	6301	6202	DI 35	DE 12	ø5x16	4x4x16 C	5x5x20 A	12.2x16.8x0.5	20x30x7 DL
S 20	6303	6303	DI 47	DE 15	ø5x16	5x5x17 C	6x6x35 A	26.9x15.5x3	25x42x7 DL
S 30	6304	6304	DI 52	DE 17	ø6x16	5x5x19 C	8x7x40 A	17.2x27.8x0.5	30x42x7 DL
S 40	6305	6305	DI 62	DE 20	ø6x16	6x6x25 C	8x7x50 A	20.5x34.8x1	35x52x7 DL
S 50	6307	6307 V3 - V6 6307-2RS	DI 80	DE 25	ø6x16	8x7x25 C	10x8x60 A	25.2x48.8x1	50x72x8 DL

**Interfaccia per motore compatto**  
**Compact motor interface**  
**S Baueinheit**  
**Module S**  
**Adaptador para motor compacto**



Pos.	Descrizione	Description	Benennung	Description	Descripción
1	Coperchio	Cover	Deckel	Couvercle	Tapa
3	Boccola	Bushing	Buchse	Douille	Casquillo
151	Pignone	Pinion gear	Ritzel	Pignon	Piñon

	 5001				 5005			 OR 5006	
	S 10	S 20	S 30	S 40 - S 50	S 10 - S 20	S 30	S 40 - S 50	S 20 - S 30	S 40 - S 50
<b>S05</b>	20x35x7 L	20x35x7 L			20x35x4				
<b>S1</b>	20x35x7 L 25x35x7 L	20x35x7 L 25x35x7 L	20x35x7 L 25x35x7 L	20x35x7 L 25x35x7 L	20x35x4	20x35x4	20x35x4		
<b>S2</b>	35x55x8 L	35x55x8 L 42x55x8 L	35x55x8 L 42x55x8 L	35x55x8 L 42x55x8 L	35x52x4.5	35x52x4.5	35x52x4.5		
<b>S3</b>	35x62x7 L	35x62x7 L 48x62x8 L	35x62x7 L 48x62x8 L	35x62x7 L 48x62x8 L	35x52x4.5	35x52x4.5	35x52x4.5	4137	4137
<b>S4</b>				45x85x10 L 65x85x10 L			45x62x4.5		149

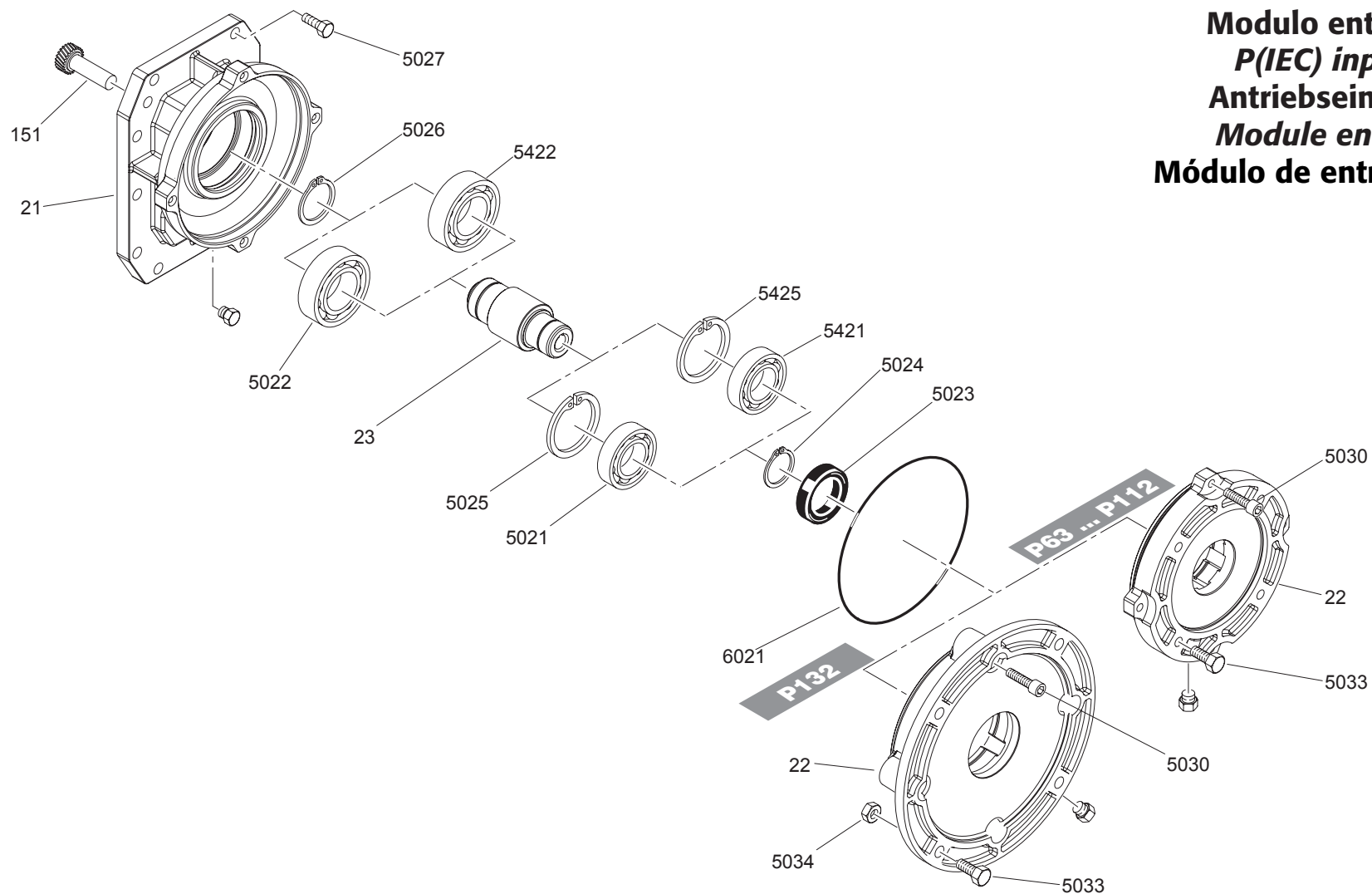

	 5002				
	S 10	S 20	S 30	S 40	S 50
<b>S05</b>	M6x18 M6x20 M6x22	M6x20			
<b>S1</b>	M6x20 M6x22	M6x16 M6x18 M6x20 M6x22	M8x25	M8x25	M10x25 M10x30
<b>S2</b>	M6x20 M6x22	M6x20 M6x22	M8x25	M8x20 M8x25	M10x25 M10x30
<b>S3</b>	M6x20 M6x22	M6x20 M6x22	M8x25	M8x20 M8x25	M10x25 M10x30
<b>S4</b>				M8x20 M8x25	M10x25 M10x30







**Modulo entrata P(IEC)**  
**P(IEC) input module**  
**Antriebseinheit P(IEC)**  
**Module entree P(IEC)**  
**Módulo de entrada P(IEC)**

Pos.	Descrizione	Description	Benennung	Description	Descripción
21	Coperchio	Cover	Deckel	Couvercle	Tapa
22	Flangia	Flange	Flansch	Bride	Brida
23	Albero veloce	Input shaft	Antriebswelle	Arbre rapide	eje de salida
151	Pignone	Pinion gear	Ritzel	Pignon	Piñon









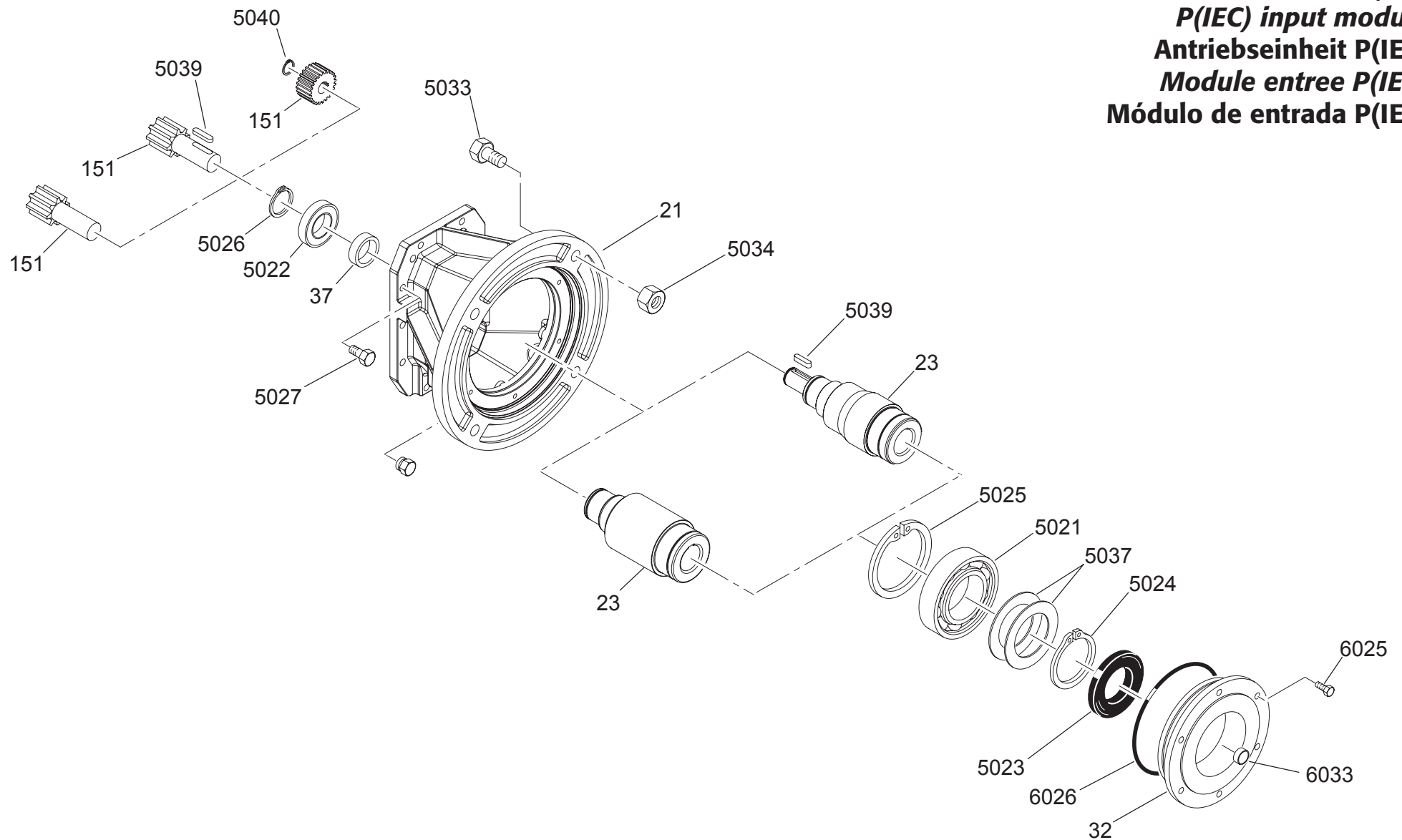







	 5027					5030	5033	 OR 6021		 5034
	S 10	S 20	S 30	S 40	S 50			S 10 ... S 30	S 40 - S 50	
<b>P63</b>	M6x20	M6x20 M6x22	M8x25	M8x20 M8x25	M10x25 M10x30	M5x20	M8x20	3475	3475	
<b>P71</b>	M6x20 M6x22	M6x20 M6x22	M8x25	M8x20 M8x25	M10x25 M10x30	M5x20	M8x20	3475	3475	
<b>P80</b>	M6x20 M6x22	M6x20 M6x22	M8x25	M8x20 M8x25	M10x25 M10x30	M6x25	M10x22	3575	3575	
<b>P90</b>	M6x20 M6x22	M6x20 M6x22	M8x25	M8x20 M8x25	M10x25 M10x30	M6x25	M10x22	3575	3575	
<b>P100</b> <b>P112</b>	M6x20 M6x22	M6x20 M6x22	M8x25	M8x20 M8x25	M10x25 M10x30	M6x30	M12x30	3575	3800	
<b>P132</b>				M8x20 M8x25	M10x25 M10x30	M8x25	M12x50		3800	M12

	 5023	5021	 5022					5421	5422	 5024 5026		5025	 5425
			S 10	S 20	S 30	S 40	S 50			S 40 - S 50		S 40 - S 50	
<b>P63</b>	25x42x7 L	6005-2RS 6005-2RS WT	6006	6006 6006 2Z 6006-2RS WT	6006	6006	6006			25	30	47	
<b>P71</b>	25x42x7 L	6005-2RS 6005-2RS WT	6006	6006 6006 2Z 6006-2RS WT	6006	6006	6006			25	30	47	
<b>P80</b>	40x62x7 L	6008-2RS 6008-2RS WT	6007 6007 ETN9	6007 6007-2Z 6007-2RS WT 6007 ETN9	6007 6007 ETN9	6007 6007 ETN9	6007 6007 ETN9			40	35	68	
<b>P90</b>	40x62x7 L	6008-2RS 6008-2RS WT	6007 6007 ETN9	6007 6007-2Z 6007-2RS WT 6007 ETN9	6007 6007 ETN9	6007 6007 ETN9	6007 6007 ETN9			40	35	68	
<b>P100</b> <b>P112</b>	45x72x8 L	6009-2RS 6009-2RS WT 6012-2RS	6007 ETN9	6007 ETN9 6007 6007-2Z 6007-2RS WT	6007 ETN9	6209	6209			45	35	75	
<b>P132</b>	55x80x8 L	6012-2RS WT				6209	6209	6012-2RS	6209	60	45	95	95

**Modulo entrata P(IEC)**  
***P(IEC) input module***  
**Antriebseinheit P(IEC)**  
***Module entree P(IEC)***  
**Módulo de entrada P(IEC)**



Pos.	Descrizione	Description	Benennung	Description	Descripción
21	Coperchio	Cover	Deckel	Couvercle	Tapa
23	Albero veloce	Input shaft	Antriebswelle	Arbre rapide	eje de salida
32	Cappello per cuscinetto	Bearing holder	Deckel	Capuchon	Sombbrero para rodamiento
37	Distanziale	Spacer ring	Distanzring	Entretoise	Distanciador
151	Pignone	Pinion gear	Ritzel	Pignon	Piñon







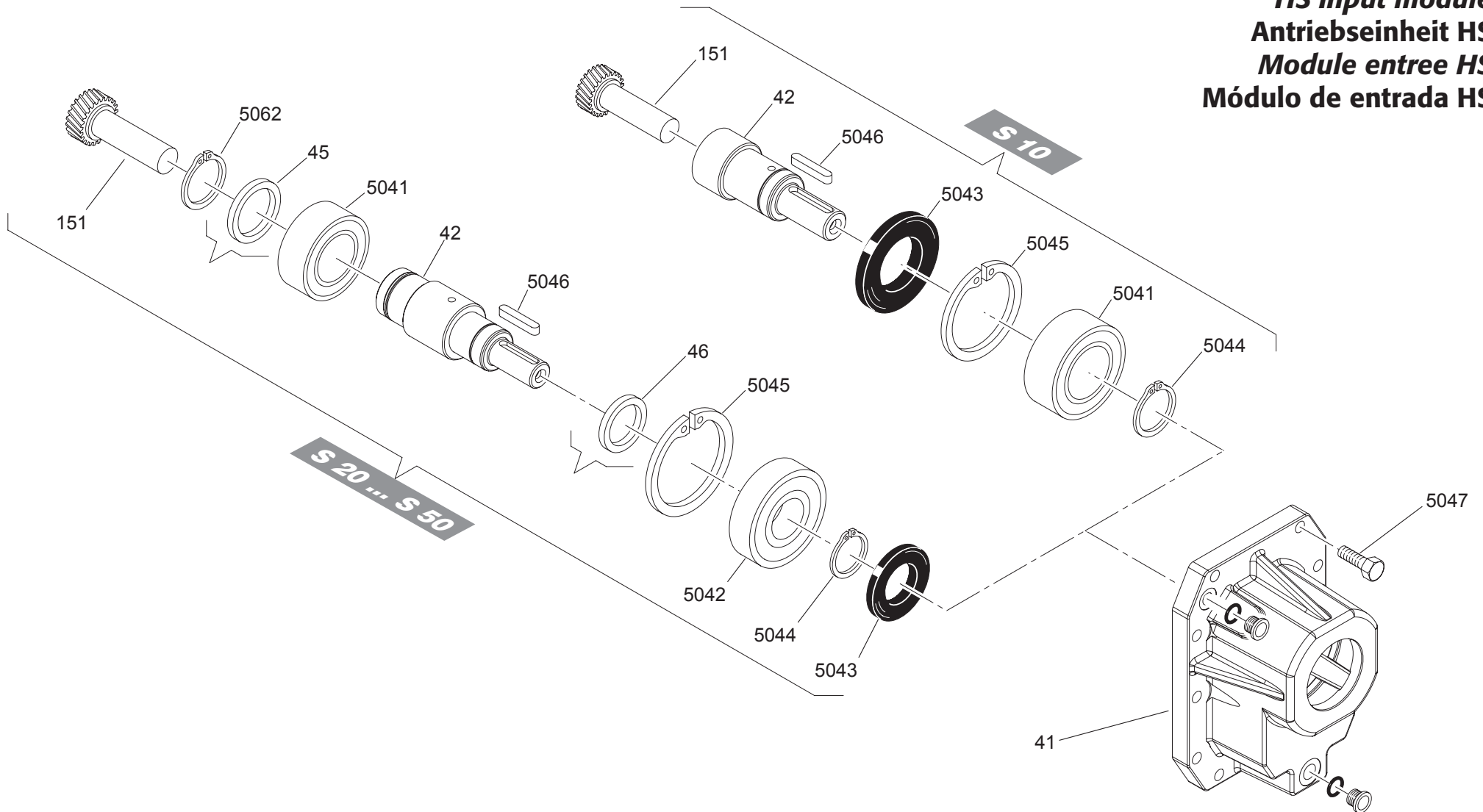

														 OR
	5021	5022	5039	5024	5026	5040	5025	5037	5034	5023	5027	5033	6025	6026
P160	6016 6016 2RS	NUP310 6310	8x7x45 A	80	50	30	140	80x100x2 P	M16	80x110x10 L	M10x30 M10x35 M10x45	M16x60	M8x25	3725
P180	6016 6016 2RS	NUP310 6310 6212	8x7x45 A 14x9x57 C	80	50 60	30 48	140	80x100x2 P	M16	80x110x10 L	M10x30 M10x35 M10x45	M16x60	M8x25	3725

**S 10****S 20****S 30****S 40****S 50****HS**

**Modulo entrata HS**  
**HS input module**  
**Antriebseinheit HS**  
**Module entree HS**  
**Módulo de entrada HS**



Pos.	Descrizione	Description	Benennung	Description	Descripción
41	Coperchio	Cover	Deckel	Couvercle	Tapa
42	Albero veloce	Input shaft	Antriebswelle	Arbre rapide	eje de salida
45	Distanziale	Spacer ring	Distanzring	Entretoise	Distanciador
46	Distanziale	Spacer ring	Distanzring	Entretoise	Distanciador
151	Pignone	Pinion gear	Ritzel	Pignon	Piñon

								
	5041	5042	5043	5046	5044	5062	5045	5047
<b>S 10</b>	3206-2RS		35x62x7 L	5x5x35 A	30		62	T.E. M6x20 T.E. M6x22
<b>S 20</b>	6007	6206-2RS	30x52x7 L	6x6x35 A	30	35	62	T.E. M6x20 T.E. M6x22
<b>S 30</b>	6207	6306-2RS	30x52x7 L	6x6x35 A	30	35	72	T.E. M8x25 T.E. M8x30
<b>S 40</b>	6007	6206-2RS	30x52x7 DL	6x6x35 A	30	35	62	T.E. M8x25 T.E. M6x20
<b>S 50</b>	6210 <b>i = 18.9...21.1</b> NUP 210 <b>i = 2.6...16.6</b>	6308-2RS	40x62x7 DL	8x7x45 a	40	50	90	T.E. M10x35

## R0

	Descrizione	Description	Benennung	Description	Descripción

Questa pubblicazione annulla e sostituisce ogni precedente edizione o revisione. Ci riserviamo il diritto di apportare modifiche senza preavviso. E' vietata la riproduzione anche parziale senza autorizzazione.

*This publication cancels and replaces any previous edition and revision. We reserve the right to implement modifications without notice. This catalogue cannot be reproduced, even partially, without prior consent.*

Diese Veröffentlichung annulliert und ersetzt jeder hergehende Edition oder Revision. BONFIGLIOLI behält sich das Recht vor, Änderungen ohne vorherige Informationen durchzuführen.

*Cette publication annule et remplace toutes les autres précédentes. Nous nous réservons le droit d'apporter toutes modifications à nos produits. La reproduction et la publication partielle ou totale de ce catalogue est interdite sans a autorisation.*

Esta publicación anula y sustituye toda anterior edición o revisión. Nos reservamos el derecho de aportar modificaciones sin previo aviso. Se prohíbe la reproducción incluso parcial sin autorización.

Bonfiglioli Worldwide & BEST Partners

AUSTRALIA

BONFIGLIOLI TRANSMISSION (Aust) Pty Ltd.  
48-50 Adderley St. (East) Auburn (Sydney) N.S.W. 2144  
Tel. (+61) 2 8748 4400 - Fax (+61) 2 9748 8740  
P.o. Box 6705 Silverwater NSW 1811  
www.bonfiglioli.com.au - sales@bonfiglioli.com.au

AUSTRIA 

MOLL MOTOR GmbH  
Industriestrasse 8 - 2000 Stockerau  
Tel. (+43) 2266 63421-DW - Fax (+43) 6342 180 - Tlx 61 32 22 348 Molla  
www.mollmotor.at - office@mollmotor.at

BELGIUM 

N.V. ESCO TRANSMISSION S.A.  
Culliganlaan 3 - 1831 Machelem Diegem  
Tel. 0032 2 7204880 - Fax 0032 2 7212827 - Tlx 21930 Escopo B  
www.escotrans.be - info@escotrans.be

BRASIL 

ATI BRASIL  
Rua Omlio Monteiro Soares, 260 - Vila Fanny - 81030-000  
Tel. (+41) 334 2091 - Fax (+41) 332 8669  
www.atibrasil.com.br - vendas@atibrasil.com.br

CANADA

BONFIGLIOLI CANADA INC.  
2-7941 Jane Street - Concord, ONTARIO L4K 4L6  
Tel. (+1) 905 7384466 - Fax (+1) 905 7389833  
www.bonfigliolicanada.com - sales@bonfigliolicanada.com

CZECH 

OPIS Engineering k.s.  
614 00 Brno, Selkská 64  
Tel. +420 543330057 - Fax +420 543242653  
www.opis.cz - info@opis.cz

FRANCE

BONFIGLIOLI TRANSMISSIONS S.A.  
14 Rue Eugène Pottier BP 19  
Zone Industrielle de Moimont II - 95670 Marly la Ville  
Tel. (+33) 1 34474510 - Fax (+33) 1 34688800  
www.bonfiglioli.fr - btf@bonfiglioli.fr

GERMANY

BONFIGLIOLI DEUTSCHLAND GmbH  
Hamburger Straße 18 - 41540 Dormagen  
Tel. (+49) 2133 50260 - Fax (+49) 2133 502610  
www.bonfiglioli.de - info@bonfiglioli.de

GREAT BRITAIN

BONFIGLIOLI UK Ltd  
Unit 3 Colemeadow Road - North Moons Moat  
Redditch, Worcestershire B98 9PB  
Tel. (+44) 1527 65022 - Fax (+44) 1527 61995  
www.bonfiglioli.co.uk - manwaha@bonfiglioli.com

BONFIGLIOLI (UK) LIMITED  
5 Grosvenor Grange - Woolston - Warrington, Cheshire WA1 4SF  
Tel. (+44) 1925 852667 - Fax (+44) 1925 852668  
www.bonfiglioliuk.co.uk - sales@bonfiglioliuk.co.uk

GREECE

BONFIGLIOLI HELLAS S.A.  
O.T. 48A T.O. 230 - C.P. 570 22 Industrial Area - Thessaloniki  
Tel. (+30) 2310 796456 - Fax (+30) 2310 795903  
www.bonfiglioli.gr - info@bonfiglioli.gr

HOLLAND 

ELSTO AANDRIJFTECHNIEK  
Loosterweg, 7 - 2215 TL Voorhout  
Tel. (+31) 252 219 123 - Fax (+31) 252 231 660  
www.elsto.nl - imfo@elsto.nl

HUNGARY 

AGISYS AGITATORS & TRANSMISSIONS Ltd  
2045 Törökbálint, Tő u.2. Hungary  
Tel. +36 23 50 11 50 - Fax +36 23 50 11 59  
www.agisys.hu - info@agisys.com

INDIA

BONFIGLIOLI TRANSMISSIONS PVT Ltd.  
PLOT AC7-AC11 Sidco Industrial Estate  
Thirumudivakkam - Chennai 600 044  
Tel. +91(0)44 24781035 / 24781036 / 24781037  
Fax +91(0)44 24780091 / 24781904  
www.bonfiglioli.co.in - bonfig@vsnl.com

ITALY

A.T.I. di Morganti E. C. sas   
Via Pistoiese 219 - 50047 Prato (PO)  
Tel. 0574/6961 - Fax 0574/790996  
www.atimorganti.it - ati.morganti@texnet.it

BONETTI LUIGI SRL   
Strada Padana Superiore verso VR n.7 - 36100 Vicenza (VI)  
Tel. 0444/563120 - Fax 0444/961979  
www.bonettimotoriduttori.com - bonetti.luigi@libero.it

CASA DEL CUSCINETTO SAS di Castignoli e C.   
Strada Val Nure 18/a - 29100 Piacenza (PC)  
Tel. 0523/755518 - 0523/756315 - Fax 0523/457804  
www.casadelcuscinetto.net - antonio@casadelcuscinetto.net

CENTO TRASMISSIONI SRL   
Via Friuli 23 - 40060 Osteria Grande (BO)  
Tel. 051/6958222 - Fax 051/6958253  
www.centotrasmissioni.com - cento@centotrasmissioni.com

CONTASTA COMPONENTI SRL   
di Franca Di Clemente e Figli  
Via Po 65/67 - Zona Comm. 66020 S. Giovanni Teatino (CH)  
Tel. 085/4462696 - Fax 085/4461754  
www.grupppofit.it - grupppofit@grupppofit.it

D.L. di Danielli B e Lollì G. SRL   
Via Fucini 2 - 40132 Bologna  
Tel. 051/6177611 - Fax 051/6177630  
www.daniellirolli.it - info@daniellirolli.it

EGA TECNIC SRL   
Via Maccani 171/2 - 38100 Trento  
Tel. 0461 822176 - Fax 0461 821643  
www.egatecnic.it - info@egatecnic.it

FIMU S.R.L.   
Via Artigianato - 25128 Savigliano (CN)  
Tel. 0172/713542 - Fax 0172/715489  
www.fimusr.com - fimu@fimusr.com

FITMA S.R.L.   
Viale del Commercio 10 - 37042 Caldiero (VR)  
Tel. 045/6132511 - Fax 045/6150270  
www.fitma.it - fitma@fitma.it

F.M.I. FRANCESCHI S.R.L.   
Strada Baganzola 28/a - 43100 Parma  
Tel. 0521/992200 - Fax 0521/987303  
www.fimiparma.it - fmi@fimiparma.it

INDUSTRIAL FURNITURE MORO SNC   
Via dei Da Prata 34 - 31100 Treviso  
Tel. 0422 428835 - Fax 0422/428830  
www.morotreviso.com - info@morotreviso.com

MICAR Snc di Sandro Arminio e C.   
Via Rosso di S. Secondo, 15 - 20134 Milano  
Tel. 02/7491091 - Fax 02/70126372  
www.micar.it - info@micar.it

MINETTI SPA FILIALE DI BERGAMO   
Via Canovine, 14 - 24100 Bergamo  
Tel. 035/327111 - Fax 035/316767  
www.minettigroup.com - minettibergamo@minettigroup.com

MINETTI SPA FILIALE DI BRESCIA   
Via G. di Vittorio, 38 - Z.I. - 25128 Brescia  
Tel. 030/3582734 - Fax 030/3582760  
www.minettigroup.com - minettibrescia@minettigroup.com

S.I.R.I. SRL   
Via Dell'Industria 9 - 04011 Aprilia (LT)  
Tel. 06/9206291 - Fax 06/9258643  
www.sirisrl.com - info@sirisrl.com

SAROK ITALIA SRL   
Via Valsugana, 4 - 22053 Lecco (CO)  
Tel. 0341/357811 - Fax 0341/283096  
www.sarok.it - sarokitalia@sarok.it

SAROK DUE SRL   
Via 1 Maggio 9/11 - 20028 S. Vittore Olona (MI)  
Tel. 0331/423911 - Fax 0331/423942  
www.sarok.it - sarok2@tin.it

T.I.M. Tecn.Ind. Modenesi   
Via Franz Leahr 25 - 41100 Modena  
Tel. 059/282500 - Fax 059/282404  
www.timmodena.com - timmodena@timmodena.com

TECHNOBI SRL   
Via Lazio, 65 - 20090 Buccinasco (MI)  
Tel. 02/45712362 - Fax 02/45712219  
www.technobi.it - technobi@libero.it

TECNICA INDUSTRIALE SRL   
S.P. 231 km 1 ex S.S.98 Km 80,176 - 70026 Modugno (BA)  
Tel. 080/5367089 - 080/5367090 - Fax 080/5367091  
www.tecnicaindustriale.it - info@tecnicaindustriale.it

TECNOFORNITURE SRL   
Via Pasubio 106 - 63037 Porto d'Ascoli (AP)  
Tel. 0735/76171 - Fax 0735/655266  
www.tecnoforniture.it - info@tecnoforniture.it

V.B. Moto Trasmissioni s.n.c.   
di Volpe E. E Bianchi P. E. C.  
Via Enzo Ferrari 335 - 47037 Cesena (FO)  
Tel. 0547/630610 - Fax 0547/630615  
www.vbmototrasmissioni.it - info@vbmototrasmissioni.it

VENETA BEARINGS SRL   
Via Torino 15 - 35035 Mestrino (PD)  
Tel. 049/9001944 - 049/9001549 - Fax 049/9001543  
www.venetabearings.it - info@venetabearings.it

NEW ZEALAND 

SAECO BEARINGS TRANSMISSION  
36 Hastie Avenue, MangerePo Box 22256, Otahuhu - Auckland  
Tel. +64 9 634 7540 - Fax +64 9 634 7552  
mark@saeco.co.nz

POLAND 

POLPACK Sp. z o.o. - Ul. Chrobrego 135/137 - 87100 Torun  
Tel. 0048.56.6559235 - 6559236 - Fax 0048.56.6559238  
www.polpack.com.pl - polpack@polpack.com.pl

RUSSIA 

FAM  
57, Maly prospekt, V.O. - 199048, St. Petersburg  
Tel. +7 812 3319333 - Fax +7 812 3271454  
www.fam-drive.ru - info@fam-drive.ru

SPAIN

TECNOTRANS SABRE S.A.  
Pol. Ind. Zona Franca sector C, calle F, nº 08040 Barcelona  
Tel. (+34) 93 4478400 - Fax (+34) 93 3360402  
www.tecnotrans.com - tecnotrans@tecnotrans.com

SOUTH AFRICA

BONFIGLIOLI POWER TRANSMISSION Pty Ltd.  
55 Galaxy Avenue, Linbro Business Park - Sandton  
Tel. (+27) 11 608 2030 OR - Fax (+27) 11 608 2631  
www.bonfiglioli.co.za - bonfigsales@bonfiglioli.co.za

SWEDEN

BONFIGLIOLI SKANDINAVIEN AB  
Kontorsgatan - 234 34 Lomma  
Tel. (+46) 40 412545 - Fax (+46) 40 414508  
www.bonfiglioli.se - info@bonfiglioli.se

THAILAND 

K.P.T MACHINERY (1993) CO.LTD.  
259/83 Soi Phiboonves, Sukhumvit 71 Rd. Phrakhanong-nur,  
Wattana, Bangkok 10110  
Tel. 0066.2.3913030/7111998  
Fax 0066.2.7112852/3811308/3814905  
www.kpt-group.com - sales@kpt-group.com

USA

BONFIGLIOLI USA INC  
1000 Worldwide Boulevard - Hebron, KY 41048  
Tel.: (+1) 859 334 3333 - Fax: (+1) 859 334 8888  
www.bonfiglioliusa.com  
industrialsales@bonfiglioliusa.com  
mobilesales@bonfiglioliusa.com

VENEZUELA 

MAQUINARIA Y ACCESORIOS IND.-C.A.  
Calle 3B - Edif. Comindu - Planta Baja - Local B  
La Urbina - Caracas 1070  
Tel. 0058.212.2413570 / 2425268 / 2418263  
Fax 0058.212.2424552 - Tlx 24780 Maica V  
www.maica-ve.com - maica@telcel.net.ve

HEADQUARTERS

BONFIGLIOLI RIDUTTORI S.p.A.  
Via Giovanni XXIII, 7/A  
40012 Lippo di Calderara di Reno  
Bologna (ITALY)  
Tel. (+39) 051 6473111  
Fax (+39) 051 6473126  
www.bonfiglioli.com  
bonfiglioli@bonfiglioli.com

SPARE PARTS BONFIGLIOLI

B.R.T.  
Via Castagnini, 2-4  
Z.I. Bargellino - 40012  
Calderara di Reno - Bologna (ITALY)  
Tel. (+39) 051 727844  
Fax (+39) 051 727066  
www.brtonbonfiglioliricambi.it  
brt@bonfiglioli.com

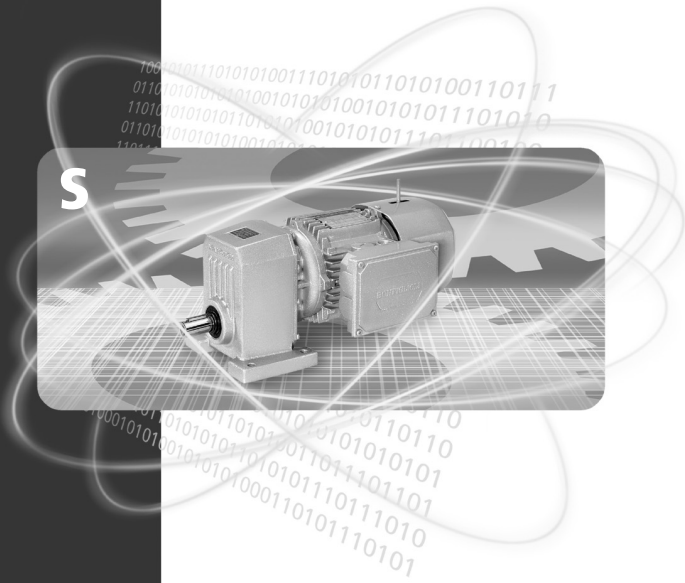

[www.bonfiglioli.com](http://www.bonfiglioli.com)

