

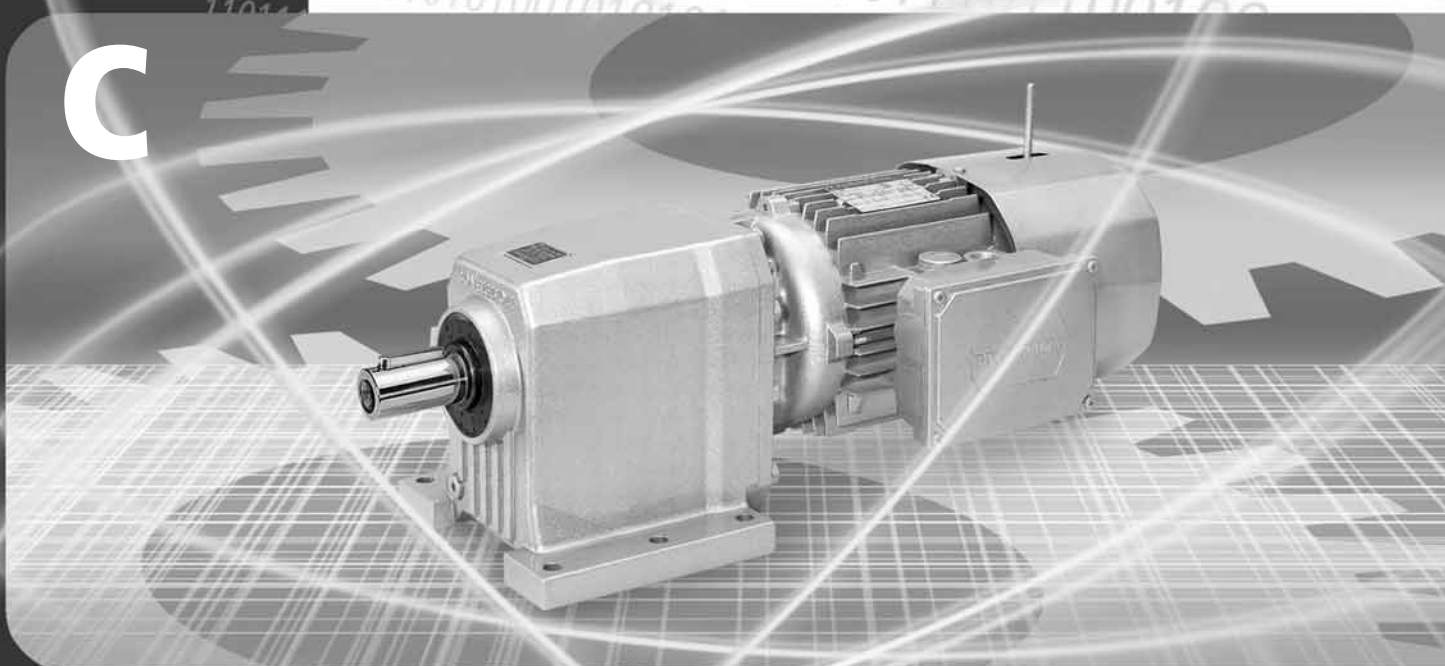











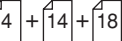

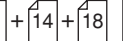

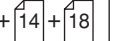







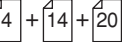

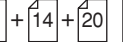

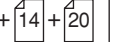







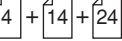

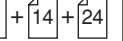

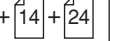







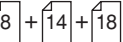





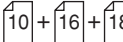

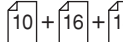



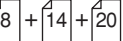

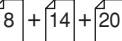

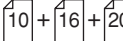

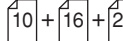















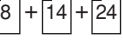

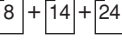

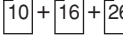

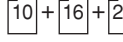





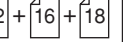

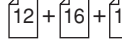



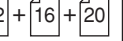

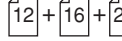

*Lista parti di ricambio - Spare parts list - Ersatzteilliste
Liste des pieces detachees - Lista de partes de recambio*

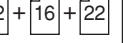
C

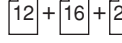

INPUT	C 05 2	C 11 2	C 21 2	C 21 3	C 31 2	C 31 3	C 35 2	C 35 3	C 35 4	C 41 2	C 41 3	C 41 4
 S05 ... S5												
 P(IEC)												
 HS												

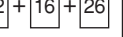
INPUT	C 51 2	C 51 3	C 51 4	C 61 2	C 61 3	C 61 4	C 70 2	C 70 3	C 70 4	C 80 2	C 80 3	C 80 4
 S05 ... S5												
 P63 ... P132												
 P160 ... P280												
 HS												

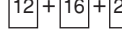





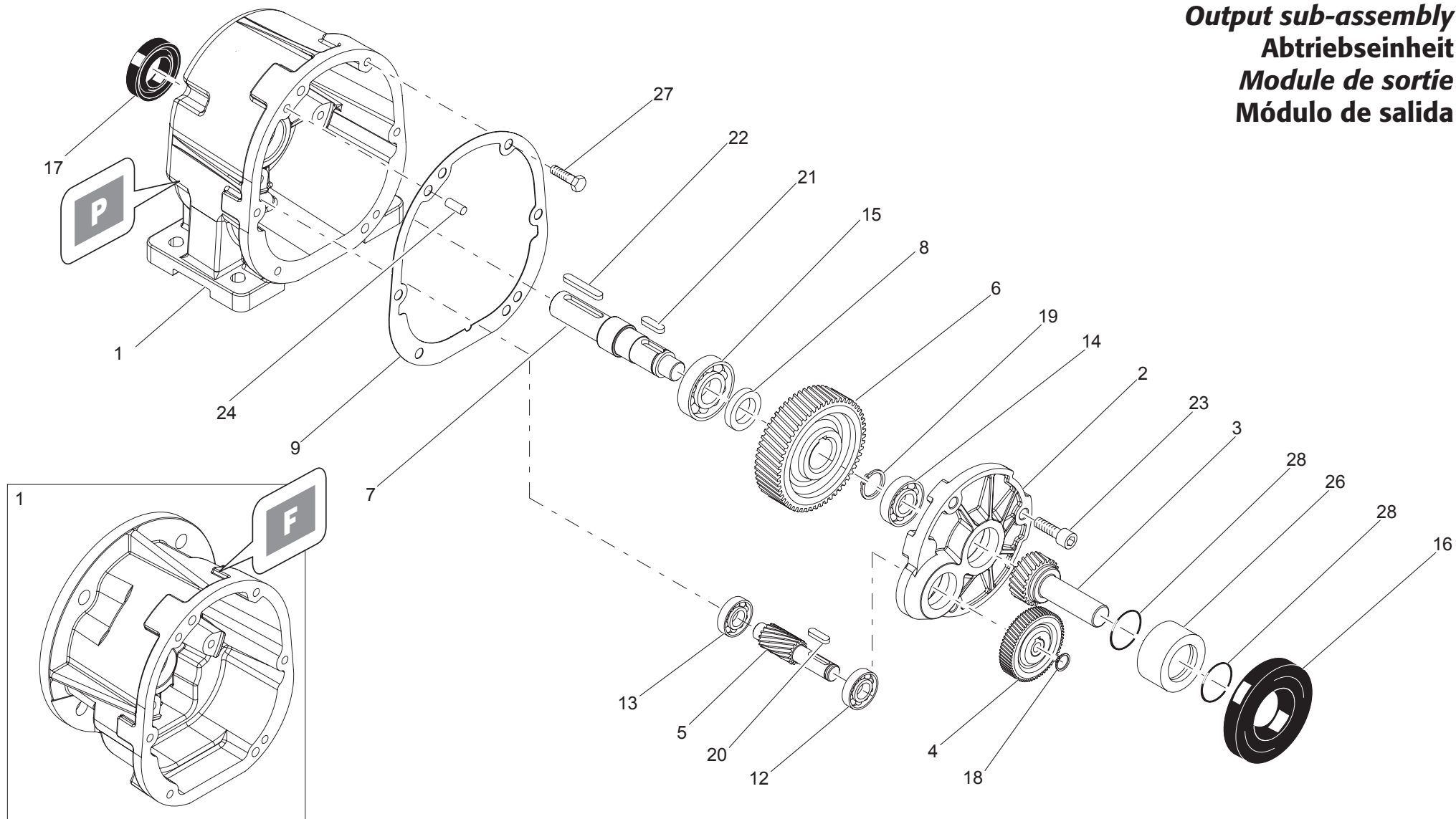

INPUT	C 90 2	C 90 3	C 90 4	C 100 2	C 100 3	C 100 4
 S05 ... S5						
 P63 ... P132						
 P160 ... P280						
 HS						

Quadro d'unione delle tavole parti di ricambio
Index of spare parts tables
Inhaltsverzeichnis Ersatzteillisten
Index des tables de pièces de rechange
Índice de la tabla de partes de recambio

Modulo uscita
Output sub-assembly
Abtriebseinheit
Module de sortie
Módulo de salida

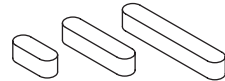

Pos.	Descrizione	Description	Benennung	Description	Descripción
1	Cassa	Housing	Gehäuse	Carter	Caja
2	Supporto interno	Connection flange	Verbindungsflansh	Couvercle de liaison	Brida de union
3	Pignone	Pinion gear	Ritzel	Pignon	Piñon
4	Corona	Gear	Zahnrad	Couronne	Corona
5	Pignone	Pinion gear	Ritzel	Pignon	Piñon
6	Corona	Gear	Zahnrad	Couronne	Corona
7	Albero lento	Output shaft	Abtriebswelle	Arbre de sortie	Eje de salida
9	Guarnizione cassa	Gasket	Dichtung	Joint plat	Junta

																	
	12	13	14	15	8	16	17	18	19	20	21	22	24	26	23	27	OR 28
C 05	6200	6000	6201	6003	28x17.5x3.5	35x47x7 L i = 5.5 ... 6.7 25x47x7 L i = 9.3 ... 12.5 20x47x7 L i = 15.6 ... 21.0 15x30x7 L i = 27.1 ... 44.7	20x30x7 DL	10	16	4x4x12 B	5x5x12 B	5x5x30 A	6x16 B	20x35	T.C.E.I. M6x25	T.E. M6x20	2018





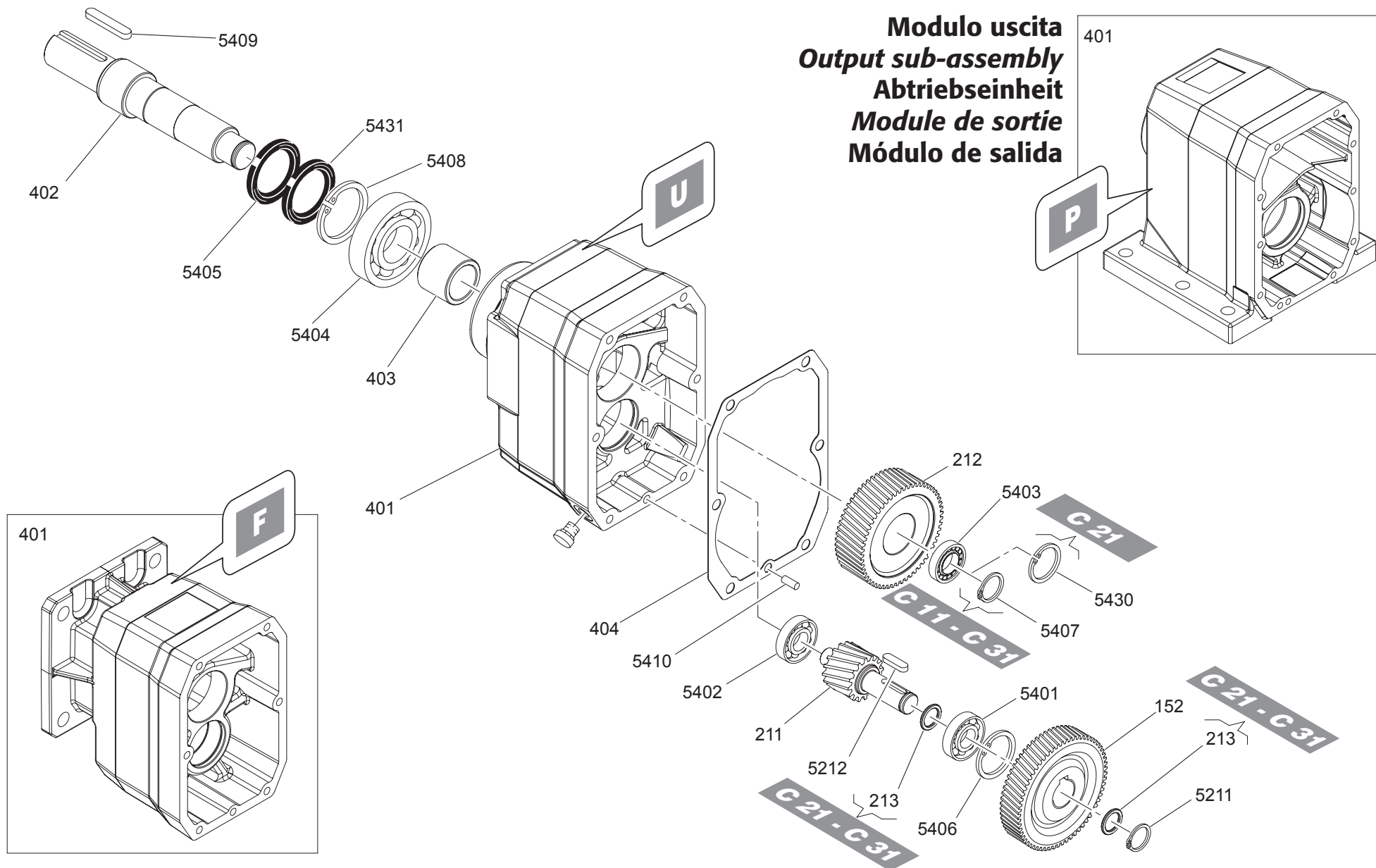

C 11

C 21

C 31



Pos.	Descrizione	Description	Benennung	Description	Descripción
152	Corona veloce	Gear	Zahnrad	Couronne	Corona
211	Pignone lento	Pinion gear	Ritzel	Pignon	Piñon
212	Corona lenta	Gear	Zahnrad	Couronne	Corona
213	Spessore	Spacer	Distanzring	Entretoise	Distanciador
401	Cassa	Housing	Gehäuse	Carter	Caja
402	Albero lento	Output shaft	Abtriebswelle	Arbre de sortie	Eje de salida
403	Distanziale	Spacer ring	Distanzring	Entretoise	Distanciador
404	Guarnizione	Gasket	Dichtung	Jointplat	Junta

															
	5401	5402	5403	5404	5410	5212	5409	5211	5407	5406	5408	5430	5405	5431	
C 11	6201	6200	6202	6204	5x16	4x4x16 C	6x6x30 A	12	15	32	47		25x47x7 DL	25x47x7 L	
C 21	6302	6301	NJ202E	6206	5x16	5x5x17 C	8x7x40 A	15		42	62		35x62x7 DL	35x65x7 L	
C 31	6303	6302	NUP2203E	6207	6x16	5x5x19 C	8x7x50 A	17	17	47	72	35	40x72x7 DL	40x72x7 L	





C 35

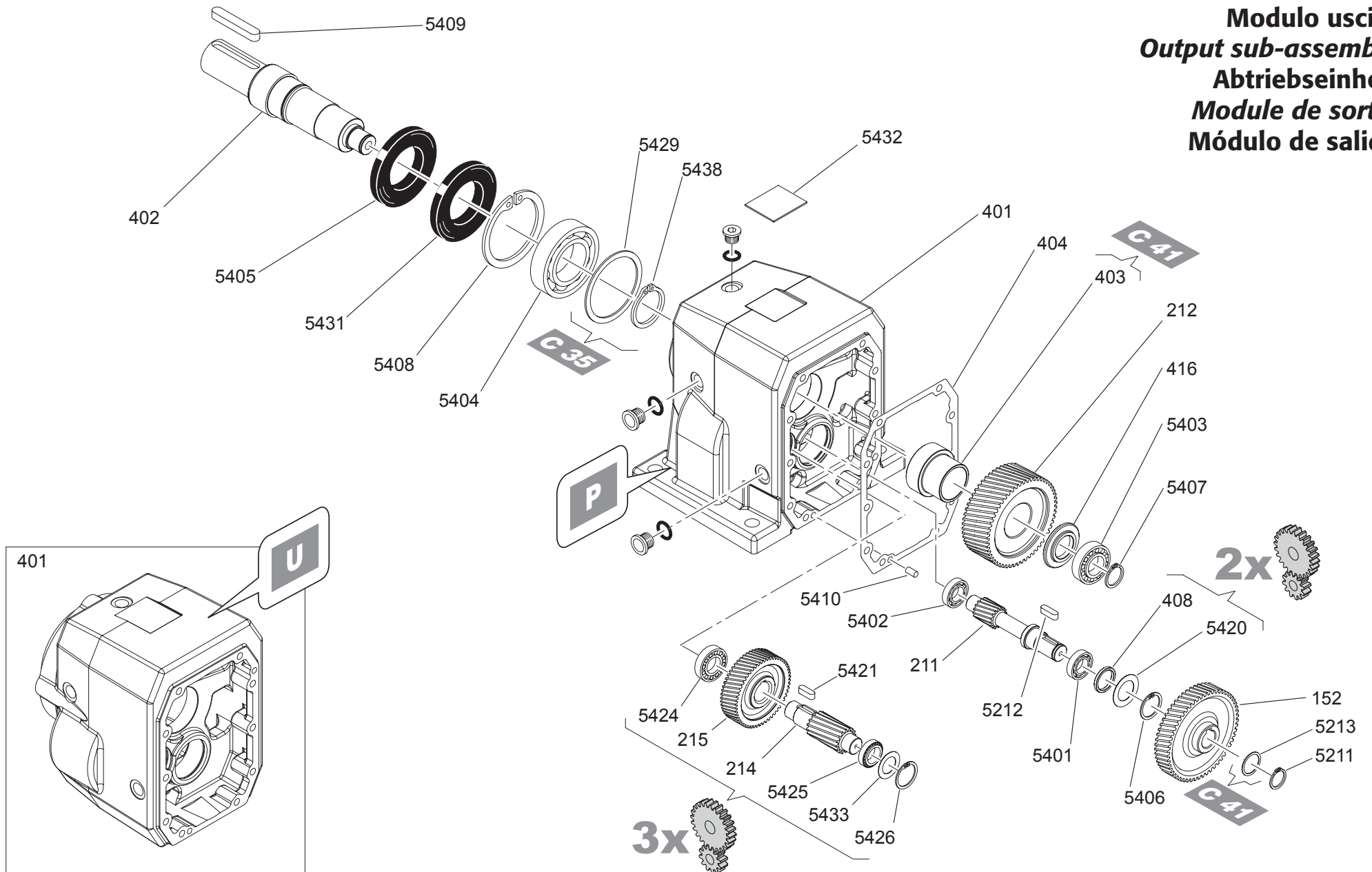

C 41

Modulo uscita
Output sub-assembly
Abtriebseinheit
Module de sortie
Módulo de salida



Pos.	Descrizione	Description	Benennung	Description	Descripción
152	Pignone	Pinion gear	Ritzel	Pignon	Piñon
211	Pignone	Pinion gear	Ritzel	Pignon	Piñon
212	Corona lenta	Gear	Zahnrad	Couronne	Corona
214	Pignone	Pinion gear	Ritzel	Pignon	Piñon
215	Corona	Gear	Zahnrad	Couronne	Corona
401	Cassa	Housing	Gehäuse	Carter	Caja
402	Albero lento	Output shaft	Abtriebswelle	Arbre de sortie	Eje de salida
403	Distanziale albero lento	Spacer ring	Distanzring	Entretoise	Distanciador
404	Guarnizione cassa	Gasket	Dichtung	Joint plat	Junta
407	Distanziale pignone	Spacer ring	Distanzring	Entretoise	Distanciador
408	Distanziale pignone	Spacer ring	Distanzring	Entretoise	Distanciador
416	Distanziale albero lento	Spacer ring	Distanzring	Entretoise	Distanciador





												
	5401	5402	5403	5404	5424	5425	5405	5431	5410	5212	5409	5421
C 35 2	32004	30302	NUP 204 EC	6208 (*)			45x80x10	45x80x8 L	6x16	6x6x19 C	10x8x60 A	
C 35 3 C 35 4	6004	6302	NUP 204 EC	6208 (*)	30203	30203	45x80x10	45x80x8 L	6x16	5x5x19 C	10x8x60 A	6x6x19 C
C 41 2	6204 ETN9 30204 i = 2.7...6.0	6303 30204	NUP 205 EC	6209 (*)			50x85x10	50x85x10 L	6x16	6x6x25 C	10x8x60 A	
C 41 3 C 41 4	6204	6303	NUP 205 EC	6209 (*)	30203	30203	50x85x10	50x85x10 L	6x16	6x6x25 C	10x8x60 A	8x7x19 C

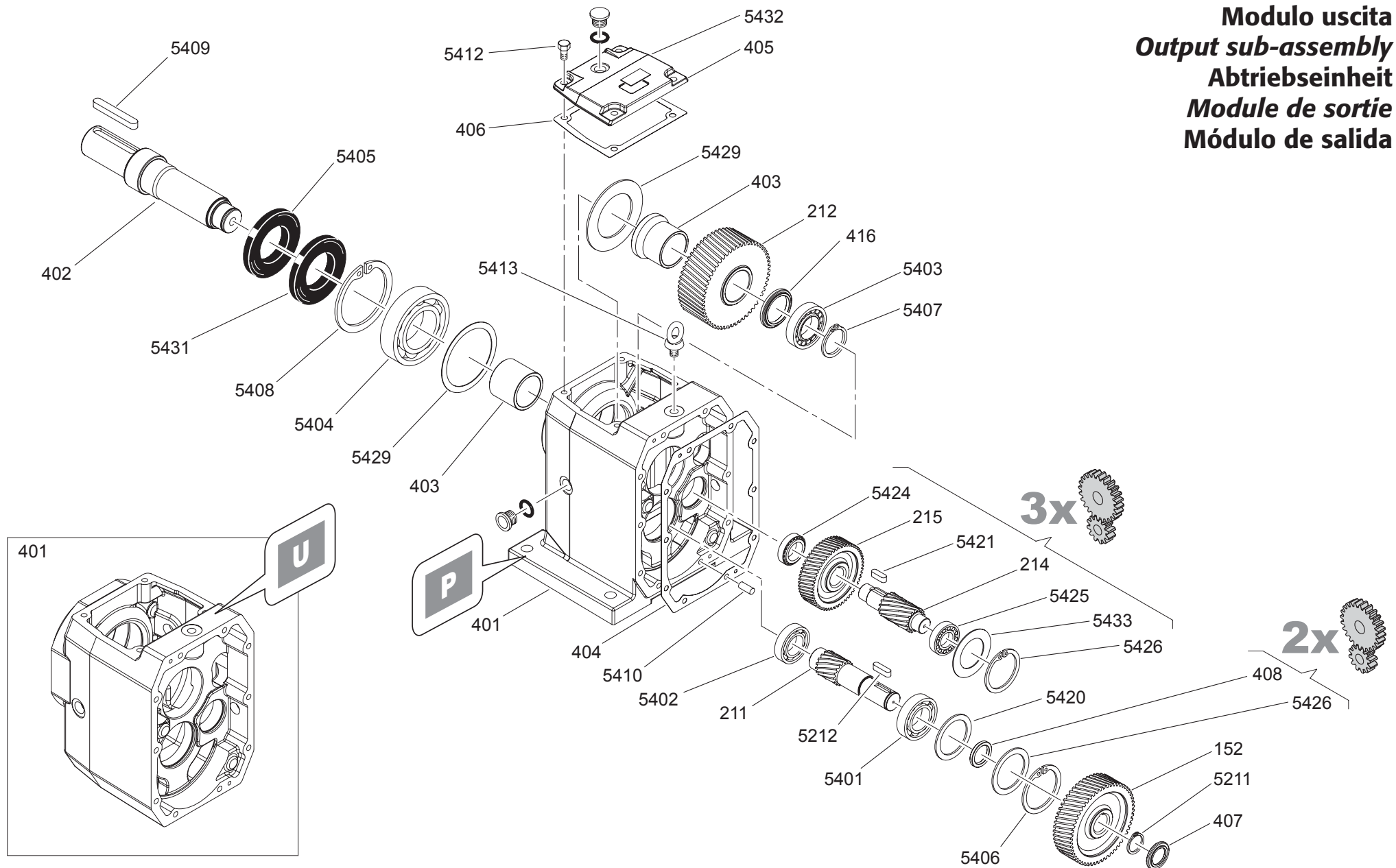





											
	5211	5407	5438	5406	5408	5426	5213	5429	5402	5433	
C 35 2	20	20	40	42	80			LMKAS 80	30x42x1,5 R		
C 35 3 C 35 4	17	20	40	42	80	40		LMKAS 80		34x40x1 R	
C 41 2	20	25		47	85		20.2x27.8x1 R		37x47x1 R		
C 41 3 C 41 4	20	25		47	85	42	20.2x27.8x1 R			30x42x2 R	

(*) Cuscinetto tipo 2RS per posizioni di montaggio verticali / Bearing type 2RS for vertical mounting positions / Lager Typ 2RS für senkrechten Einbaulagen
Roulement type 2RS pour positions de montage verticaux / Rodamiento tipo 2RS para posiciones de montaje verticales



Pos.	Descrizione	Description	Benennung	Description	Descripción
152	Corona	Gear	Zahnrad	Couronne	Corona
211	Pignone	Pinion gear	Ritzel	Pignon	Piñon
212	Corona	Gear	Zahnrad	Couronne	Corona
214	Pignone	Pinion gear	Ritzel	Pignon	Piñon
215	Corona	Gear	Zahnrad	Couronne	Corona
401	Cassa	Housing	Gehäuse	Carter	Caja
402	Albero lento	Output shaft	Abtriebswelle	Arbre de sortie	Eje de salida
403	Distanziale albero lento	Spacer ring	Distanzring	Entretoise	Distanciador
404	Guarnizione cassa	Gasket	Dichtung	Jointplat	Junta
405	Coperchio di ispezione	Inspection cover	Inspektionsdeckel	Couvercle d'inspection	Tapa de inspección
406	Guarnizione coperchio	Gasket	Dichtung	Jointplat	Junta
407	Distanziale pignone	Spacer ring	Distanzring	Entretoise	Distanciador
408	Distanziale pignone	Spacer ring	Distanzring	Entretoise	Distanciador
416	Distanziale albero lento	Spacer ring	Distanzring	Entretoise	Distanciador

												
	5401	5402	5403	5404	5424	5425	5405	5431	5410	5212	5409	5421
C 51 2	6305 ETN9 30305 i = 2.6...5.6	6305 30206 i = 2.6...5.6	NUP 206	6309 (*)			55x100x10 DL	55x100x10 DL	6x16	8x7x25 B	12x8x70 A	
C 51 3 C 51 4	6305	6403	NUP 206	6309 (*)	30204	32303	55x100x10 DL	55x100x10 DL	6x16	8x7x25 B	12x8x70 A	8x7x22 A
C 61 2	30306	30207	NUP 208	6311 (*)			65x120x13 DL	65x120x10 L	6x16	8x7x30 B	14x9x90 A	
C 61 3 C 61 4	6306	6404	NUP 208	6311 (*)	30205	32304	65x120x13 DL	65x120x10 L	6x16	8x7x30 C	14x9x90 A	8x7x26 C

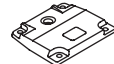



												
	5211	5407	5406	5408	5426	5420	5433	5434	5429	5412	5413	5432
C 51 2	25	30	62	100		50x62x2 R		25x35x2 R	LMKAS 100	T.C.E.I. M10x25	12x8x70 A	
C 51 3 C 51 4	25	30	62	100	47		37x57x1 R	25x35x2 R	LMKAS 100	T.C.E.I. M10x25	12x8x70 A	8x7x22 A
C 61 2	30	40	72	120		56x72x3 R			LMKAS 120	T.E. M10x25	14x9x90 A	
C 61 3 C 61 4	30	40	72	120	52		42x52x1 P		LMKAS 120	T.E. M10x25	14x9x90 A	8x7x26 C

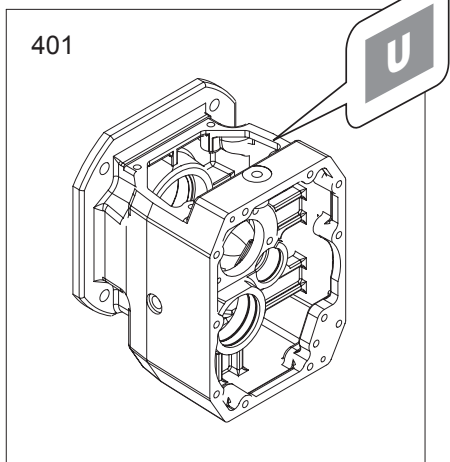
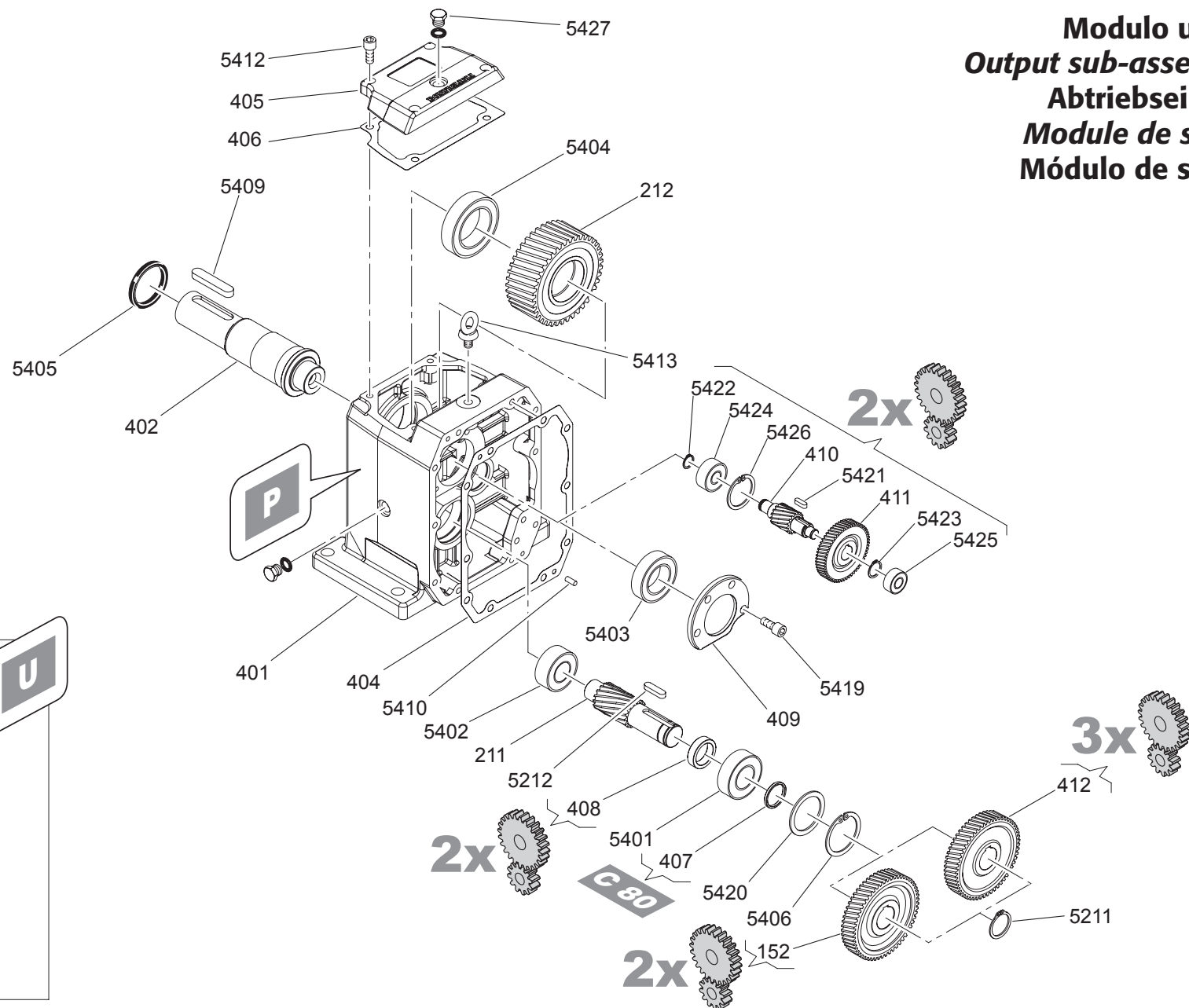



(*) Cuscinetto tipo 2RS per posizioni di montaggio verticali / Bearing type 2RS for vertical mounting positions / Lager Typ 2RS für senkrechten Einbaulagen
Roulement type 2RS pour positions de montage verticaux / Rodamiento tipo 2RS para posiciones de montaje verticales

Modulo uscita
Output sub-assembly
Abtriebseinheit
Module de sortie
Módulo de salida



Pos.	Descrizione	Description	Benennung	Description	Descripción
152	Corona veloce	<i>Gear</i>	Zahnrad	<i>Couronne</i>	Corona
211	Pignone lento	<i>Pinion gear</i>	Ritzel	<i>Pignon</i>	Piñon
212	Corona lenta	<i>Gear</i>	Zahnrad	<i>Couronne</i>	Corona
401	Cassa	<i>Housing</i>	Gehäuse	<i>Carter</i>	Caja
402	Albero lento	<i>Output shaft</i>	Abtriebswelle	<i>Arbre de sortie</i>	Eje de salida
404	Guarnizione	<i>Gasket</i>	Dichtung	<i>Jointplat</i>	Junta
405	Coperchio d'ispezione	<i>Inspection cover</i>	Inspektionsdeckel	<i>Couvercle d'inspection</i>	Tapa de inspección
406	Guarnizione coperchio	<i>Gasket</i>	Dichtung	<i>Jointplat</i>	Junta
407	Distanziale	<i>Spacer ring</i>	Distanzring	<i>Entretoise</i>	Distanciadore
408	Distanziale	<i>Spacer ring</i>	Distanzring	<i>Entretoise</i>	Distanciadore
409	Anello per cuscinetto	<i>Bearing retainer</i>	Schlußring	<i>Bague de fermeture</i>	Anillo de tope para rodamiento
410	Pignone	<i>Pinion gear</i>	Ritzel	<i>Pignon</i>	Piñon
411	Corona	<i>Gear</i>	Zahnrad	<i>Couronne</i>	Corona
412	Corona	<i>Gear</i>	Zahnrad	<i>Couronne</i>	Corona





											
	5401	5402	5403	5404	5424	5425	5405	5413	5212	5409	5421
C 70 2	32208	33207	33110	33014			70x95x10 L	M16	12x8x45 B	18x11x90 A	
C 70 3 C 70 4	32208	33207	33110	33014	4304	NJ2203E	70x95x10 L	M16	12x8x45 B	18x11x90 A	8x7x25 C
C 80 2	32210	32308	33112	33017			85x110x12 L	M20	14x9x50 B	22x14x110 A	
C 80 3 C 80 4	32210	32308	33112	33017	4305	NJ2205	85x110x12 L	M20	14x9x50 B	22x14x110 A	8x7x30 C

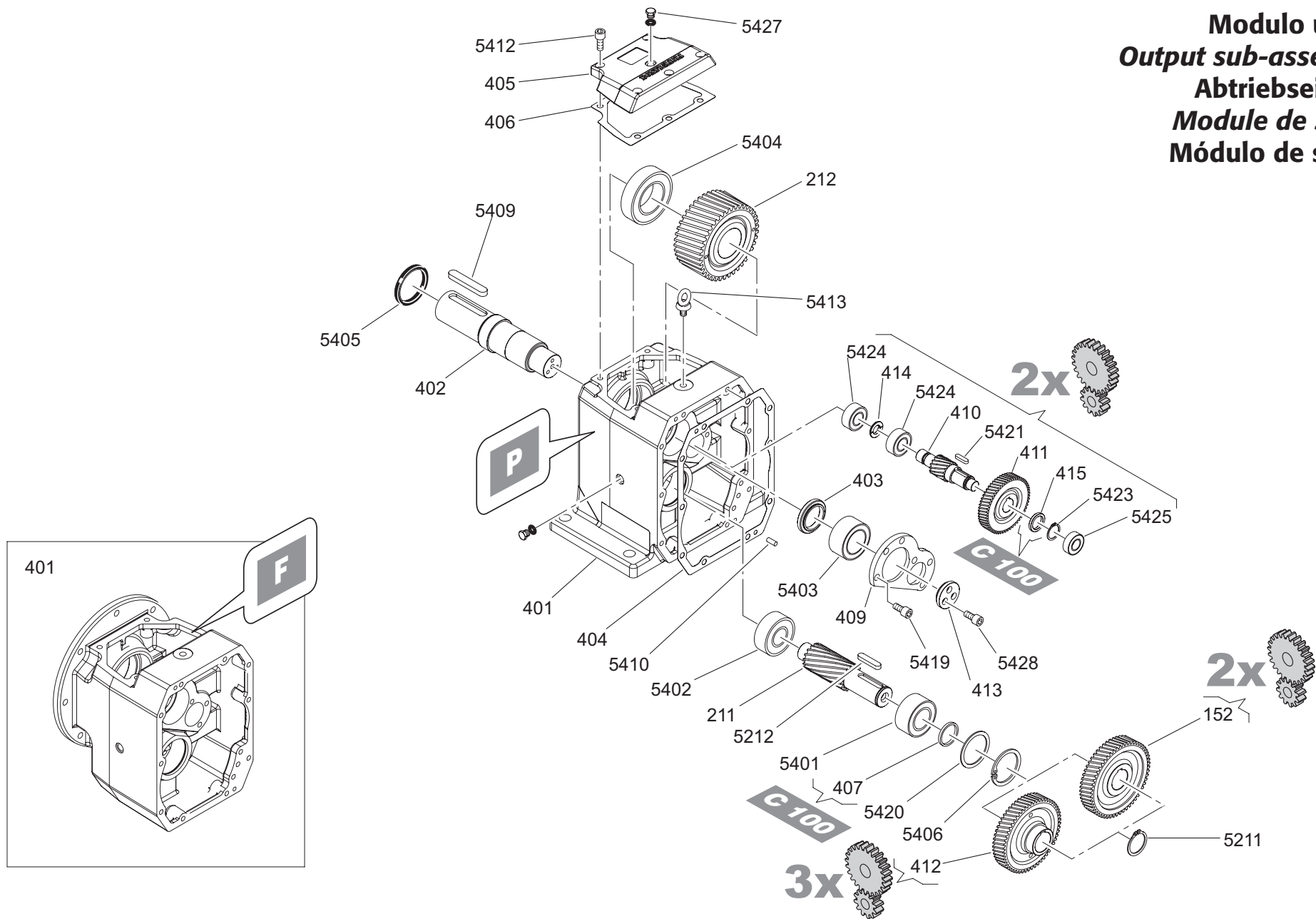



									
	5221	5422	5423	5406	5426	5420	5412	5419	5410
C 70 2	40			80		"R" 68x80x3	T.C.E.I. M12x30 T.C.E.I. M12x40	T.C.E.I. M12x30	8x20
C 70 3 C 70 4	40	20	25	80	52	"R" 68x80x3	T.C.E.I. M12x30 T.C.E.I. M12x40	T.C.E.I. M12x30	8x20
C 80 2	50			90		"R" 70x90x3.5	T.C.E.I. M12x30 T.C.E.I. M12x45	T.C.E.I. M12x30	8x20
C 80 3 C 80 4	50	25	30	90	62	"R" 70x90x3.5	T.C.E.I. M12x30 T.C.E.I. M12x45	T.C.E.I. M12x30	8x20

Modulo uscita
Output sub-assembly
Abtriebseinheit
Module de sortie
Módulo de salida



Pos.	Descrizione	Description	Benennung	Description	Descripción
152	Corona	Gear	Zahnrad	Couronne	Corona
211	Pignone	Pinion gear	Ritzel	Pignon	Piñon
212	Corona	Gear	Zahnrad	Couronne	Corona
401	Cassa	Housing	Gehäuse	Carter	Caja
402	Albero lento	Output shaft	Abtriebswelle	Arbre de sortie	Eje de salida
403	Distanziale	Spacer ring	Distanzring	Entretoise	Distanciador
404	Guarnizione	Gasket	Dichtung	Jointplat	Junta
405	Coperchio di ispezione	Inspection cover	Inspektionsdeckel	Couvercle d'inspection	Tapa de inspección
406	Guarnizione	Gasket	Dichtung	Jointplat	Junta
407	Distanziale	Spacer ring	Distanzring	Entretoise	Distanciador
409	Piastra di arresto cuscinetto	Bearing retainer	Ring für Lager	Bague pour roulement	Chapa de fijación de rodamiento
410	Pignone	Pinion gear	Ritzel	Pignon	Piñon
411	Corona	Gear	Zahnrad	Couronne	Corona
412	Corona	Gear	Zahnrad	Couronne	Corona
413	Golfare	Eyebolt	Ösenschraube	Cheville à oeillet	Perno de argolla
414	Boccola	Bushing	Buchse	Douille	Casquillo
415	Distanziale	Spacer ring	Distanzring	Entretoise	Distanciador

											
	5404	5403	5402	5401	5424	5425	5405	5413	5409	5212	5421
C 90 2	NJ2218	32014X	T2ED050	33212			100x130x12 L	M20	25x14x140 A	18x11x82 C	
C 90 3 C 90 4	NJ2218	32014X	T2ED050	33212	33207	NJ2206	100x130x12 L	M20	25x14x140 A	18x11x82 C	12x8x45 C
C 100 2	NJ2220	32016X	32312	33215			115x150x12 L	M24	28x16x180 A	20x12x90 C	
C 100 3 C 100 4	NJ2220	32016X	32312	33215	33210	NJ2306	115x150x12 L	M24	28x16x180 A	20x12x90 C	14x9x50 C

								
	5211	5423	5406	5420	5412	5419	5428	5410
C 90 2	60	40	110	"R" 90x110x3.5	T.C.E.I. M16x40 T.C.E.I. M16x55	T.C.E.I. M16x35	T.C.E.I. M12x30	12x30
C 90 3 C 90 4	60	40	110	"R" 90x110x3.5	T.C.E.I. M16x40 T.C.E.I. M16x55	T.C.E.I. M16x35	T.C.E.I. M12x30	12x30
C 100 2	72	50	130	"R" 105x130x3.5	T.C.E.I. M16x40 T.C.E.I. M16x60	T.C.E.I. M16x40	T.C.E.I. M12x30	14x35
C 100 3 C 100 4	72	50	130	"R" 105x130x3.5	T.C.E.I. M16x40 T.C.E.I. M16x60	T.C.E.I. M16x40	T.C.E.I. M12x30	14x35

C 21 3

C 31 3

C 35 4

C 41 4





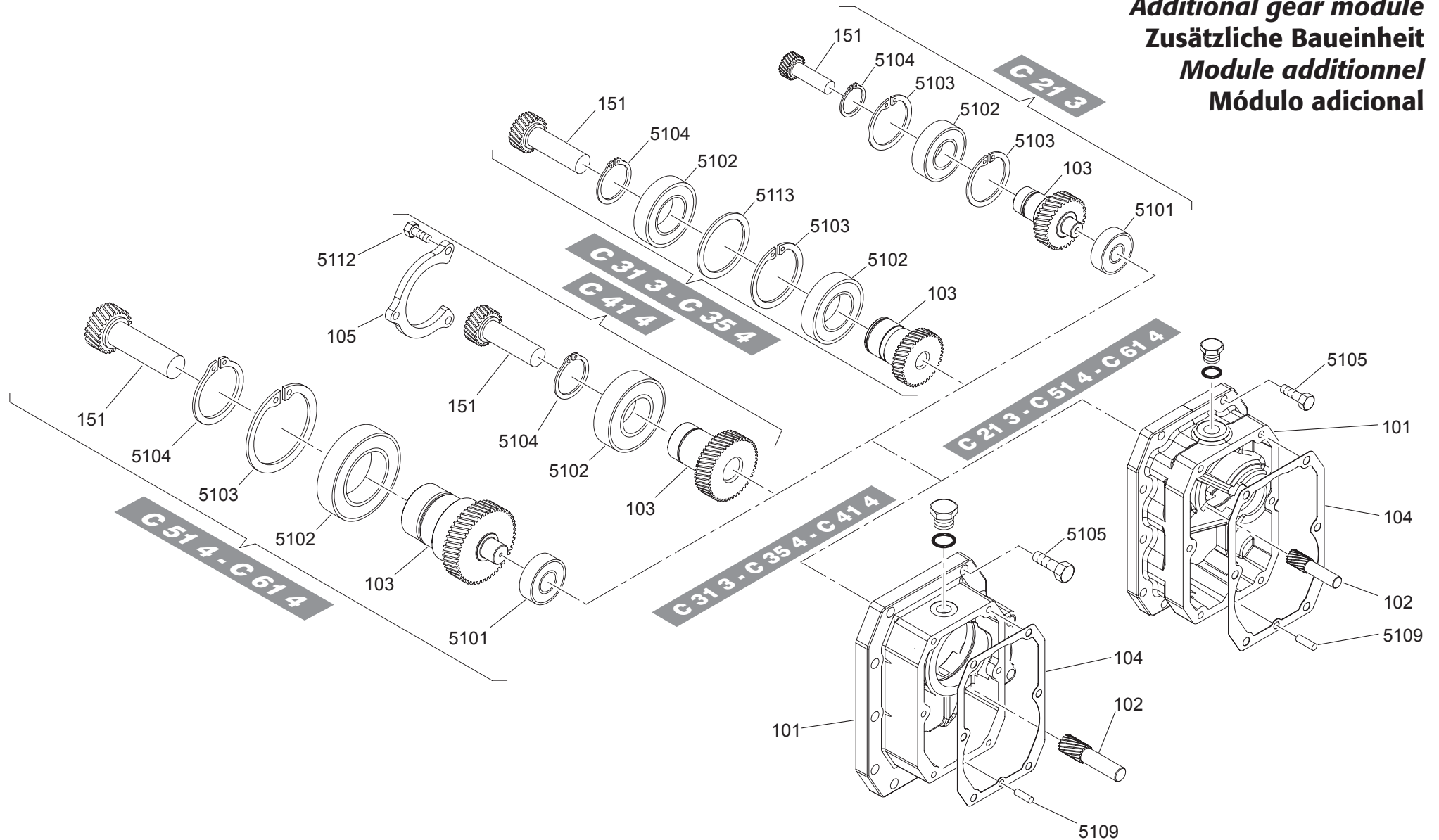

C 51 4

C 61 4

Modulo addizionale
Additional gear module
Zusätzliche Baueinheit
Module additionnel
Módulo adicional







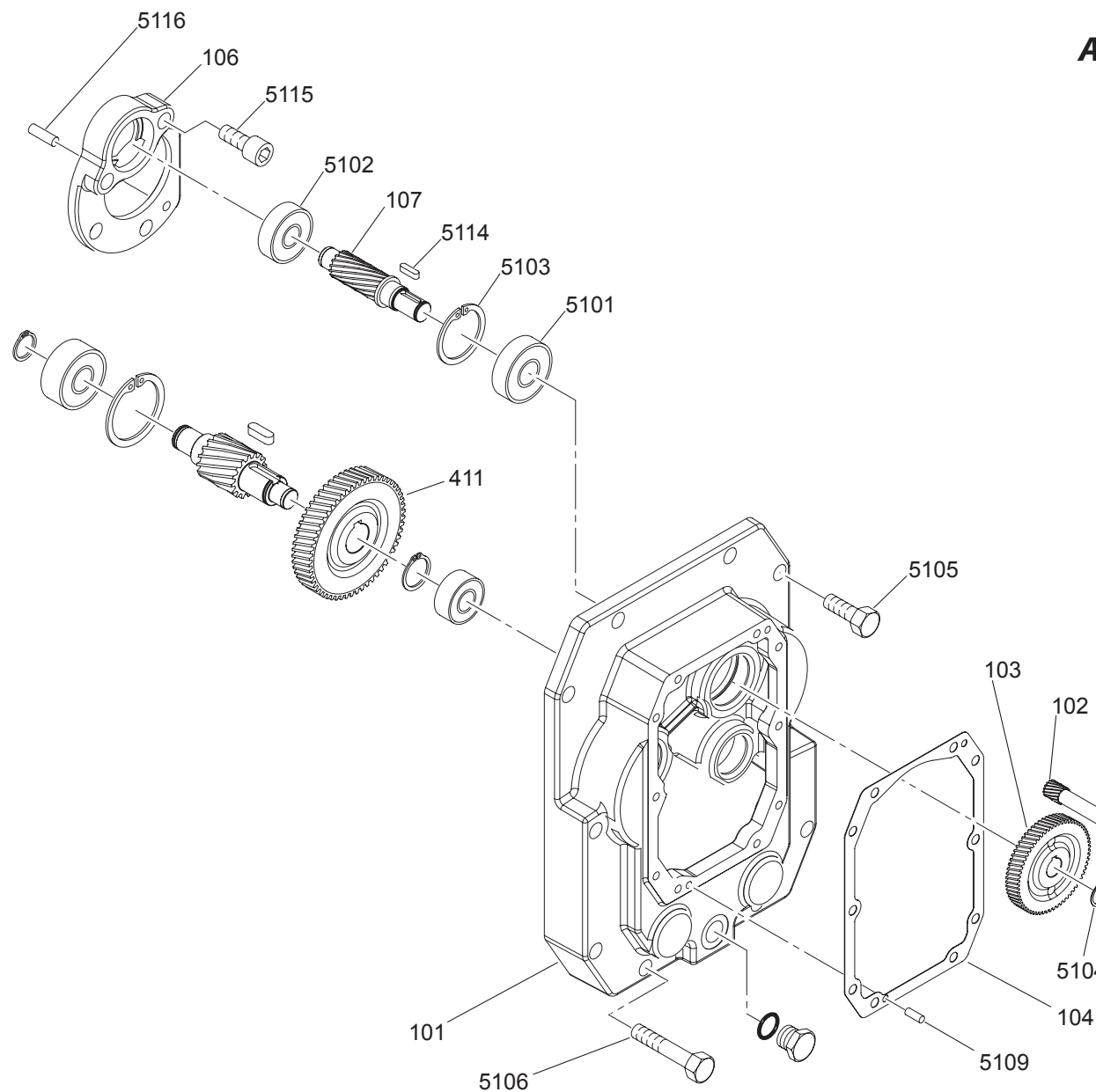

Pos.	Descrizione	Description	Benennung	Description	Descripción
101	Modulo addizionale	Additional gear module	Zusätzliche Baueinheit	Module additionnel	Módulo adicional
102	Pignone	Pinion gear	Ritzel	Pignon	Piñon
103	Corona	Gear	Zahnrad	Couronne	Corona
104	Guarnizione	Gasket	Dichtung	Jointplat	Junta
105	Anello di battuta per cuscinetto	Bearing retainer	Schlußring	Bague de fermeture	Anillo de tope para rodamiento
151	Pignone	Pinion gear	Ritzel	Pignon	Piñon

								
	5101	5102	5104	5103	5109	5105	5112	5113
C 21 3	6201 2Z	6004	20	42	5x16	T.C.E. M6x20 T.C.E. M6x50		
C 31 3 - C 35 4		6006	30	55	5x16	T.C.E. M8x25 T.C.E. M8x60		45x55x2 "R"
C 41 4		3206-2RS	30		5x16	T.E. M8x25 T.E. M8x65	T.E. M6x16	
C 51 4	NJ202	6008	40	68	6x16	T.E. M10x35 T.E. M10x75		
C 61 4	NJ203	6010	50	80	6x16	T.E. M10x35 T.E. M10x80		

Modulo addizionale
Additional gear module
Zusätzliche Baueinheit
Module additionnel
Módulo adicional



Pos.	Descrizione	Description	Benennung	Description	Descripción
101	Modulo addizionale	Additional gear module	Zusätzliche Baueinheit	Module additionnel	Módulo adicional
102	Pignone	Pinion gear	Ritzel	Pignon	Piñon
103	Corona	Gear	Zahnrad	Couronne	Corona
104	Guarnizione	Gasket	Dichtung	Jointplat	Junta
107	Pignone	Pinion gear	Ritzel	Pignon	Piñon
106	Supporto per cuscinetto	Bearing support	Lageraufnahme	Support roulement	Soporte para rodamiento
411	Corona	Gear	Zahnrad	Couronne	Corona

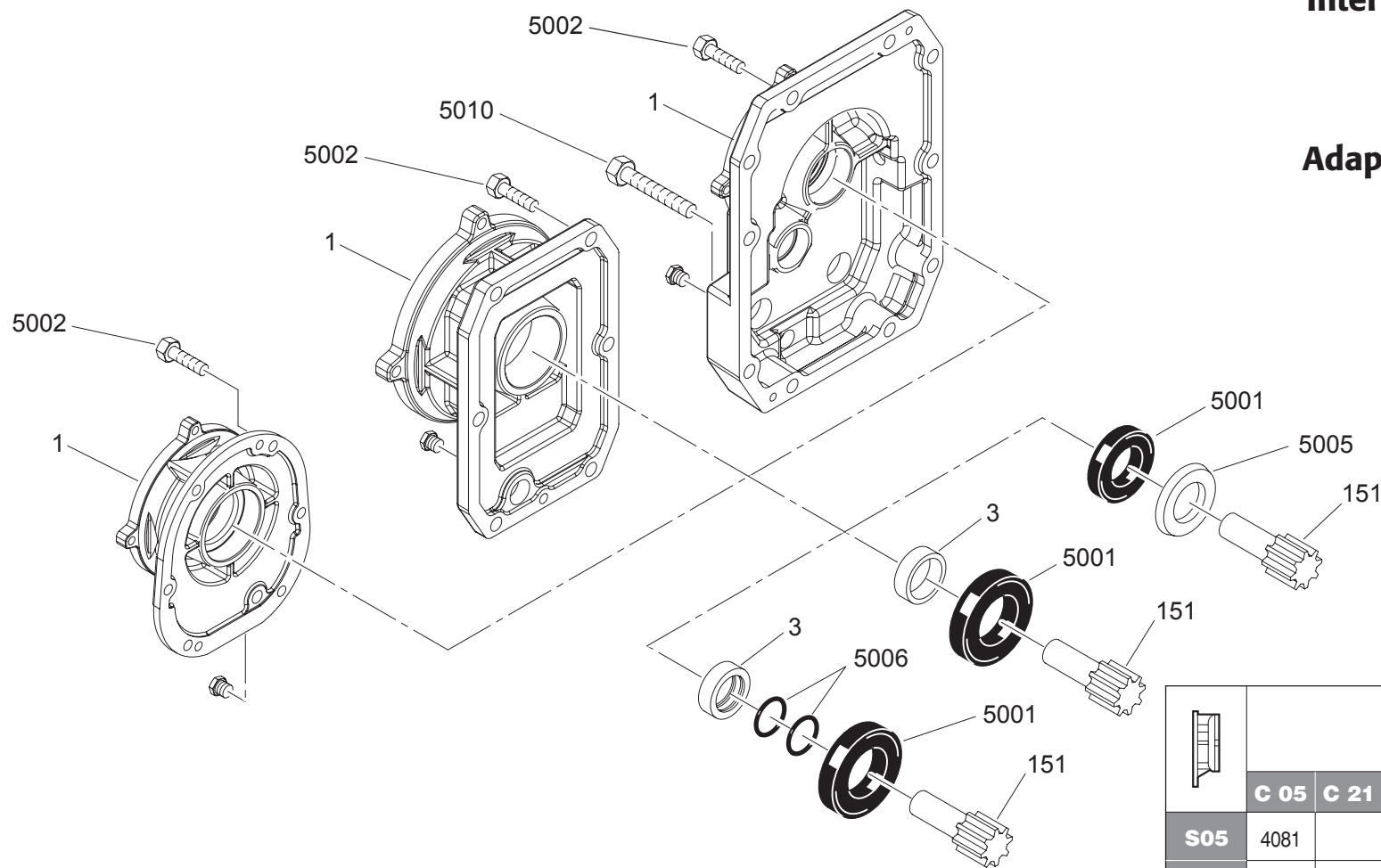

										
	5101	5102	5114	5105	5106	5115	5104	5103	5109	51156
C 70	6304	6303	5x5x19 C	T.E. M12x35	T.E. M12x65	T.C.E.I. M12x30 T.C.E.I. M12x40	17	52	6x16	8x26
C 80	6404	6304	6x6x25 C	T.E. M12x35	T.E. M12x65	T.C.E.I. M12x30	20	72	6x16	8x30
C 90	6306	6305	8x7x25 C	T.E. M16x50	T.E. M16x80	T.C.E.I. M16x35	25	72	6x16	
C 100	6406	6306	8x7x30 C	T.E. M16x55		T.C.E.I. M16x45	30	90	6x16	

Interfaccia per motore compatto
Compact motor interface
S Baueinheit
Module S
Adaptador para motor compacto



	OR 5006				
	C 05	C 21 - C 31	C 35 ... C 51	C 61 ... C 90	C 100
S05	4081				
S1	4081				
S2					
S3		4137	4137	4137	
S4			149	149	149
S5				149	149

Pos.	Descrizione	Description	Benennung	Description	Descripción
1	Coperchio	Cover	Deckel	Couvercle	Tapa
3	Boccola	Bushing	Buchse	Douille	Casquillo
151	Pignone	Pinion gear	Ritzel	Pignon	Piñon



	 5001								 5005						
	C 05	C 11	C 21	C 31	C 35 ... C 51	C 61 - C 70	C 80 - C 90	C 100	C 05	C 11 - C 21	C 31	C 35 - C 51	C 61 - C 70	C 80 - C 90	C 100
S05	20x47x7 L	20x35x7 L	20x35x7 L						20x35x4	20x35x4					
S1	20x47x7 L 35x47x7 L	20x35x7 L 25x35x7 L	20x35x7 L 25x35x7 L	20x35x7 L 25x35x7 L	20x35x7 L 25x35x7 L				20x35x4	20x35x4	20x35x4	20x35x4			
S2		35x55x8 L	35x55x8 L 42x55x8 L	35x55x8 L 42x55x8 L	35x55x8 L 42x55x8 L	35x55x8 L 42x55x8 L				35x52x4.5	35x52x4.5	35x52x4.5	35x52x4.5		
S3		35x62x7 L	35x62x7 L 48x62x8 L	35x62x7 L 48x62x8 L	35x62x7 L 48x62x8 L	35x62x7 L 48x62x8 L	35x62x7 L 48x62x8 L			35x52x4.5	35x52x4.5	35x52x4.5	35x52x4.5	35x52x4.5	
S4					45x85x10 L 65x85x10 L	45x85x10 L 65x85x10 L	45x85x10 L 65x85x10 L	45x85x10 L 65x85x10 L				45x62x4.5	45x62x4.5	45x62x4.5	45x62x4.5
S5						45x85x10 L 65x85x10 L	45x90x10 L 65x90x10 L	45x90x10 L 65x90x10 L					45x62x4.5	45x62x4.5	45x62x4.5

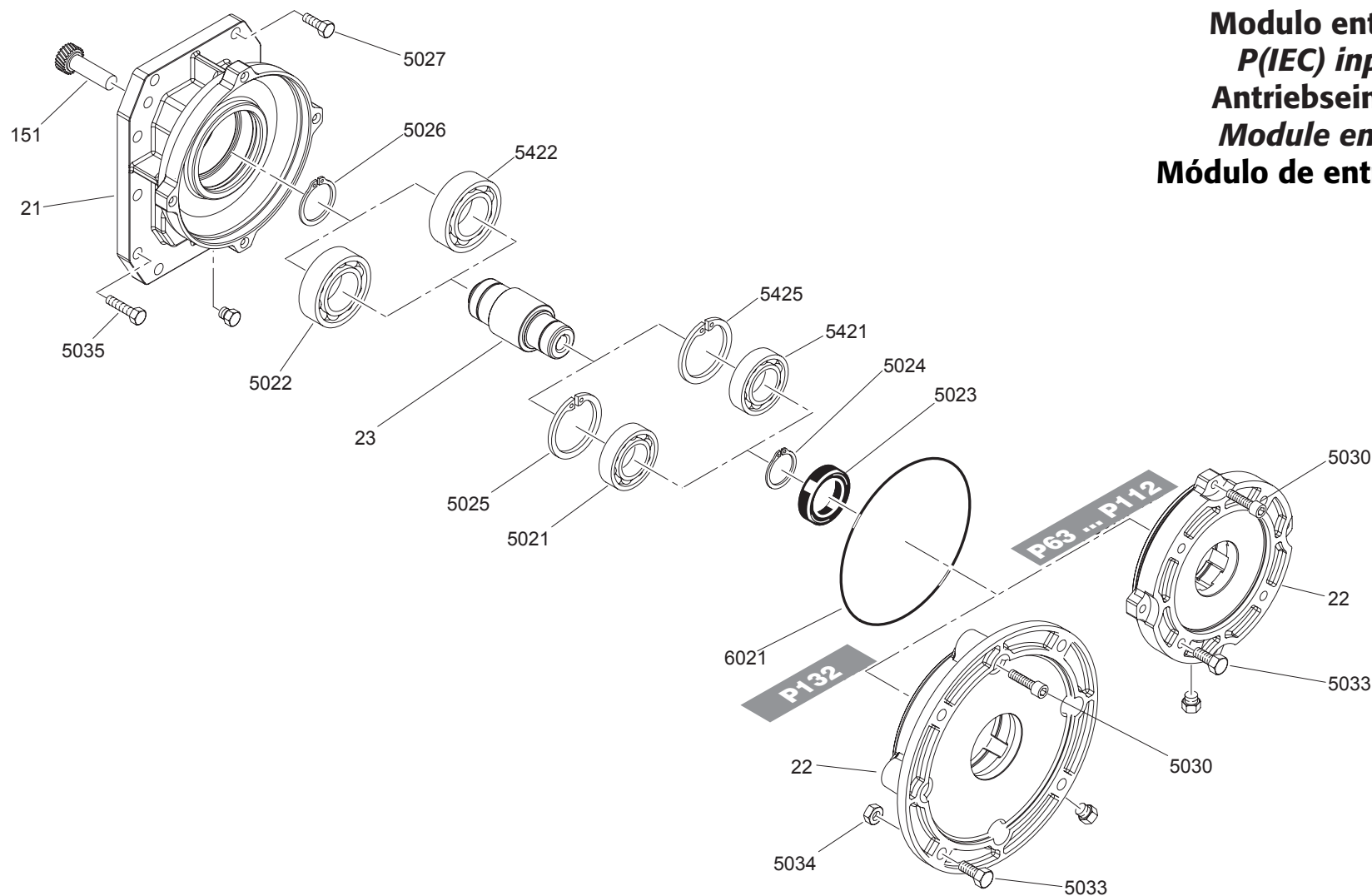



	 5002											5010		
	C 05	C 11	C 21	C 31	C 35 - C 41	C 51	C 61	C 70	C 80	C 90	C 100	C 70	C 80	C 90
S05	M6x20	M6x18 M6x20 M6x22	M6x20											
S1	M6x20	M6x20 M6x22	M6x16 M6x18 M6x20 M6x22	M8x25	M8x25	M10x25 M10x30								
S2		M6x20 M6x22	M6x20 M6x22	M8x25	M8x20 M8x25	M10x25 M10x30	M10x30	M12x35				M12x65		
S3		M6x20 M6x22	M6x20 M6x22	M8x25	M8x20 M8x25	M10x25 M10x30	M10x30	M12x35	M12x35	M16x50		M12x65	M12x65	M16x80
S4					M8x20 M8x25	M10x25 M10x30	M10x30	M12x35	M12x35	M16x50	M16x55	M12x65	M12x65	M16x80
S5							M10x30	M12x35	M12x35	M16x50	M16x55	M12x65	M12x65	M12x80



Modulo entrata P(IEC)
P(IEC) input module
Antriebseinheit P(IEC)
Module entree P(IEC)
Módulo de entrada P(IEC)

Pos.	Descrizione	Description	Benennung	Description	Descripción
21	Coperchio	Cover	Deckel	Couvercle	Tapa
22	Flangia	Flange	Flansch	Bride	Brida
23	Albero veloce	Input shaft	Antriebswelle	Arbre rapide	eje de salida
151	Pignone	Pinion gear	Ritzel	Pignon	Piñon







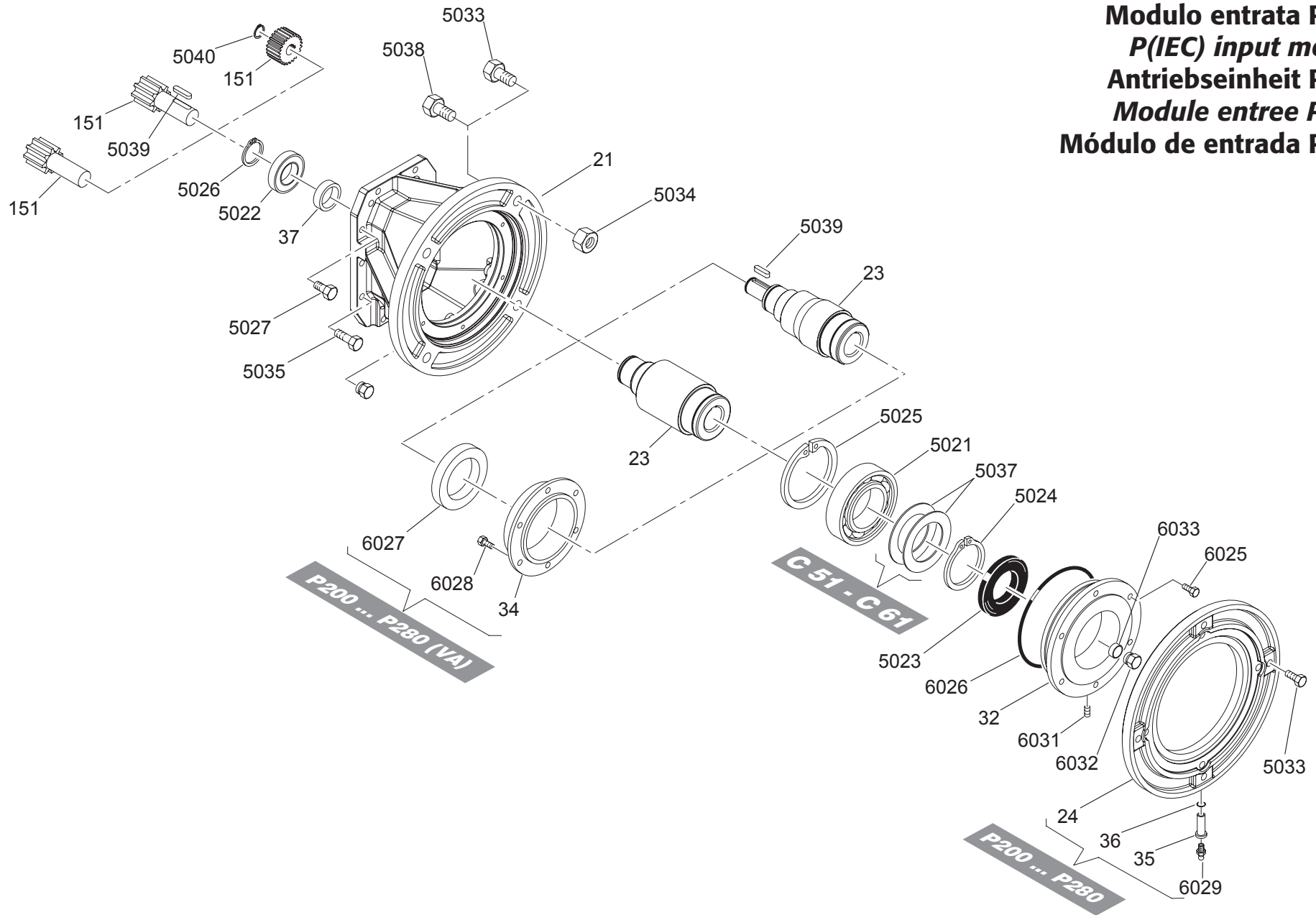







											 OR 6021					 5034				
	5027										5030	5033	5035			6021		5034		
	C 11	C 21	C 31	C 35 - C 41	C 51	C 61	C 70	C 80	C 90	C 100			C 70	C 80	C 90	C 11 ... C 31	C 35 ... C 100	C 35 ... C 100		
P63	M6x20 M6x22	M6x20 M6x22	M8x25	M8x20 M8x25	M10x25 M10x30	M10x30	M12x35				M5x20	M8x20	M12x65			3475	3475			
P71	M6x20 M6x22	M6x20 M6x22	M8x25	M8x20 M8x25	M10x25 M10x30	M10x30	M12x35				M5x20	M8x20	M12x65			3475	3475			
P80	M6x20 M6x22	M6x20 M6x22	M8x25	M8x20 M8x25	M10x25 M10x30	M10x30	M12x35	M12x35	M16x50		M6x25	M10x22	M12x65	M12x65	M16x85	3575	3575			
P90	M6x20 M6x22	M6x20 M6x22	M8x25	M8x20 M8x25	M10x25 M10x30	M10x30	M12x35	M12x35	M16x50		M6x25	M10x22	M12x65	M12x65	M16x85	3575	3575			
P100 P112	M6x20 M6x22	M6x20 M6x22	M8x25	M8x20 M8x25	M10x25 M10x30	M10x30	M12x35	M12x35	M16x50	M16x55	M6x30	M12x30	M12x65	M12x65	M16x85	3575	3800			
P132				M8x20 M8x25	M10x25 M10x30	M10x30	M12x35	M12x35	M16x50	M16x55	M8x25	M12x50	M12x65	M12x65	M16x85		3800	M12		



																			
	5023	5021	5022										5421	5422	5024	5026	5025	5425	
			C 11	C 21	C 31	C 35 - 41	C 51	C 61	C 70	C 80	C 90	C 100	C 35 ... 100	C 35 ... 100				C 35 ... 100	
P63	25x42x7 L	6005-2RS 6005-2RS WT	6006	6006 6006 2Z 6006-2RS WT	6006	6006	6006	6006	6006	6006					25	30	47		
P71	25x42x7 L	6005-2RS 6005-2RS WT	6006	6006 6006 2Z 6006-2RS WT	6006	6006	6006	6006	6006	6006					25	30	47		
P80	40x62x7 L	6008-2RS 6008-2RS WT	6007 6007 ETN9	6007 6007-2Z 6007-2RS WT 6007 ETN9	6007 6007 ETN9	6007 6007 ETN9	6007 6007 ETN9	6007 6007 ETN9	6007 6007 ETN9	6007 6007 ETN9	6007 6007 ETN9	6007 6007 ETN9			40	35	68		
P90	40x62x7 L	6008-2RS 6008-2RS WT	6007 6007 ETN9	6007 6007-2Z 6007-2RS WT 6007 ETN9	6007 6007 ETN9	6007 6007 ETN9	6007 6007 ETN9	6007 6007 ETN9	6007 6007 ETN9	6007 6007 ETN9	6007 6007 ETN9	6007 6007 ETN9			40	35	68		
P100 P112	45x72x8 L	6009-2RS 6009-2RS WT 6012-2RS	6007 ETN9	6007 ETN9 6007 6007-2Z 6007-2RS WT	6007 ETN9	6209	6209	6209	6209	6209	6209	6209	6209		45	35	75		
P132	55x80x8 L	6012-2RS WT				6209	6209	6209	NJ209E	NJ209E	NJ209E	NJ209E	6012-2RS	6209	60	45	95	95	

Modulo entrata P(IEC)
P(IEC) input module
Antriebseinheit P(IEC)
Module entree P(IEC)
Módulo de entrada P(IEC)



Pos.	Descrizione	Description	Benennung	Description	Descripción
21	Coperchio	Cover	Deckel	Couvercle	Tapa
23	Albero veloce	Input shaft	Antriebswelle	Arbre rapide	eje de salida
32	Cappellotto per cuscinetto	Bearing holder	Deckel	Capuchon	Sombbrero para rodamiento
37	Distanziale	Spacer ring	Distanzring	Entretoise	Distanciador
151	Pignone	Pinion gear	Ritzel	Pignon	Piñon





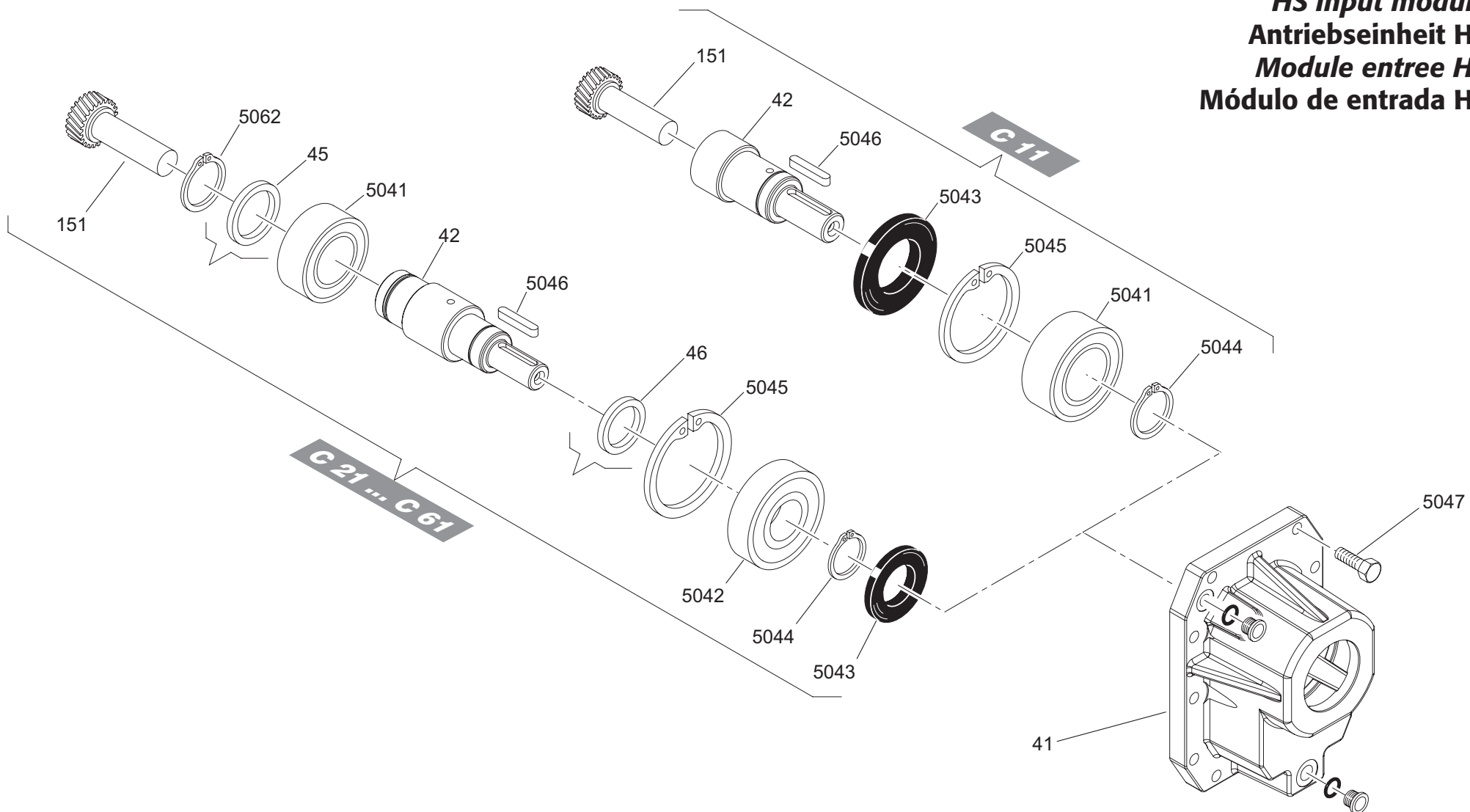

																				
	5021	5022	5039	5024	5026	5040	5025	5037	5034	6029	6031	6033	5023	6027						
							C 51 - C 61		C 80...C 100		C 80...C 100		C 80...C 100		C 51 - C 61		C 70...C 100		C 70...C 100	
P160	6016 6016 2RS 6216 6216 2RS	NUP210 6210 NUP310 6310	8x7x45 A	80	50	30	125 140	80x100x2 P	M16				80x110x10 L	80x110x10 L						
P180	6016 6016 2RS 6216 6216 2RS	NUP210 NUP310 6310 6212	8x7x45 A 14x9x57 C	80	50 60	30 48	125 140	80x100x2 P	M16				80x110x10 L	80x110x10 L						
P200 ... P280	6216 6216 2RS 3216	6310 NUP310 6212 NUP2212	8x7x45 A 14x9x57 C	80	50 60	30 48	140			M6	M10x14	42x50x1.5					80x110x10 L	90x120x12 L		

															
	5027						5033		5035	6025		5038	6028	OR 6026	
	C 51	C 61	C 70	C 80	C 90	C 100	C 51 - C 61	C 70...C 100	C 70...C 90	C 51...C 61	C 70...C 100	C 70 ... C 100	C 80...C 100	C 51 - C 61	C 70...C 100
P160	M10x30 M10x35 M10x45	M10x35	M12x40	M12x40	M16x50	M16x55	M16x60	M16x60	M12x65	M8x25	M8x25			3725	3725
P180	M10x30 M10x35 M10x45	M10x35	M12x40	M12x40	M16x50	M16x55	M16x60	M16x60	M12x65	M8x25	M8x25			3725	3725
P200 ... P280			M12x40	M12x40	M16x50	M16x55		M16x35	M12x65		M8x25	M16x40	M6x16		3725

Modulo entrata HS
HS input module
Antriebseinheit HS
Module entree HS
Módulo de entrada HS

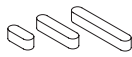



Pos.	Descrizione	Description	Benennung	Description	Descripción
41	Coperchio	Cover	Deckel	Couvercle	Tapa
42	Albero veloce	Input shaft	Antriebswelle	Arbre rapide	eje de salida
45	Distanziale	Spacer ring	Distanzring	Entretoise	Distanciador
46	Distanziale	Spacer ring	Distanzring	Entretoise	Distanciador
151	Pignone	Pinion gear	Ritzel	Pignon	Piñon

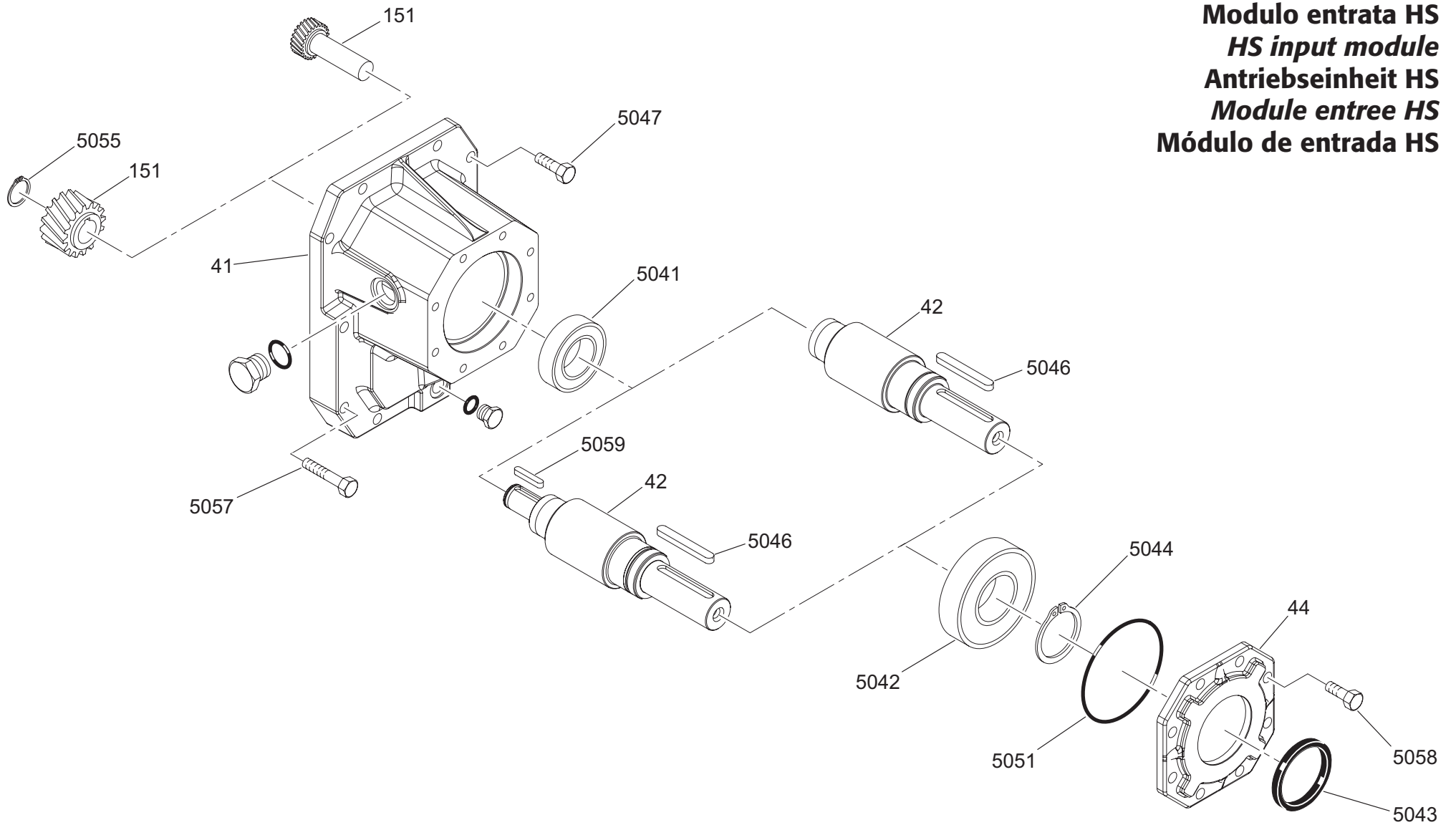

	 5041	5042	 5043	 5046	5044	 5062	 5045	 5047
C 11	3206-2RS		35x62x7 L	5x5x35 A	30		62	T.E. M6x20 T.E. M6x22
C 21	6007	6206-2RS	30x52x7 L	6x6x35 A	30	35	62	T.E. M6x20 T.E. M6x22
C 31	6207	6306-2RS	30x52x7 L	6x6x35 A	30	35	72	T.E. M8x25 T.E. M8x30
C 35	3206-2RS	6208-2RS	35x62x7 L	5x5x35 A	30	50	62	T.C.E.I. M6x20 T.C.E.I. M6x22
C 41	6210 (2x - 3x) 6007 (4x)	6308-2RS (2x - 3x) 6206-2RS (4x)	40x62x7 DL (2x - 3x) 30x52x7 DL (4x)	8x7x45 A (2x - 3x) 6x6x35 A (4x)	40 (2x - 3x) 30 (4x)	50 (2x - 3x) 35 (4x)	90 (2x - 3x) 62 (4x)	T.E. M8x25 T.E. M6x20
C 51	6210 i = 18.9...21.1 NUP 210 i = 2.6...16.6	6308-2RS	40x62x7 DL	8x7x45 a	40	50	90	T.E. M10x35
C 61	6310	6309-2RS	45x72x8 DL	8x7x50 A	45	50	100	T.E. M10x35

Modulo entrata HS
HS input module
Antriebseinheit HS
Module entree HS
Módulo de entrada HS



Pos.	Descrizione	Description	Benennung	Description	Descripción
41	Coperchio	Cover	Deckel	Couvercle	Tapa
42	Albero veloce	Input shaft	Antriebswelle	Arbre rapide	eje de salida
44	Cappello per cuscinetto	Bearing holder	Deckel	Capuchon	Sombbrero para rodamiento
151	Pignone	Pinion gear	Ritzel	Pignon	Piñon

 5041				 5042		 5043		 5046		 5059		
C 70	C 80	C 80	C 100	C 70 ... C 80	C 90 ... C 100	C 70 ... C 80	C 90 ... C 100	C 70 ... C 80	C 90 ... C 100	C 70	C 80	C 90 ... C 100
NJ2210	NJ310 NJ2212	NJ2214E	NJ314E	6312 6312-2RS 6312-2RS WT	6320 6320-2RS 6320-2RS WT	60x90x8 DL	100x120x12 DL	12x8x90 A	18x11x120 A	8x7x45 A	8x7x45 A 14x9x57 C	14x9x57 C

 5044			 5055		 5047		 5057			 5058	
C 70 ... C 80	C 90 ... C 100	C 70	C 80	C 90 ... C 100	C 70 ... C 80	C 90 ... C 100	C 70	C 80	C 90	C 70 ... C 80	C 90 ... C 100
60 → 3 ←	100 → 4 ←	30	30 48	48	M12x40	M16x50	M12x65	M12x70	M16x80	M12x30	M16x40

 OR 5051	
C 70 ... C 80	C 90 ... C 100
3500	3850

R0

	Descrizione	Description	Benennung	Description	Descripción

Questa pubblicazione annulla e sostituisce ogni precedente edizione o revisione. Ci riserviamo il diritto di apportare modifiche senza preavviso. E' vietata la riproduzione anche parziale senza autorizzazione.

This publication cancels and replaces any previous edition and revision. We reserve the right to implement modifications without notice. This catalogue cannot be reproduced, even partially, without prior consent.

Diese Veröffentlichung annulliert und ersetzt jeder hergehende Edition oder Revision. BONFIGLIOLI behält sich das Recht vor, Änderungen ohne vorherige Informationen durchzuführen.

Cette publication annule et remplace toutes les autres précédentes. Nous nous réservons le droit d'apporter toutes modifications à nos produits. La reproduction et la publication partielle ou totale de ce catalogue est interdite sans a autorisation.

Esta publicación anula y sustituye toda anterior edición o revisión. Nos reservamos el derecho de aportar modificaciones sin previo aviso. Se prohíbe la reproducción incluso parcial sin autorización.

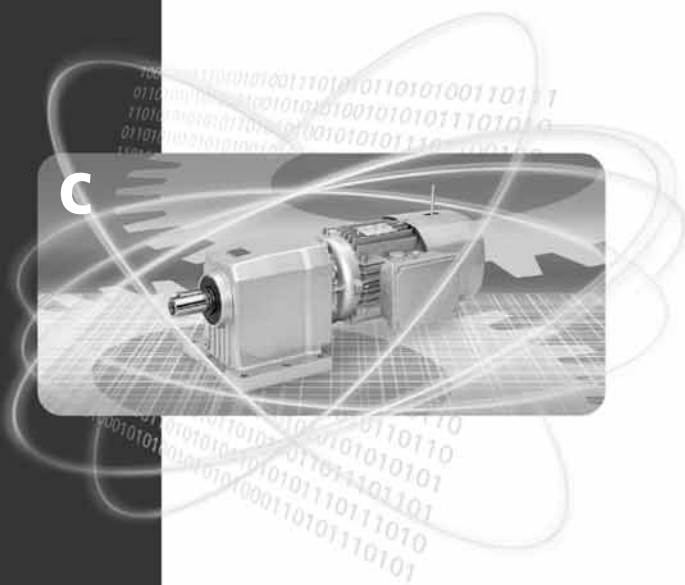

www.bonfiglioli.com

