

Panasonic

Instruction Manual Integrated Drive Brushless Motor with Positioning Function B3-Series, G-type

- Before using this motor, please read this manual. Then keep this manual for your future use.
- This product is for industrial equipment. Do not use this product at general household.



Be sure to give this manual to an end user.



■ Contents

	Page		Page
Safety precautions	2	7. Example setting of motion pattern.....	30
1. Introduction	5	1. Indexing (feeding by fixed length)	30
Overview	5	2. Reciprocating	32
After unpacking	5	3. Automatic reciprocating	34
Nameplate classification.....	5	4. Door opening/closing	36
Model list	6	8. Parameter	38
Name of components	7	Overview of parameter	38
2. Installation.....	8	List of parameters.....	38
Motor	8	LED display.....	44
Gear head	10	9. Protective function	45
Checking the load and use condition	12	What is protective function?	45
3. Maintenance and inspection.....	15	How to clear trip	45
4. System configuration and wiring	16	List of protective functions	46
General wiring diagram	16	Troubleshooting	48
Selecting the wiring equipment	17	10. Conformance to EC directives and UL standards	50
Wiring	18	Configuration of peripheral equipment.....	51
5. How to use the digital keypad	20	Wiring of peripheral equipment.....	51
Function of the digital keypad	20	List of compatible peripheral equipment	52
Using the digital keypad	20	11. Appendix—Detail of parameters.....	53
Description of various modes	22	11. Appendix—RS485 Communication.....	65
Operation of the digital keypad	23	12. Specifications.....	86
Parameter copy function	26	13. Options (sold separately).....	90
6. Test run.....	28	Limited Warranty.....	91
		After-sale service (repair).....	Back cover



Safety precaution

See the following precautions in order to avoid damage and injury for operators and other personnel during operation.

- The following symbols are used to indicate the level of danger when occurred when you fail to observe the safety precautions.

 DANGER	Indicates a potentially hazardous situation, which if not avoided will result in death or serious injury.
 CAUTION	Indicates a potentially hazardous situation, which if not avoided, will result in minor injury or physical damage.

- The following symbols indicate operation status.

 Indicates that the operation is prohibited.
 Indicates that the operation must be followed.

DANGER

Do not subject the product to corrosive or flammable gases, and combustibles.

 Failure to comply could result in fire.

Do not expose the cables to sharp objects, excessive pressing or pinching forces, and heavy loads.

 Failure to comply could result in electric shocks, damages, or malfunction.

Do not step on, nor place a heavy object on the motor.

 Failure to comply could result in electric shock, injury, damage, or malfunction.

Do not touch the rotating part of the motor while operating.

 Failure to comply could result in injuries.

Do not touch the motor body during operation.

 Failure to comply could result in burns.

Be sure to ground the earth line of the motor.

 Failure to comply could result in electric shock.

Conduct the transportation, wiring and inspection after the power off.

 Failure to comply could result in electric shocks and injuries.

Make sure to secure the safety after the earthquake.

 Failure to comply could result in electric shock, injury, or fire.

Wiring must always be configured by competent personnel.

 Failure to comply could result in electric shock, injury, fire, malfunction, and damage.

Attach the motor to incombustible matter such as metal.

 Failure to comply could result in fire.

An over current error, earth leakage breaker, over temperature protector and emergency stop device must be installed.

 Failure to comply could result in electric shock, injury, or fire.

Install the product properly to avoid personal accidents or fire in case of an earthquake.

 Failure to comply could result in electric shock, injury, fire, damage or malfunction.

Install an external emergency stop circuitry to shut down the main power source in any emergency.

 Failure to comply could result in electric shock, injury, fire, damage or malfunction.



CAUTION

Do not hold the cables or motor shaft when transporting the motor.

 Failure to comply could result in injury.

Do not modify, dismantle or repair the product.

 Failure to comply could result in electric shock, injury, or fire.

Safety precautions



CAUTION

Ensure product is isolated correctly in event of a power failure to avoid automatic restart upon power recovery.

 Failure to comply could result in injury.

Never start and stop the motor by magnet contactor, etc. which is provide on the main line.

 Failure to comply could result in damages.

Avoid frequent power on/off switching on main power.

 Failure to comply could result in injury.

Do not drive the motor shaft from outside.

 Failure to comply could result in fire, electric shocks, or damage.

Do not apply excessive pressure to the motor and shaft.

 Failure to comply could result in injury and damage.

Turn off main power when the motor is not required for long periods.

 Failure to comply could result in injuries.

Do not place any obstacle which may disturb ventilation to the motor.

 Failure to comply could result in burns and fire.

Install a safety device for idling or locking of gear head or leakage of grease.

 Failure to comply could result in injury, malfunction and contamination.

Execute test run with the motor fixed and a load unconnected. Connect a load to the motor after the successful test run.

 Failure to comply could result in injuries.

Use the specified voltage on the product.

 Failure to comply could result in electric shock, injury, or fire.

If motor tripping occurs, remove the cause and ensure the machine is safe prior to restarting.

 Failure to comply could result in injuries.

Maintenance and check must be performed by competent personnel.

 Failure to comply could result in injury and electric shock.

This product should be treated as an industrial waste when it is disposed.

1. Introduction

Overview

The B3-Series is a circuit-Integrated Brushless Motor Equipped with Positioning Function.

It integrates a motor and control circuit, motors powers available are from 30W to 130W and gear head ratios from 1/5 to 1/50. It employs a unique CS sensor and has a variable speed range from 30 to 3000r/min along with a positioning function.

Integrating the control circuit with the motor enables space saving and makes wiring easy This also contributes to a reduced panel size and energy savings.

Positioning allows individual setting of (1) Travel distance (2) Maximum rotating speed during travel (preset speed) (3) Accelerating time and (4) Decelerating time during travel allows a positioning selection of up to 4 points. Servo lock during stop is also available.

A programmable digital keypad (sold separately) allows the of display of rotation speed, parameter setting, teaching (setting of target position), copying of parameters and communication software “PANATERM® for BL” (sold separately) which enables adjustment of parameters, monitoring of motor condition, and displaying a waveform graphic to allow fine tuning.

Read this manual carefully in order to make full use of the functions available on the B3 series G-Type.

<Note>

- (1) Copying the whole or part of this manual without notice is strictly forbidden.
- (2) Description of this manual is subject to change without notice.

After unpacking

- Make sure that the model is what you have ordered.
- Check whether the product has been damaged or not during transportation.

If any deficiency should be found, contact the Panasonic partner who sold you this product.

Nameplate Classification

Nameplate

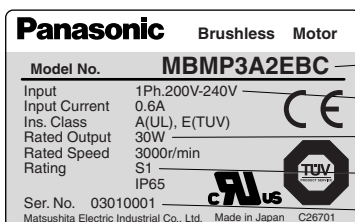

Model name

Rated input voltage

Rated output

S1: Continuous rating, S2: Short-time rating

Serial Number

1. Introduction

Check the Model Name

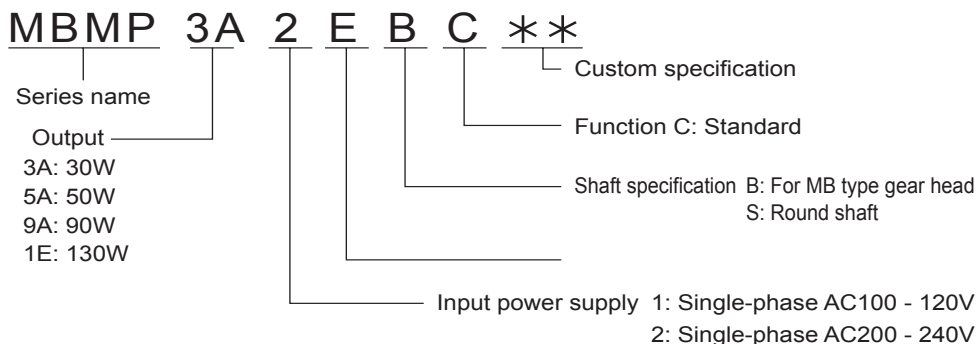

Check the Serial Number

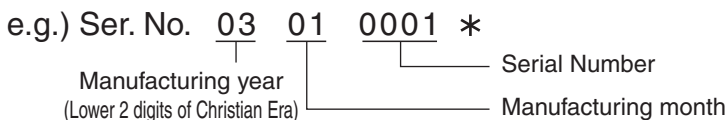

Model list

Model name	Mounting angle dimension	Rated output	Input voltage	Time rating	Model name of applicable gear head	
MBMP3A1EBC	□ 80	30W	AC100 - 120V	Continuous	MB8G □ BV* Reduction ratio: 5, 10, 15, 20, 30, 50	
MBMP3A2EBC			AC200 - 240V			
MBMP5A1EBC		50W	AC100 - 120V			
MBMP5A2EBC			AC200 - 240V			
MBMP9A1EBC	□ 90	90W	AC100 - 120V		30 minutes: 100% of rated output Continuous: 80% of rated output	MB9G □ BV* Reduction ratio: 5, 10, 15, 20, 30, 50
MBMP9A2EBC			AC200 - 240V			
MBMP1E2EBC		130W	AC200 - 240V			
MBMP3A1ESC	□ 80	30W	AC100 - 120V			Continuous
MBMP3A2ESC			AC200 - 240V			
MBMP5A1ESC		50W	AC100 - 120V			
MBMP5A2ESC			AC200 - 240V			
MBMP9A1ESC	□ 90	90W	AC100 - 120V	30 minutes: 100% of rated output Continuous: 80% of rated output		
MBMP9A2ESC			AC200 - 240V			
MBMP1E2ESC		130W	AC200 - 240V			

*A figure representing reduction ration in □

e.g.) Part number of MB type gear head with reduction ratio 10 and mounting angle size □ 80 is MB8G10BV.

Name of components

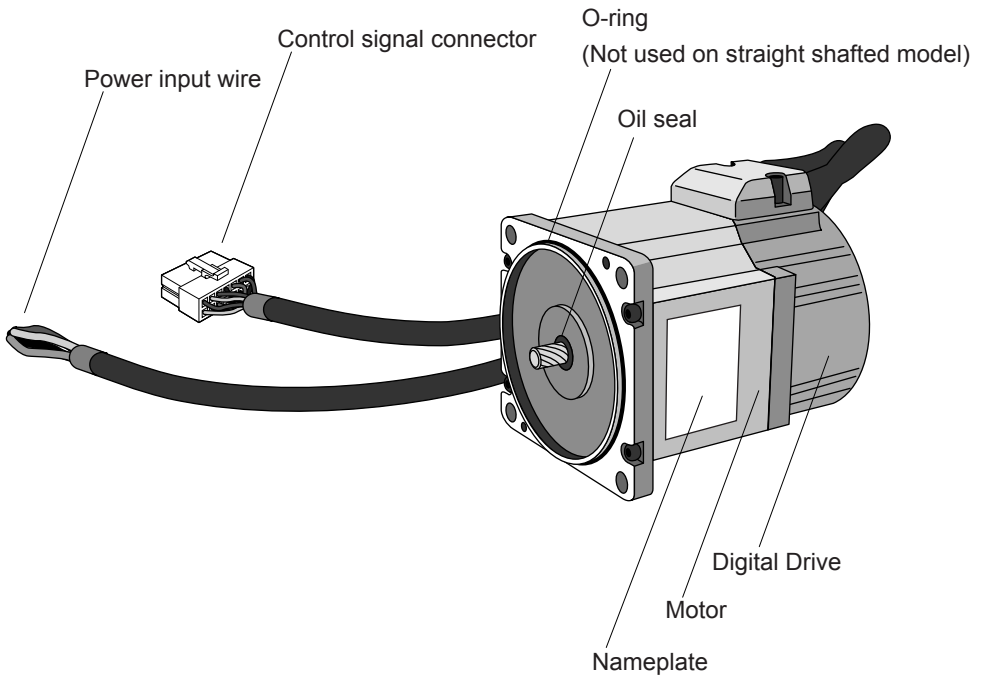

2. Installation

Motor

Location

Location gives great influence upon the life of the motor, therefore please select in conformance with the conditions below:

- ① Indoors where the motor is not subjected to rain water and direct sun light.
- ② Do not use the motor in corrosive atmosphere such as hydrogen sulfide, sulfurous acid, chlorine, ammonia, sulfur, gas chloride, gas sulfide, acid, alkali, and salt, in the atmosphere of combustible gas, or in the vicinity of flammables.
- ③ Place not exposed to grinding liquid, oil mist, iron powder, and cutting particle.
- ④ Well-ventilated place without moisture, oil, or water, and place far from heat source such as a furnace.
- ⑤ Place easy to check and clean
- ⑥ Place free from vibration
- ⑦ Do not use the motor in an enclosed environment. The motor, when enclosed, will run at a higher temperature and reduce the product lifetime.

Environmental condition

Item		Condition
Ambient temperature	Brushless motor	-10 - 40°C (free from freezing)*1
	Digital Keypad (sold separately)	-10 - 50°C (free from freezing)
Ambient humidity		85% RH or below (free from condensation)
Storage temperature and Storage humidity		Normal temperature and humidity*2
Protection structure	Brushless motor	IP65 (excluding output shaft rotating area, and connectors) • This motor conforms to test condition specified in EN standard (EN60529 and EN60034-5). This motor is not applicable to the use which requires long-term waterproof performance, such as the case where the motor is always washed with water.
	Digital Keypad (sold separately)	Equivalent to IP20
Vibration		Not greater than 4.9m/s ² (10 - 60Hz)
Altitude		Not greater than 1000m

*1 Ambient temperature is measured at a distance of 5cm from the motor.

*2 Temperature which is acceptable for a short time, such as during transportation is -20°C to 60°C (free from freezing)

How to Install

The motor can be installed both horizontally and vertically.

See “Outer dimension drawing” on page 88 - 89 for installation dimensions.

Oil and Water Protections

- ① Do not use the motor with the cable immersed in oil or water.
- ② Make sure that the outlet of cable faces down when installing the motor.
- ③ Avoid use in such environment where the motor is always exposed to oil and water.

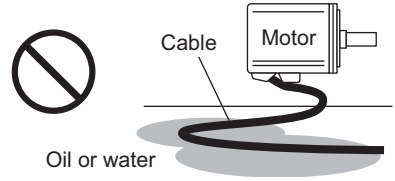

Stress upon Cable

- ① Make sure that the cables are not subjected to stress due to bending forces or self-weight at the cable outlets or connections.
- ② In application where the motor moves, secure the cable attached to the motor to a stationary part, and it should be extended with an additional cable which should be housed in a cable carrier so that bending stress can be minimized. Especially ensure that the bend radius operating part is greater than 30mm.
- ③ Make the bending radius of cables as large as possible. (Minimum bend radius: 20mm or above)

Permissible Shaft Load

- ① Make sure that both radial and thrust load to be applied to the motor shaft during installation and running are within the specified value of each model.
- ② Pay extra attention to installing a rigid coupling (especially if excess bending load is applied as this may damage the shaft or reduce the life of bearing)
- ③ A flexible coupling is recommended which has stiffness as high as possible in order to keep radial load caused by minute misalignment as small as possible.

Installation Notes

- ① Do not hit the shaft with a hammer directly while attaching or detaching the coupling to the motor shaft end.
- ② Ensure sufficient alignment. (Insufficient alignment may cause vibration and damage the bearing.)
- ③ The motor is integrated with the control circuit, therefore pay attention to temperature, vibration, and shock.
- ④ This motor is controlled by switching of power device at a high speed. Therefore when the motor is operated, the leakage current increases, which may activate the leakage breaker. In this case, use a leakage breaker which is provided with high frequency measure for an inverter.

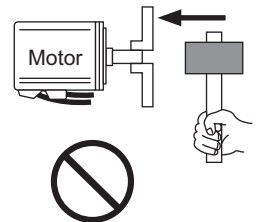

2. Installation

Gear head

Assembling of Gear Head

● Preparation before assembling

- ① Gear head applicable to the motor described in this instruction manual is MB8G□BV (for 30W and 50W) and MB9G□BV (for 90W and 130W). Never use a combination of gear heads other than applicable ones.
- ② Make sure that O-ring is attached to the bottom of spigot joint.
When the gear head is assembled with O-ring floating, it may result in grease leakage.
- ③ When grease adheres to the end surface of gear head, wipe off clean.
If the gear head is assembled with grease adhered, it may cause grease to exude.

● Assembling

- ① Direct the motor pinion upward, and make sure that the relation between direction of motor lead wire and output shaft matches with the equipment.
- ② Turn the motor pinion finely clockwise and counterclockwise for assembling, ensuring that the tip of motor pinion does not hit the tooth of gear head.

<Information>

MB type gear head is provided with temporary assembling screw. Before installing the equipment, assemble the motor and gear head temporarily, which will ensure stable installation of the equipment. In installing to the equipment, be sure to use four "mounting screws" attached to the gear head for secure installation.

[Recommended tightening torque for temporary assembling]

Mounting dimension	Type of gear head	Screw size	Tightening torque
□80	MB8G	M2.6	0.5N·m
□90	MB9G	M3	0.8N·m

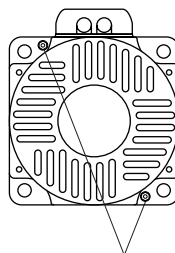

Temporary assembling screw

- ③ When installing the motor and gear head to the mating equipment, use “mounting screws” attached to the gear head, tighten them sufficiently to eliminate clearance between the motor flange surface and gear head spigot joint while paying attention to bite of O-ring.

Recommended tightening torque is shown below:

Mounting dimension	Type of gear head	Screw size	Tightening torque	Installing pitch diameter
□80	MB8G	M6	2.9N•m	94mm
□90	MB9G	M8	7.8N•m	104mm

Note) Excessive force to assemble the motor and gear, or damage to the tip of motor pinion or tooth of gear head may generate abnormal noise or reduce the life.

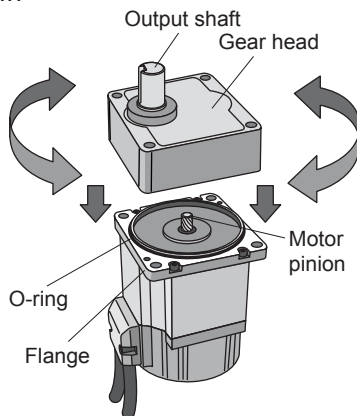

Assemble with motor pinion faced up.

Caution in Installing Gear Head

Idling by damaged tooth, locking by bite, grease leakage, and the like are possible on the life end of gear head. Install a safety protection in order to ensure safety even if such trouble happens.

- Install a device for preventing drop by damaged teeth on a lifter or the like.
- As for application such as automatic door, install a torque limiting device to prevent against gearlock.
- As for food or textile equipment, install an oil pan for measure against grease leakage.
- Do not install an encoder, sensor, contact, etc in the proximity of gear head. If you should install such devices, take measures against their grease leakage.
- Be sure to perform daily check in order to prevent unexpected accident.

Caution in Storing Gear Head

In storing the gear head separately, make sure that output shaft is faced down. (Incompliance may lead to grease leakage.)

2. Installation

Checking the load and use condition

Some environment conditions may possibly lead to heating or damage to the shaft. Check conditions, and use the motor within its permissible range.

● Standard life

Standard life is 10,000 hours for the motor equipped with gear head (MB8G and MB9G). Standard life is the same 10,000 hours for motor alone (round shaft). (Standard life of sealing performance of oil seal is 5,000 hours.)

Standard life refers to design life for operation 8 hours per day (service factor: Sf = 1.0) at a normal temperature and humidity, under uniform load (permissible shaft torque of gear head and rated torque of motor).

<Information>

Repeated forward/reverse operation with motor shaft rotation angle below 45 degrees causes fretting of bearing (partial wear due to bearing out of grease), and is not advisable. It does not apply if operation is available to rotate the motor shaft above 45 degrees at an appropriate interval more than once a day.)

Oscillation due to inappropriate setting of gain, also causes fretting.

Note that gear head shaft is also subject to this restriction.

● Service factor (Sf)

$$\text{Expected life} = \frac{\text{Standard life}}{\text{Service factor (Sf)}}$$

Service factor (Sf) depends on the magnitude of shock of load or operating time. Service factor is shown below for different load conditions:

Type of load	Example of load	Service factor		
		5 hours/day	8 hours/day	24 hours/day
Uniform load	One direction continuous operation	0.8	1.0	1.5
Light shock	Start, stop, or cam shock	1.2	1.5	2.0
Middle shock	Instantaneous rotation/reverse rotation and instantaneous stop	1.5	2.0	2.5
Heavy shock	Middle shock at a high frequency	2.5	3.0	3.5

● Permissible shaft torque

Required shaft torque TA of gear head can be obtained from service factor and actual load torque T1.

$$TA = T1 \times Sf$$

Select a gear head and motor to ensure that required torque (continuous) is within permissible shaft torque in the table below. Here, the torque T1 must not exceed permissible shaft torque TA irrespective of Sf.

Unit : N m

Model name (motor/gear head)	Reduction ratio	5	10	15	20	30	50
MBMP3A□EBC / MB8G□BV		0.43	0.86	1.3	1.8	2.5	4.1
MBMP5A□EBC / MB8G□BV		0.71	1.4	2.2	2.8	4.0	6.8
MBMP9A□EBC / MB9G□BV		1.2	2.5	3.6	4.9	7.0	11.6
MBMP1E2EBC / MB9G□BV		1.9	3.7	5.6	7.4	10.7	17.7

Rotation direction is the same as that of motor in shaded portion, and reverse for others.

● Permissible shaft load

Use the permissible shaft load within the load shown below:

	Model name	Permissible overhang load (W)	Permissible thrust load (F)
Motor (Round shaft)	MBMP3A□ESC	100N	10N
	MBMP5A□ESC	100N	10N
	MBMP9A□ESC	150N	20N
	MBMP1E2ESC	150N	20N
Gear head	MB8G5BV	245N	98N
	MB8G10BV - 20BV	343N	
	MB8G30BV - 50BV	539N	
	MB9G5BV	294N	147N
	MB9G10BV - 20BV	490N	
	MB9G30BV - 50BV	637N	

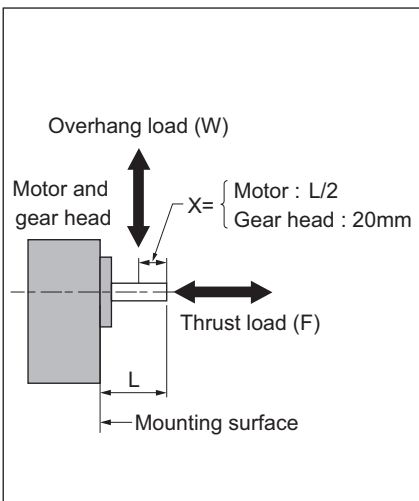

<Information>

- in the part name of motor represents either 1 or 2 which indicates supply voltage.
- in the part name of gear head represents a figure which indicates reduction ratio.

2. Installation

● Permissible load inertia moment

Apply permissible load inertia moment within the value shown below:

Speed reduction time from 3000r/min to 0 shall be 1 second.

Equipped with gear head

Unit : $\times 10^{-4}\text{kg}\cdot\text{m}^2$

Model name \ Reduction ratio	5	10	15	20	30	50
MBMP3A□EBC	3.42	13.8	30.6	55.8	127	342
MBMP5A□EBC						
MB8G□BV						
MBMP9A□EBC	16.4	67.6	142	257	589	1684
MBMP1E2EBC						
MB9G□BV						

Round shaft

Unit : $\times 10^{-4}\text{kg}\cdot\text{m}^2$

Model name \ Reduction ratio	5
MBMP3A□ESC	0.87
MBMP5A□ESC	
MBMP9A□ESC	1.54
MBMP1E2ESC	

<Information>

- □ in the part name of motor represents either 1 or 2 which indicates supply voltage.
- □ in the part name of gear head represents a figure which indicates reduction ratio.

3. Maintenance and inspection

Routine maintenance and inspection are essential for proper and satisfactory operation of the motor.

Notes to Maintenance/Inspection Personnel

- Power-on/off operations should be done by the operators themselves for ensuring safety in checking.
- Do not touch the motor while power on. (Motor body maintains a high temperature.)
- In performing the measuring insulation resistance, remove all connections. Measuring insulation resistance with connection can cause brushless motor failure.

Maintenance/Inspection item

Inspection item	Inspection procedure	Condition
Input voltage	Voltmeter	Must be within $\pm 10\%$ of rating.
Input current	Ammeter	Must be within rated input current described on nameplate.
Insulation resistance	Insulation resistance tester	Insulation resistance of motor, when measured with 500V, must be 1 Mohm or above. Measuring position: Between power input (L1, L2) and earth
Noise	Hearing	Noise level must not be different from the usual level. In addition, abnormal noise such as rumbling noise must not be heard.
Vibration	By hand	Free from abnormal vibration.
Grease leakage	By sight	Check that periphery of motor or gear head is not wet by grease or oil. Protect them with a cover etc. in application which is deteriorated by grease leakage.
Installation bolt	Torque wrench	Check for loosening of bolt, and tighten additionally as necessary.

4. System configuration and wiring

General wiring diagram

■ Wiring of Main Circuit

Non-Fuse Breaker (NFB)

Used to protect the power lines.
Overcurrent will shut off the circuit.

Noise Filter (NF)

Prevents the external noise from the power line, and reduces the effect of the noise generated by the motor.

Magnetic Contactor (MC)

Turns on/off the main power to the motor.
Used together with a surge absorber.

•Never start or stop the motor with the magnetic contactor.

<Note>

This motor is controlled by switching of power device at a high speed. Therefore when the motor is operated, leakage current increases, which may activate the leakage breaker. In this case, use a leakage breaker which is provided with high frequency measure for inverter.



Be sure to ground the unit.

Use wire above diameter 1.6mm (2.0mm²) for both of main circuit and grounding for the wiring on power supply side of non-fuse breaker (outside the equipment). Apply grounding to be 100 ohms or less. Do not tighten the ground wires together but connect individually.

Lead wire is 0.5m long.

Gear head
(sold separately)

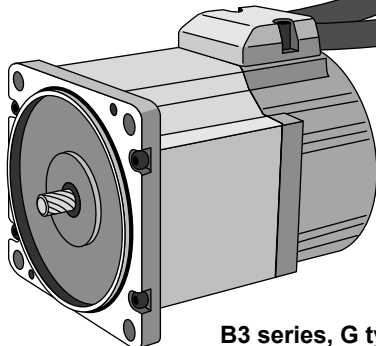
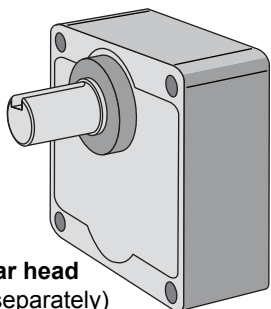

B3 series, G type

Selecting the wiring equipment

Noise filter

Recommended noise filter
part number

Our option part number	Manufacturer's part number	Manufacturer's name
DV0P3611-5	SUP-EQ5-ER-6	Okaya Electric Industries Co., Ltd

Non-fuse breaker, magnetic contactor, and electric wire

* Made by Matsushita Electric Works Co., Ltd

Voltage	Capacity (W)	NFB* (rated current)	Magnetic contactor* (contact structure)	Electric wire (mm ²)	
				Main circuit/Grounding wire	Control circuit
Single phase 100V	30 - 90	BBC25N (5A)	BMFT61041N (3P+1a)	0.5 (AWG20)	0.13 (AWG26)
Single phase 200V	30 - 130	BBC25N (5A)	BMFT61042N (3P+1a)	0.5 (AWG20)	0.13 (AWG26)

(See "10. Conformance to EC directives and UL standards" on page 50.)

<Information>

Connection with control signal connector—See "Wiring" on page 18 for details.

[In connecting with digital keypad or PC]

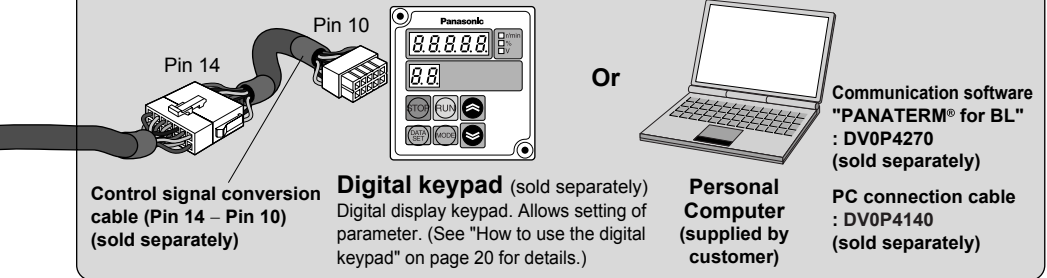

Control signal conversion cable (Pin 14 – Pin 10) (sold separately)

Digital keypad (sold separately)
Digital display keypad. Allows setting of parameter. (See "How to use the digital keypad" on page 20 for details.)

Personal Computer (supplied by customer)

Communication software "PANATERM® for BL" : DV0P4270 (sold separately)

PC connection cable : DV0P4140 (sold separately)

[In extending the cable]

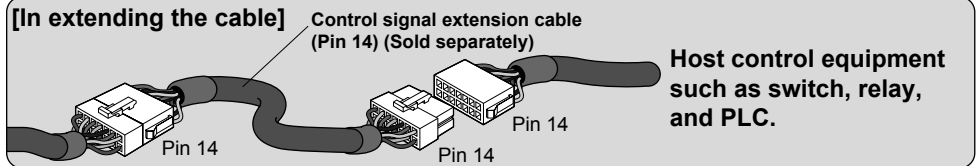

Control signal extension cable (Pin 14) (Sold separately)

Host control equipment such as switch, relay, and PLC.

[When connecting the digital keypad with external input equipment, etc.]

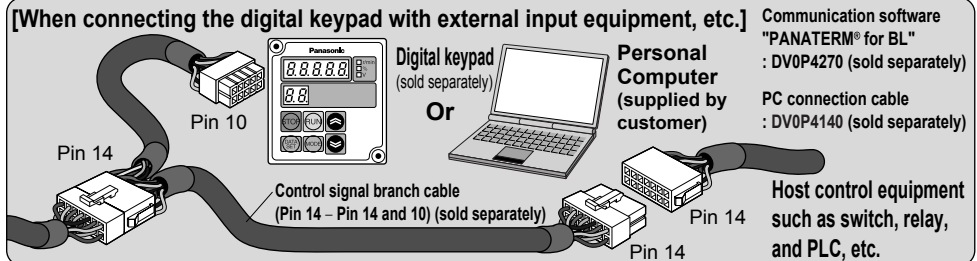

Control signal branch cable (Pin 14 – Pin 14 and 10) (sold separately)

Digital keypad (sold separately)

Personal Computer (supplied by customer)

Communication software "PANATERM® for BL" : DV0P4270 (sold separately)

PC connection cable : DV0P4140 (sold separately)

Host control equipment such as switch, relay, and PLC, etc.

● See "13. Option (sold separately)" on page 90 for details of separately sold cable.

4. System configuration and wiring

Wiring

- Wiring work must always be performed by a professional.
- Do not turn on power before finishing wiring for avoiding electric shock.

Standard Wiring Diagram

Be sure to ground the unit.

Use wire above diameter 1.6mm (2.0mm²) for both of main circuit and grounding for the wiring on power supply side of non-fuse breaker (outside the equipment). Apply grounding type D (100 ohms or below).

Do not tighten the ground wires together but connect individually.

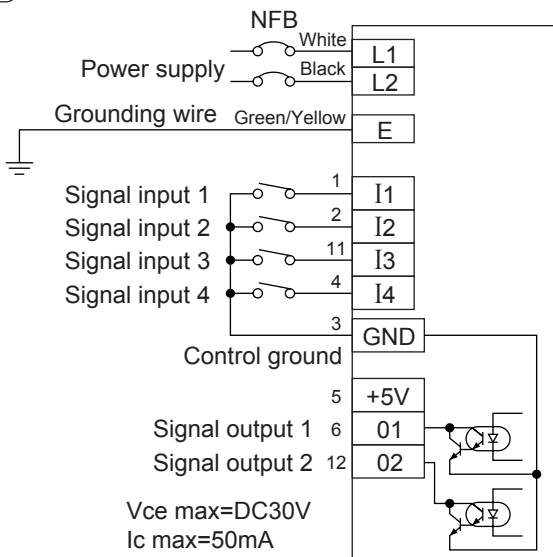

Relay

Use a relay for small signal (minimum guaranteed current 1mA or below) for connecting to control circuit such as control input terminal (“I1” – “I4”) in order to prevent poor contact.

<Example> Matsushita Electric Works: DS, NK, or HC type, Omron: G2A type

Control Circuit Switch

When using a switch instead of relay, use one for minute current in order to prevent poor contact.

<Example> Nihon Kaiheiki: M-2012J-G

Function of terminal

- Power input

Color of wire	Name	Description of function
White, Black (L1, L2)	Power input wire	Connect with commercial power supply conforming to voltage specification.
Green/Yellow (E)	Grounding wire	Wire for grounding the motor

● Control signal connector

Part number of connector: 39-01-2145 (5557-14R-210) (Molex Incorporated)

Terminal symbol	Terminal number	Terminal name	Default	Description of function	Cable color
I1	1	Signal input 1	Run start	Select a function with Pr50. In turning on signal, short between "I1" and "GND". (Input logic can be changed by Pr54.)	Brown
I2	2	Signal input 2	Point designation 1	Select a function with Pr51. In turning on signal, short between "I2" and "GND". (Input logic can be changed by Pr55.)	Red
GND	3	Control ground		Common ground terminal for control signal	Orange
I4	4	Signal input 4	Forced trip	Select a function with Pr53. In turning on signal, short between "I4" and "GND". (Input logic can be changed by Pr57.)	Yellow
+5V	5	Power supply for digital keypad		Power supply for digital keypad. When using power for other than digital keypad, set 50mA or below.	Green
O1	6	Signal output 1	Trip output	Open collector output. Choose a function with Pr5C. (Output logic can be changed by Pr5E.)	Blue
SCK	7	Digital keypad I/F		Interface for digital keypad	Purple(pink) Gray White
SIN	8				
SOT	9				
(N/A)	10	–		Do not connect anything.	Black
I3	11	Signal input 3	Home sensor	Select a function with Pr52. In turning on signal, short between "I3" and "GND". (Input logic can be changed by Pr56.)	White/ black
O2	12	Signal output 2	In-motion signal	Open collector output. Choose a function with Pr5d. (Output logic can be changed by Pr5F.)	White/ red
RS485-	13	RS485 I/F		Connect RS485 (-)	White/green
RS485+	14			Connect RS485 (+)	White/blue

<Note>

- Do not connect anything to pin 10.
- Do not touch the terminal of energized control circuit.
Static electricity or the like may lead to malfunction.
- Circuit of input terminal is as shown on the right.
It can be controlled by contact or open collector output.
- **When extending the control signal, a maximum of 5m cable length can be used.**

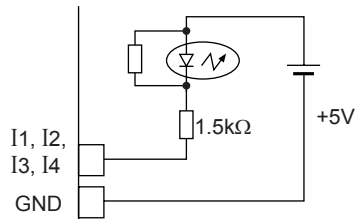

<Specification of connector>

Applicable plug: 39-01-2146 (5559-14P-210) (Molex Incorporated)

Applicable terminal: 39-00-0040 (5558T) Chain type for AWG18 - 24



39-00-0041 (5558TL) Bulk type for AWG18 - 24

39-00-0048 (5558T2) Chain type for AWG22 - 28

39-00-0049 (5558T2L) Bulk type for AWG22 - 28 (Molex Incorporated)

5. How to use the digital keypad

Function of the digital keypad







- Monitoring of rotation speed (actual speed) and load factor
- Display detail of trip, and trip history. Trip reset by pressing  and 
- Parameter setting and copying function at the same time.
- Teaching function (Target point (positioning point) can be set by actually starting the motor.)
 - **Control signal conversion cable (DV0P38605 sold separately) is required for connecting the digital keypad. In using the digital keypad and control signal input at the same time, buy an optional control signal branch cable (DV0P38805 sold separately).**

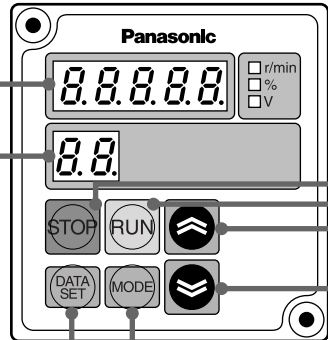







Using the digital keypad

- When power is turned on, rotation speed (actual speed) r/min is displayed in monitor mode (changeable by Pr7A).
- Displayed value is an index. Do not use the digital keypad for a measuring instrument.

5-digit LED	<ul style="list-style-type: none"> ■ In monitor mode Displays rotation speed (actual speed), commanded speed, present position, trip history, and the like. ■ In parameter editing Displays a parameter setting value. ■ In teaching Displays present position of motor. <ul style="list-style-type: none"> •  is displayed for indicating a negative value.
--------------------	---











2-digit LED	<ul style="list-style-type: none"> ■ In monitor mode The left value (position of 10) indicates an operation command signal status. ( : Stand still,  : Commanding) The right value (position of 1) indicates a rotation direction and operation status. ( : Operating in direction +*,  : Operating in direction -*,  : Stand still,  : Motor is free) ■ In parameter editing Displays the number of parameter. ■ In teaching Displays the point number of parameter. <p>* Rotation direction is changed by Pr23. Direction + (): CCW rotation when viewed from motor output shaft (default).</p>
--------------------	--

 <p>STOP Switch</p>	<p>When STOP switch is pressed, the setting change warning LRU (CAU) is displayed, and the motor is stopped and tripped.</p>
 <p>RUN Switch</p>	<ul style="list-style-type: none"> ■ In monitor mode When this switch is pressed for about 4 seconds, system shifts to teaching mode. ■ In teaching When homing is not completed, homing operation is executed by pressing this switch for about 4 seconds in teaching mode.
 <p>Switch</p>	<ul style="list-style-type: none"> ■ In monitor mode Trip reset can be executed by pressing  and  at the same time. ■ In parameter editing This switch allows selection of parameter, and setting and changing of details. Parameter changes continuously while this switch is held down. ■ In teaching When homing is completed, teaching operation (motor drive) is enabled by the switch  and .
 <p>MODE Switch</p>	<ul style="list-style-type: none"> ■ In monitor mode Switch for changing monitor mode. Whenever this switch is pressed, the mode changes in this sequence: Rotation speed (actual speed) → Internal DC voltage (voltage of smoothing capacitor in power supply) → Load factor → Torque → Commanded speed → Present position (lower 5 digits) → Present position (shaft rotation number) → Rotation speed (actual speed) → ■ In parameter editing, and in teaching System shifts to monitor mode. (Setting is not saved in EEPROM.)
 <p>DATA SET Switch</p>	<ul style="list-style-type: none"> ■ In monitor mode System shifts to parameter number mode. ■ In parameter editing This switch is for changing parameter number mode and parameter setting mode, and for saving parameter setting in EEPROM. ■ In teaching This switch is for changing point number mode and teaching mode, and for saving setting in EEPROM (nonvolatile memory built in the motor).

5. How to use the digital keypad

Description of various modes

Monitor mode	<p>Displays rotation speed (actual speed), commanded speed, internal DC voltage, load factor, torque, and present position on 5-digit LED. This mode is set when power is turned on.</p> <p>Control changes to this mode when MODE switch is pressed in parameter number mode, parameter setting mode, point number mode, and point setting mode.</p>
Parameter number mode	<p>Displays a parameter number ($00 - 99$) in flashing.</p> <p>Control changes to this mode when DATA SET switch is pressed in parameter number mode.</p> <p>Parameter number can be changed and selected by  and  switch.</p>
Parameter setting mode	<p>Displays the detail of parameter (setting) in flashing.</p> <p>Control changes to this mode when DATA SET switch is pressed in monitor mode.</p> <p>Change setting by  and  switch.</p> <p>When DATA SET switch is pressed after change of setting, it is saved in EEPROM.</p>
Point number mode	<p>Displays a parameter number ($01 - 04$) in flashing.</p> <p>Control shifts to this mode when RUN switch is pressed for 4 seconds in monitor mode.</p> <p>Point number can be changed and selected by  and  switch.</p>
Teaching mode	<p>Displays the present position of motor (distance from home) in flashing. (If homing is not completed, $- - - -$ is displayed.)</p> <ul style="list-style-type: none"> ● When present position is greater than 99999, 00000 is displayed. ● When present position is smaller than -99999, 00000 is displayed. <p>Ex. 1) When present position is 123456, only lower 4 digits 3456 are displayed.</p> <p>Ex. 2) When present position is -20, 00020 is displayed.</p> <p>Control shifts to this mode when DATA SET switch is pressed in point number mode.</p> <p>When  or  switch is pressed after completion of homing, the motor can be operated.</p> <p>If homing is not completed yet, homing operation is started when RUN switch is pressed for 4 seconds.</p> <p>When DATA SET switch is pressed, the present position is set in parameter as a point setting, and saved in EEPROM</p>

<Information>

Present position is the distance from the home, indicated in pulses (288 pulses/rotation).

Operation of the digital keypad

Basic operations

Power-on ↓ Displays monitored details set by Pr7A (see page 43).

Monitor mode

● Changes display on 5-digit LED with **MODE** switch.

MODE ↑

DATA SET ↓

Parameter number mode

Displays the contents of displayed parameter (setting).
Displays parameter number.

- Number is changed by and switch.
- Exit this mode with **MODE** switch (returns to monitor).

MODE ↓

DATA SET ↓

DATA SET ↑

MODE ↓

DATA SET ↑

Trip detail display mode

When trip occurs, trip display is set by **MODE** switch.

- Trip can be reset by pressing and switch at the same time. Display shifts to monitor screen after resetting.
- Shifts to parameter number mode when **DATA SET** switch is pressed.

Parameter setting mode

- Value is changed by and switch. (Such value is effective on the spot.)
- Value is written in EEPROM by **DATA SET** switch.
- Exit this mode with **MODE** switch without writing in EEPROM.

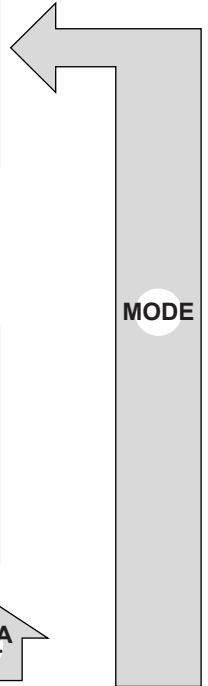
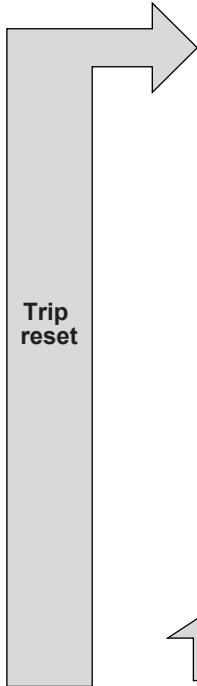

5. How to use the digital keypad

Monitor mode

Monitor display item can be changed after power is turned on and when monitor mode display is on. (See page 43 for setting of Pr7A.)

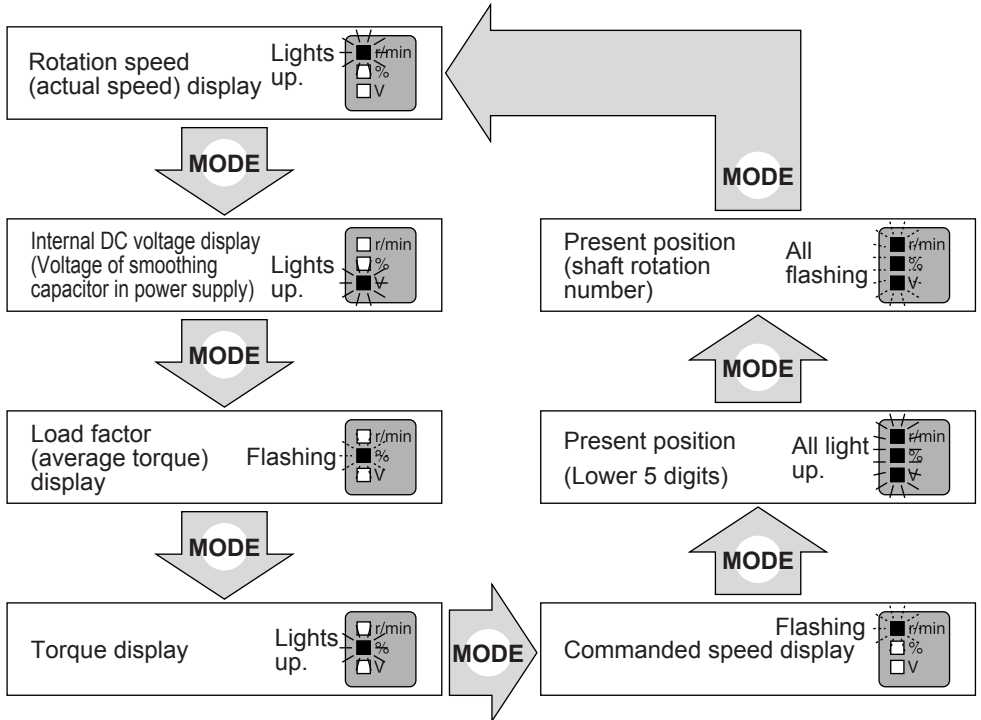

Display of present position

- When homing is not completed, is displayed.
 - When present position is greater than 99999, is displayed.
When present position is smaller than -99999, is displayed.
- Ex. 1) When present position is 123456, only lower 4 digits are displayed.
Ex. 2) When present position is -20, is displayed.

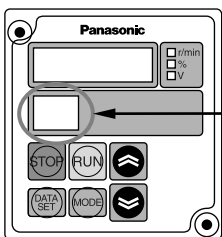

Left (position of 10)

... Displays command status.

- : Stand still
- : In Motion (BUSY)

Right (position of 1)

... Displays rotation direction.

- : Running in - direction.
- : Running in + direction.
- : Stand still
- : Motor is free.

Teaching function

This motor allows two target position setting methods, one of which is setting by parameter value, and the other is setting target position by actually operating the motor by use of teaching function.

In order to use teaching function, press **(RUN)** switch for 4 seconds or longer on the monitor mode display screen, then control shifts to point number mode of teaching function.

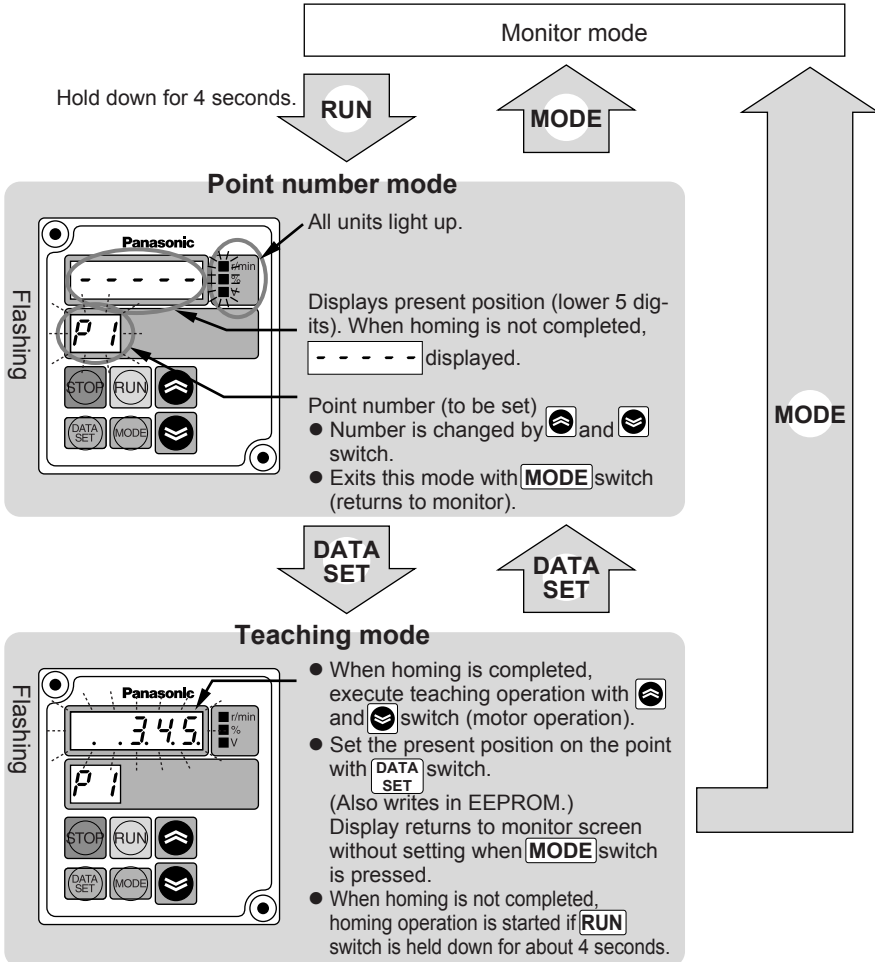

[Caution]

- In teaching mode, displayed present position is set as target position.
- Set the point coordinate setting to absolute travel. (Pr02, 0A, 12, and 1A).
When the point coordinate setting is set to relative travel, stop position is different between teaching setting and actual operation.
- In point number mode and teaching mode, operation instruction by I/O or RS485 is not accepted.

5. How to use the digital keypad

Parameter copy function

Parameter copy function (Digital keypad ↔ Motor) can be used by Pr77.

● Initializing the data of the digital keypad

EEPROM installed onboard the digital keypad is initialized (data cleared). When reading is disabled, or when data transfer fails during copying, execute "Data initialization of the digital keypad". Normally, it is not required.

● Reading parameters

Parameter of motor is read and saved in EEPROM of the digital keypad. Read parameter is retained even when the digital keypad is separated from the motor.

● Writing parameters

Parameter information saved in the digital keypad is written to the motor. (Saved in EEPROM of motor)

<Information>

● Error in copying parameters

P.E.r.r.1 : Data trouble was found during copying

→ Press **STOP** switch for clearing, and then copy the parameter again. If data trouble is still found, initialize the digital keypad and try again.

P.E.r.r.2 : Copy error

→ This error occurs in the attempt to copy data between products with different function. Press **STOP** switch to cancel the error.

Although parameters can be copied between the same models with different output, parameters should be copied between the same outputs in principle.

<Note>

Do not turn off power or disconnect the connection cable of digital keypad during operation such as "Initializing data of digital keypad", "Reading parameter into digital keypad", "Writing parameter to brushless motor", etc.

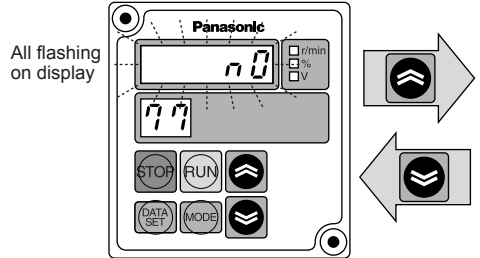

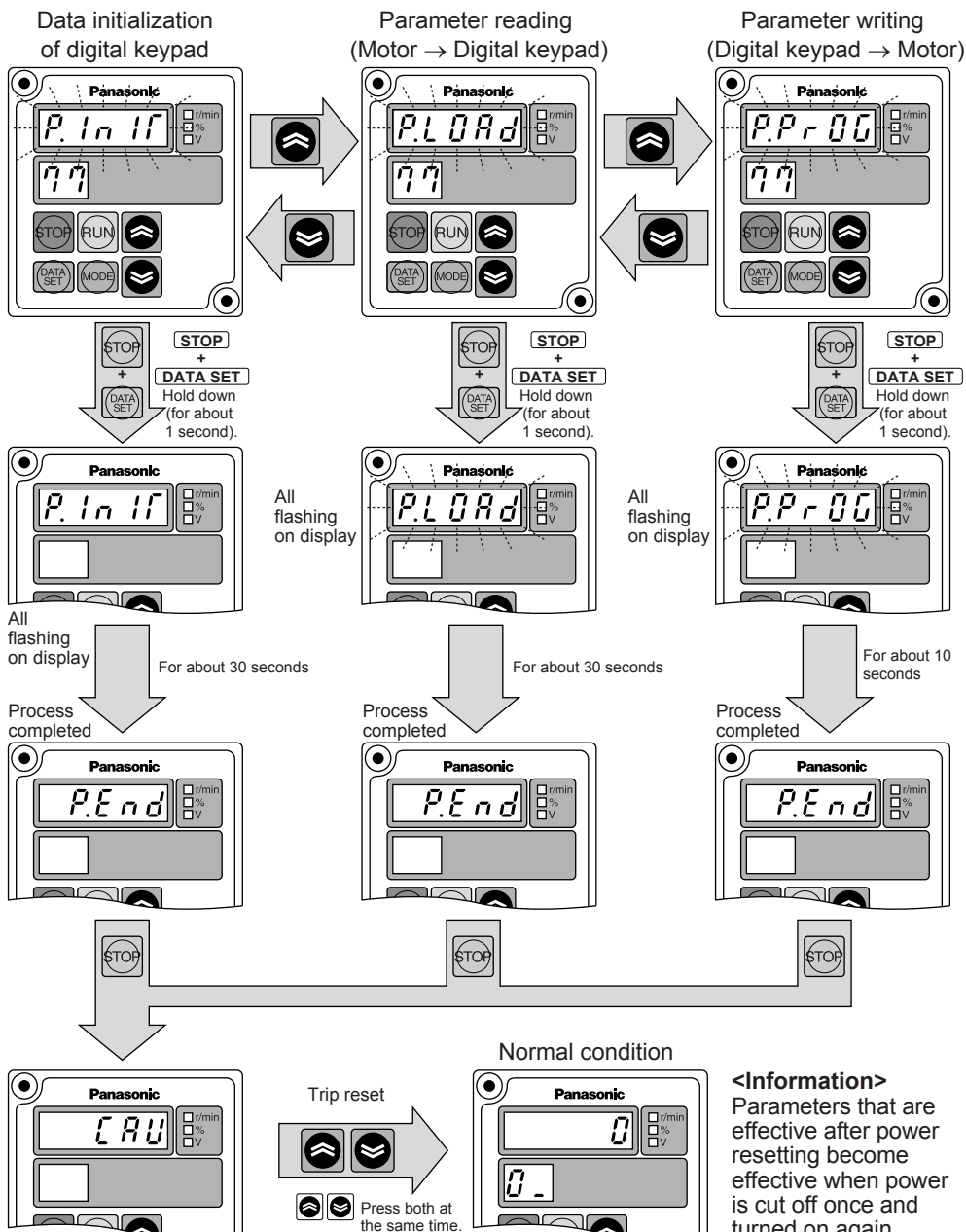

6. Test run

Inspection before Test Run

- 1) Make sure that all wiring is correct.
- 2) Make sure that input power supply conforms to rating.











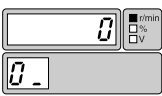

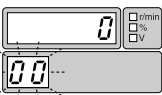
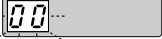
Test Run

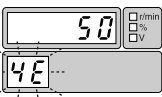
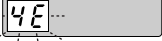

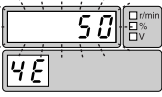

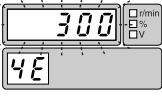

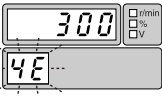

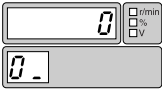

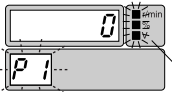

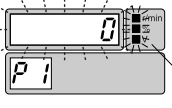
Procedure for test run using the digital keypad is as follows:

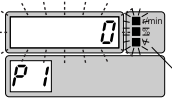
Shown here is the case of running at 300r/min in direction CW or CCW by use of teaching function.

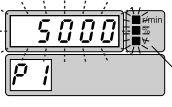
First execute the following work for safe operation.

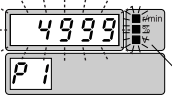
- ① Ensure that the motor alone can be operated.
- ② Turn on power and follow the steps below for test run.

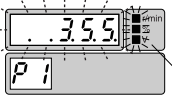
Description of operation	Operation panel	
	Switch	LED display
1. Turn on power		
2. Set the action Pr4E (Setting of teaching speed)	Press 	 Flashing: 
	Press  and choose parameter 4E (teaching speed). (Initial setting: 50)	 Flashing: 
	Press 	 Flashing: 
	Press  and change the teaching speed to 300.	 Flashing: 
	Press 	 Flashing: 
3. Return to monitor mode.	Press 	

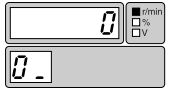
Description of operation	Operation panel	
	Switch	LED display
4. Teaching operation	Press  for 4 seconds	Flashing:  All light up.
	Press 	Flashing:  All light up.
	 When  is pressed in this condition, the motor rotates in + direction* and 5-digit LED indicates position coordinates.	Flashing:  All light up.
	 When  is released, the motor stops. (LED display "5000" is an example, which shows the present position of the motor.)	Flashing:  All light up.
	 When  is pressed after the motor has stopped, the motor rotates in one direction.	Flashing:  All light up.
	 When  is released, the motor stops. (LED display ". . 355." indicates that the present position is -355.)	Flashing:  All light up.
5.Exit	When exiting the mode without setting data, press  MODE switch to return to monitor mode.	

Checkpoint in Test run

- ① Check whether the motor rotates smoothly. Check for abnormal noise and vibration.
- ② Check whether the motor is accelerated and decelerated smoothly.
- ③ Make sure that the direction of motor rotation is correct.

*Rotation direction + represents CCW on the motor shaft in default setting. (Can be changed by Pr23 coordinate system setting.)

Rotation direction of gear head output shaft may sometimes be reversed due to reduction gear ratio when gear head is installed.

(See the table of permissible shaft torque on page 13. Rotation direction is described.)

7. Example setting of motion pattern

1. Indexing (feeding by fixed length)

- When feeding by fixed length of travel

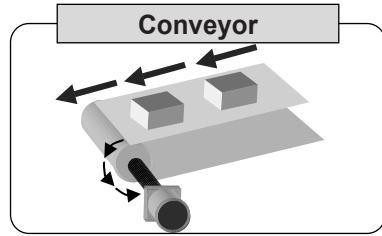
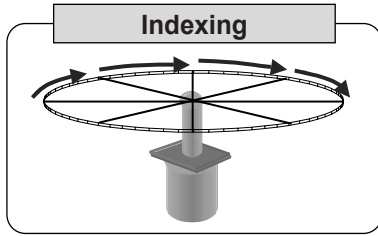

<Example of setting>

- Every time I1 is turned on, the motor runs for fixed travel distance.
- Homing operation is executed and the home is set when I1 is turned on just once after power-on. (It is also possible to set power-on position to the home.)

[Signal function setting]

Terminal symbol	Terminal number	Terminal name	Description of function
I1	1	Signal input 1	Operates when "I1" and "GND" are shorted (Homing operation for the first time after power-on)
I2	2	Signal input 2	CW operation when "I2" and "GND" are shorted, CCW operation when they are opened (including homing operation mode)
I3	11	Signal input 3	Motor trips when "I3" and "GND" are open.
I4	4	Signal input 4	Home detected when "I4" and "GND" are shorted.
O1	6	Signal output 1	Trip output (Normally on, and off in tripping)
O2	12	Signal output 2	In motion signal (including homing operation)

[Operation timing chart]

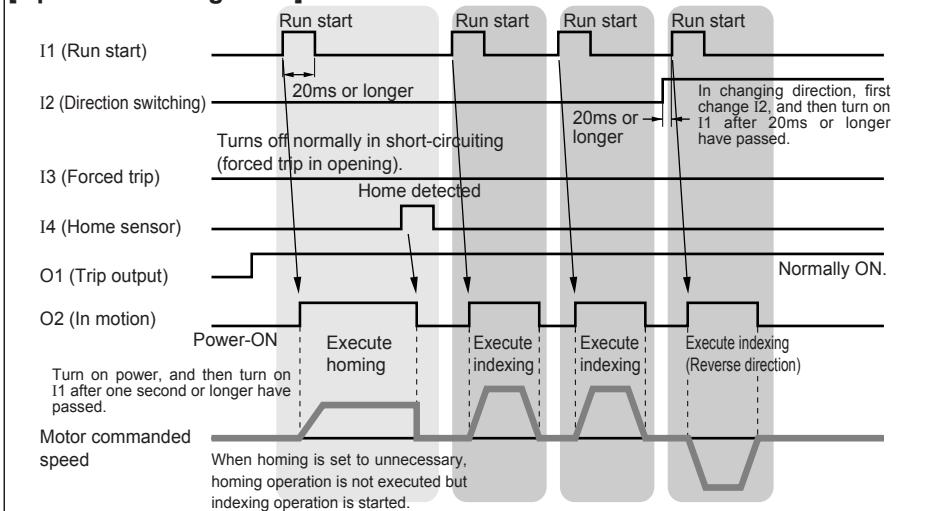

[Parameter setting] Indicates only the point changed from default setting.
(Parameter marked with * is effective after power resetting.)

Function	Parameter No. (Pr □ □)	Name of parameter	Setting	Remarks
Selection of signal function	50*	I1 function selection	8	Run start (used only for the 1st point)
	51*	I2 function selection	14	Direction switching input
	52*	I3 function selection	0	Forced trip input
	53*	I4 function selection	11	Home sensor input
	56*	I3 input logic selection	1	Changes the polarity of 3 to effective when open (forced trip in this case).
	5C	O1 function selection	0	Trip output
	5d	O2 function selection	2	In-motion signal
Homing function	40	Homing mode	0, 1, 5	Set homing in which to use home sensor.
	41	Homing direction	0, 1	Set any desired homing direction.
	42	Homing speed	200	Set any desired operation speed.
	44	Homing acceleration/deceleration time	200	Set any desired acceleration/deceleration time.
	48*	Homing function	2	Set to 1 when setting power-on position to the home.
	49	Selecting homing when motor is free	1	Set to 1 (homing is required again when tripping occurs.)
	4A	Present position overflow permission	1	Set to 1 (permits overflow).
The 1st point (indexing length)	00	The 1st target position (rotation number)	10	Set the travel distance by rotation number and pulse (one rotation per 288 pulses). When the setting does not represent proper mechanical reduction gear ratio, accumulated error occurs, which results in dislocation.
	01	The 1st target position (pulse)	0	
	02	The 1st coordinate setting	0	Set relative travel.
	03	The 1st setting speed	2000	Set any desired operation speed.
	04, 05	The 1st acceleration time/The 1st deceleration time	200	Set any desired acceleration time and deceleration time.
	06	The 1st block setting	0	Set normal operation.

<Information>

In this setting, I3 is set to forced trip when open. Connect an emergency stop switch or the like which is shorted but open at error to I3 terminal.

Please note that the motor will not run due to forced trip without such connection.

7. Example setting of motion pattern

2. Reciprocating

● When executing reciprocating run between fixed positions

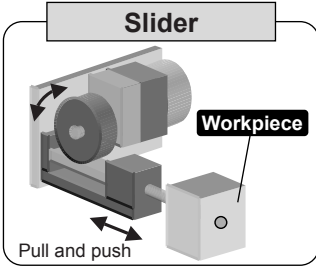

<Example of setting>

- Every time I1 is turned on, feed action → return action → feed action is repeated in turn.
- When power is on, homing operation is executed and home is set by I1.

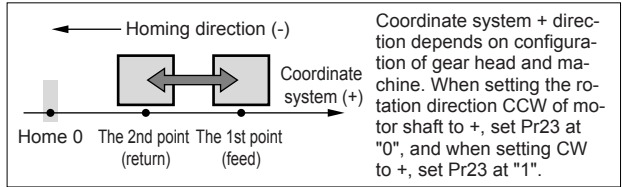

[Signal function setting]

Terminal symbol	Terminal number	Terminal name	Description of function
I1	1	Signal input 1	Operates when "I1" and "GND" are shorted (Homing operation for the first time after power-on)
I2	2	Signal input 2	Home detected when "I2" and "GND" are shorted.
I3	11	Signal input 3	Operation stops when "I3" and "GND" are shorted.
I4	4	Signal input 4	Motor trips when "I4" and "GND" are open.
O1	6	Signal output 1	Trip output (Normally on, and off in tripping)
O2	12	Signal output 2	In motion signal (including homing operation)

[Operation timing chart]

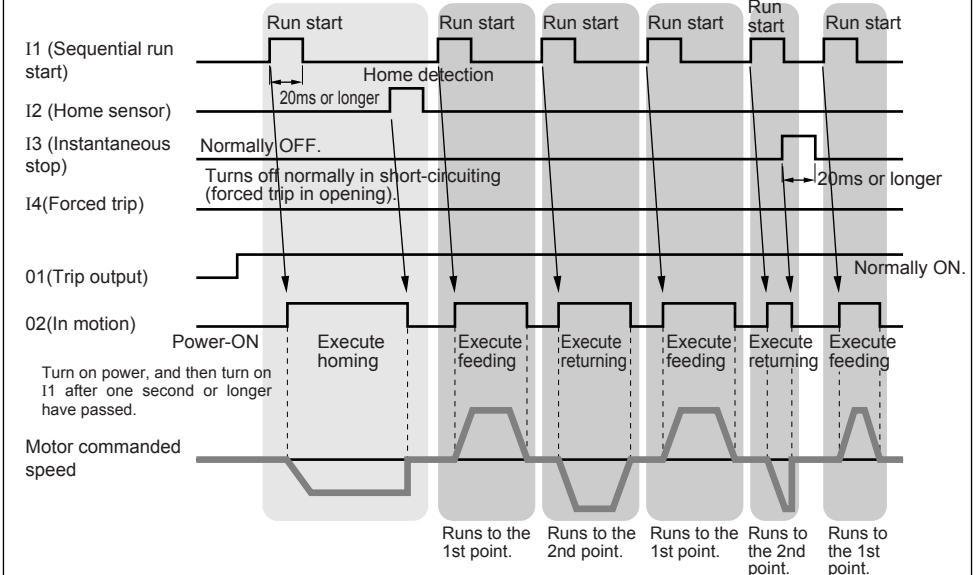

After the motor has stopped instantaneously during return operation, when I1 is turned on again, feed operation is executed from stop position. Similarly, after the motor has stopped instantaneously during feed operation, when I1 is turned on again, return operation is executed.

[Parameter setting] Indicates only the point changed from default setting.
(Parameter marked with * is effective after power resetting.)

Function	Parameter No. (Pr □ □ □)	Name of parameter	Setting	Remarks
Selection of signal function	50*	I1 function selection	9	Sequential run start
	51*	I2 function selection	11	Home sensor input
	52*	I3 function selection	1	Instantaneous stop input
	53*	I4 function selection	0	Forced trip input
	57*	I4 input logic selection	1	Changes the polarity of I4 to effective when open (forced trip in this case).
	5C	O1 function selection	0	Trip output
	5d	O2 function selection	2	In-motion signal
Homing function	40	Homing mode	0	Set homing in which to use home sensor.
	41	Homing direction	1	Set the homing direction normally to minus direction (return direction).
	42	Homing speed	200	Set any desired operation speed.
	44	Homing acceleration/deceleration time	200	Set any desired acceleration/deceleration time.
	48*	Homing function	2	Homing operation by initial I1 input when power is turned on.
	49	Selecting homing when motor is free	0	Homing is not required when tripping occurs.
	4A	Present position overflow permission	0	Overflow is not permitted because absolute travel is set.
	23*	Coordinate system setting	0, 1	Set so that homing is in minus direction.
The 1st point (feed position)	00	The 1st target position (rotation number)	10	Set the feed position coordinates.
	01	The 1st target position (pulse)	0	
	02	The 1st coordinate setting	1	Set absolute travel.
	03	The 1st setting speed	2000	Set any desired travel.
	04, 05	The 1st acceleration time/The 1st deceleration time	200	Set any desired acceleration time and deceleration time.
	06	The 1st block setting	0	Set normal operation.
The 2nd point (return position)	08	The 2nd target position (rotation number)	2	Set the return position coordinate. (Set 0 when the position is the same as home.)
	09	The 2nd target position (pulse)	0	
	0A	The 2nd coordinate setting	1	Set absolute travel.
	0b	The 2nd setting speed	2000	Set any desired travel.
	0C, 0d	The 2nd acceleration time/The 2nd deceleration time	200	Set any desired acceleration time and deceleration time.
	0E	The 2nd block setting	0	Set normal operation.
Others	22	Sequential run Maximum point number	2	Restricts the maximum point number in sequential operation. When this parameter is set to 2, whenever I1 is turned on, system operates in turn from the 1st point → the 2nd point → the 1st point

7. Example setting of motion pattern

3. Automatic reciprocating

- When executing fixed reciprocating sequence operation with single run start signal

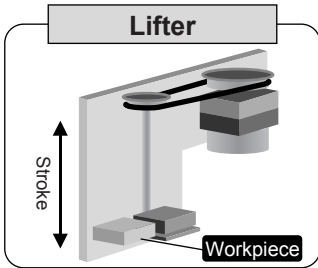

<Example of setting>

- When I1 is turned on, the unit moves to target position (feed position), waits for a specified time, and returns to original position (return position).
- When power is on, homing operation is executed and home is set by I1.

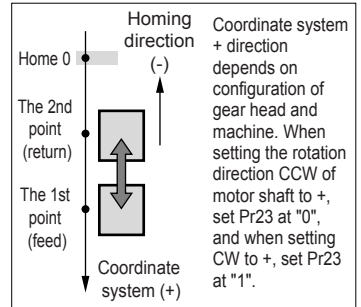

[Signal function setting]

Terminal symbol	Terminal number	Terminal name	Description of function
I1	1	Signal input 1	Operates when "I1" and "GND" are shorted (Homing operation for the first time after power-on)
I2	2	Signal input 2	Home detected when "I2" and "GND" are shorted.
I3	11	Signal input 3	Operation stops when "I3" and "GND" are shorted. (Motor does not operate during short-circuit.)
I4	4	Signal input 4	Motor trips when "I4" and "GND" are open.
O1	6	Signal output 1	Trip output (Normally on, and off in tripping)
O2	12	Signal output 2	In motion signal (including homing operation)

[Operation timing chart]

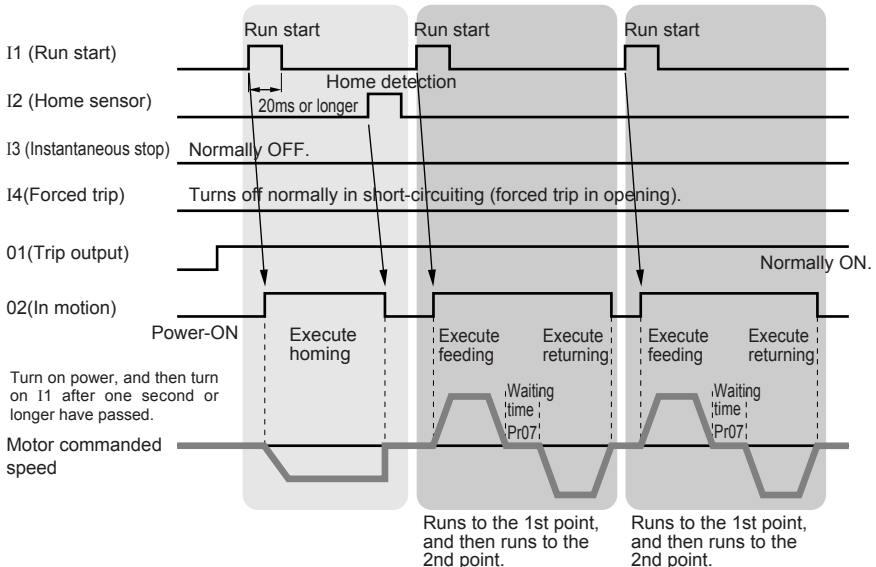

[Parameter setting] Indicates only the point changed from default setting.
(Parameter marked with * is effective after power resetting.)

Function	Parameter No. (Pr □ □ □)	Name of parameter	Setting	Remarks
Selection of signal function	50*	I1 function selection	8	Run start
	51*	I2 function selection	11	Home sensor input
	52*	I3 function selection	1	Instantaneous stop input
	53*	I4 function selection	0	Forced trip input
	57*	I4 input logic selection	1	Changes the polarity of I4 to effective when open (forced trip in this case).
	5C	O1 function selection	0	Trip output
	5d	O2 function selection	2	In-motion signal
Homing function	40	Homing mode	0	Set homing in which to use home sensor.
	41	Homing direction	1	Set the homing direction normally to minus direction (return direction).
	42	Homing speed	200	Set any desired operation speed.
	44	Homing acceleration/deceleration time	200	Set any desired acceleration/deceleration time.
	48*	Homing function	2	Homing operation by initial I1 input when power is turned on.
	49	Selecting homing when motor is free	0	Homing is not required when tripping occurs.
	4A	Present position overflow permission	0	Overflow is not permitted because absolute travel is set.
	23*	Coordinate system setting	0, 1	Set so that homing is in minus direction.
The 1st point (feed position)	00	The 1st target position (rotation number)	10	Set the feed position coordinates.
	01	The 1st target position (pulse)	0	
	02	The 1st coordinate setting	1	Set absolute travel.
	03	The 1st setting speed	2000	Set any desired operation speed.
	04, 05	The 1st acceleration time/The 1st deceleration time	200	Set any desired acceleration/deceleration time.
	06	The 1st block setting	1	Execute running to the 2nd point, after executing running to the 1st point.
	07	The 1st block timer setting	500	The 2nd point operation is started in 500ms.
The 2nd point (return position)	08	The 2nd target position (rotation number)	2	Set the return position coordinate.
	09	The 2nd target position (pulse)	0	(Set 0 when the position is the same as home.)
	0A	The 2nd coordinate setting	1	Set absolute travel.
	0b	The 2nd setting speed	2000	Set any desired operation speed.
	0C, 0d	The 2nd acceleration time/The 2nd deceleration time	200	Set any desired acceleration/deceleration time.
	0E	The 2nd block setting	0	Set normal operation.
	0F	The 2nd block timer setting	0	Ineffective because 0E is 0.

7. Example setting of motion pattern

4. Door opening/closing

• When executing reciprocating operation between 2 points

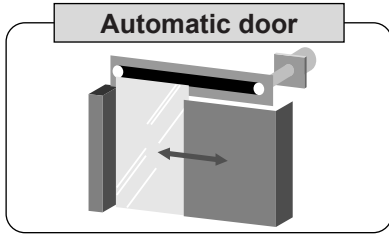

- Coordinate system + direction depends on configuration of gear head and machine. When setting the rotation direction CCW of motor shaft to +, set Pr23 at "0", and when setting CW to +, set Pr23 at "1".
- When setting the Mechanical end offset value to -144, the Home is the point which has moved 144 pulses to the + direction seen from the Mechanical end.

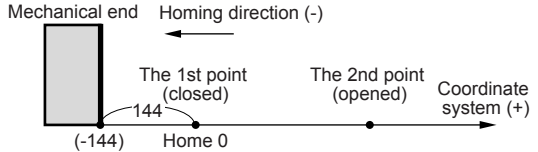

<Example of setting>

- When open/close is chosen and I1 is input, open/close operation is executed.
- When the door is stopped in any position on the way of action, opening or closing operation is enabled from such position. (It is the same when the door is moved by hand with motor disabled.)
- Use of bumping homing enables elimination of home sensor.
- Holding torque when motor is stopped can be changed.

[Signal function setting]

Terminal symbol	Terminal number	Terminal name	Description of function
I1	1	Signal input 1	Operates when "I1" and "GND" are shorted (Homing operation for the first time after power-on)
I2	2	Signal input 2	Opening (point 2) operation when "I2" and "GND" are shorted, and closing (point 1) operation when they are open.
I3	11	Signal input 3	Motor is free when "I3" and "GND" are open. (Servo lock released)
I4	4	Signal input 4	Operation is stopped when "I4" and "GND" are open. (Motor is not activated while they are open.)
O1	6	Signal output 1	Trip output (Normally on, and off in tripping)
O2	12	Signal output 2	In motion signal (including homing operation)

[Operation timing chart]

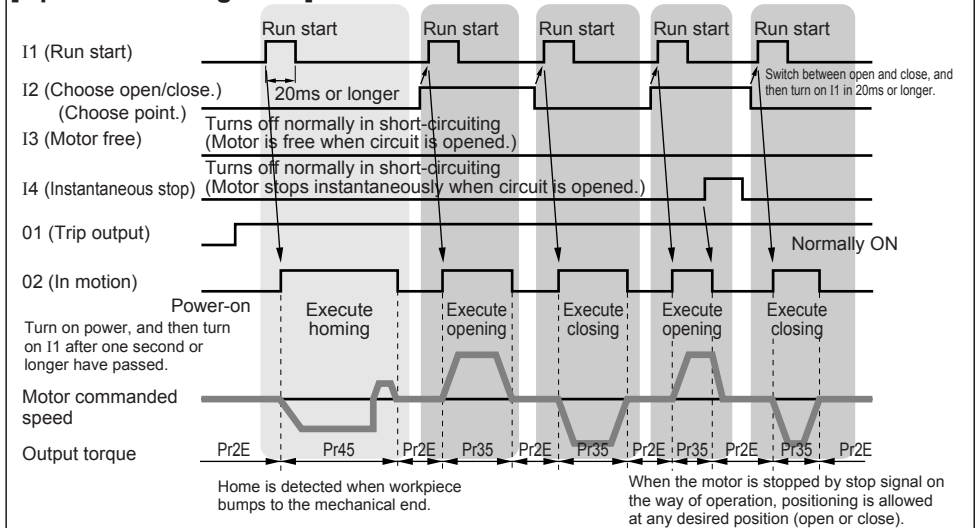

[Parameter setting] Indicates only the point changed from default setting.
(Parameter marked with * is effective after power resetting.)

Function	Parameter No. (Pr □ □)	Name of parameter	Setting	Remarks
Selection of signal function	50*	I1 function selection	8	Run start
	51*	I2 function selection	6	Point designation 1 input (choosing the 1st/2nd point)
	52*	I3 function selection	15	Motor-free input
	53*	I4 function selection	1	Instantaneous stop input
	56*	I3 input logic selection	1	Changes the polarity of I3 to effective when open (motor-free in this case).
	57*	I4 input logic selection	1	Changes the polarity of I4 to effective when open (instantaneous stop in this case).
	5C	O1 function selection	0	Trip output
	5d	O2 function selection	2	In-motion signal
Homing function	40	Homing mode	3	Bumping homing
	41	Homing direction	1	Set the homing direction normally to minus direction (closing direction).
	42	Homing speed	200	Set any desired operation speed.
	44	Homing acceleration/deceleration time	200	Set any desired acceleration/deceleration time.
	45	Bumping torque detection value	50	Torque limit during bumping homing
	46	Bumping torque detection time	100	Home is detected when torque restriction continues for one second.
	47	Home offset	-144	Set the distance from the home desired to be set to the mechanical end.
	48*	Homing function	2	When power is turned on, homing operation is executed by initial I1 input.
	49	Homing selection when motor is free	0	Homing is not required when tripping occurs.
	4A	Present position overflow permission	0	Overflow is not permitted because absolute travel is set.
	23*	Coordinate system setting	0, 1	Set so that homing is in minus direction.
The 1st point (door closing position)	00	The 1st target position (rotation number)	0	Set the door closing position coordinate.
	01	The 1st target position (pulse)	0	(Coordinate is 0 when closing position is the same as home position.)
	02	The 1st coordinate setting	1	Set absolute travel.
	03	The 1st setting speed	2000	Set any desired operation speed.
	04, 05	The 1st acceleration time/The 1st deceleration time	200	Set any desired acceleration time and deceleration time.
	06	The 1st block setting	0	Set normal operation.
The 2nd point (door opening position)	08	The 2nd target position (rotation number)	40	Set the door opening position coordinate.
	09	The 2nd target position (pulse)	0	
	0A	The 2nd coordinate setting	1	Set absolute travel.
	0b	The 2nd setting speed	2000	Set any desired operation speed.
	0C, 0d	The 2nd acceleration time/The 2nd deceleration time	200	Set any desired acceleration time and deceleration time.
	0E	The 2nd block setting	0	Set normal operation.

For automatically changing the retention torque (retention force) when door is stopped

Gain switching function	2E	Torque limit setting	100	Sets the retention torque when door is stopped. The smaller the value is, the weaker the retention force becomes.
	35	The 2nd torque limit setting	150	Maximum output torque when door is operating.
	36	Gain switching mode selection	2	Set to 0 when executing no switching.
	37	Gain switching time	100	Torque is changed in 100ms after completion of operation instruction.

8. Parameter

Overview of parameter

Motor of this series has various parameters that are used for adjusting or setting the features or functions of the motor. This section describes the purpose and function of these parameters. Ensure a full understanding of the parameters to achieve optimum operating performance.

List of parameters

Parameter No. (Pr□□)	Name of parameter	Effective after power resetting	Setting range	Default	Description	
00	The 1st target position (rotation number)		-16384 - 16383	0	Setting unit [rotation number]	You can set travel distance in rotation numbers and pulses. (288 pulses per rotation)
01	The 1st target position (Pulse)		-288 - 288	0	Setting unit [pulse]	
02	The 1st coordinate setting		0,1	1	You can select positioning system to the 1st point. 0: Relative travel, 1: Absolute travel	
03	The 1st setting speed		0 - 3000	2000	You can set the speed moving to the 1st point. Setting unit [r/min]	
04	The 1st acceleration time		1 - 30000	200	You can set time taken for reaching the 1st setting speed. Setting unit [ms]	
05	The 1st deceleration time		1 - 30000	200	You can set time taken from the 1st setting speed to stop. Setting unit [ms]	
06	The 1st block setting		0 - 2	0	0: Normal operation 1: Continuous block operation (1st point → 2nd point) 2: Combined block operation (1st point + 2nd point)	
07	The 1st block timer setting		0 - 30000	0	Enabled when you set Pr06 to "1". Start commanding of 2nd point after this setting time elapses and command of 1st point is completed. Enabled in unit of 2ms. (If you set to 1, this is rounded down and recognized as 0.) Setting unit [ms]	
08	The 2nd target position (rotation number)		-16384 - 16383	0	Setting unit [rotation number]	You can set travel distance in rotation numbers and pulses. (288 pulses per rotation)
09	The 2nd target position (Pulse)		-288 - 288	0	Setting unit [pulse]	
0A	The 2nd coordinate setting		0,1	1	You can select positioning system to the 2nd point. 0: Relative travel, 1: Absolute travel	
0b	The 2nd setting speed		0 - 3000	2000	You can set the speed moving to the 2nd point. Setting unit [r/min]	
0C	The 2nd acceleration time		1 - 30000	200	You can set time taken for reaching the 2nd setting speed. Setting unit [ms]	
0d	The 2nd deceleration time		1 - 30000	200	You can set time taken from the 2nd setting speed to stop. Setting unit [ms]	
0E	The 2nd block setting		0,1	0	0: Normal operation 1: Continuous block operation (2nd point → 3rd point)	
0F	The 2nd block timer setting		0 - 30000	0	Enabled when you set Pr0E to "1". Start commanding of 3rd point after this setting time elapses and command of 2nd point is completed. Enabled in unit of 2ms. Setting unit [ms]	

Parameter No. (Pr □□)	Name of parameter	Effective after power resetting	Setting range	Default	Description	
10	The 3rd target position (rotation number)		-16384 - 16383	0	Setting unit [rotation number]	You can set travel distance in rotation numbers and pulses. (288 pulses per rotation)
11	The 3rd target position (Pulse)		-288 - 288	0	Setting unit [pulse]	
12	The 3rd coordinate setting		0,1	1	You can select positioning system to the 3rd point. 0: Relative travel, 1: Absolute travel	
13	The 3rd setting speed		0 - 3000	2000	You can set the speed moving to the 3rd point. Setting unit [r/min]	
14	The 3rd acceleration time		1 - 30000	200	You can set time taken for reaching the 3rd setting speed. Setting unit [ms]	
15	The 3rd deceleration time		1 - 30000	200	You can set time taken from the 3rd setting speed to stop. Setting unit [ms]	
16	The 3rd block setting		0 - 2	0	0: Normal operation 1: Continuous block operation (3rd point → 4th point) 2: Combined block operation (3rd point + 4th point)	
17	The 3rd block timer setting		0 - 30000	0	Enabled when you set Pr16 to "1". Start commanding of 4th point after this setting time elapses and command of 3rd point is completed. Enabled in unit of 2ms. Setting unit [ms]	
18	The 4th target position (rotation number)		-16384 - 16383	0	Setting unit [rotation number]	You can set travel distance in rotation numbers and pulses. (288 pulses per rotation)
19	The 4th target position (Pulse)		-288 - 288	0	Setting unit [pulse]	
1A	The 4th coordinate setting		0,1	1	You can select positioning system to the 4th point. 0: Relative travel, 1: Absolute travel	
1b	The 4th setting speed		0 - 3000	2000	You can set the speed moving to the 4th point. Setting unit [r/min]	
1C	The 4th acceleration time		1 - 30000	200	You can set time taken for reaching the 4th setting speed. Setting unit [ms]	
1d	The 4th deceleration time		1 - 30000	200	You can set time taken from the 4th setting speed to stop. Setting unit [ms]	
1E	The 4th block setting		0,1	0	0: Normal operation 1: Continuous block operation (4th point → 1st point)	
1F	The 4th block timer setting		0 - 30000	0	Enabled when you set Pr1E to "1". Start commanding of 1st point after this setting time elapses and command of 4th point is completed. Enabled in unit of 2ms. Setting unit [ms]	
20	Acceleration mode		0,1	0	You can select running pattern in acceleration. 0: Linear, 1: S-Pattern (Setting common to all points)	
21	Deceleration mode		0,1	0	You can select running pattern in deceleration. 0: Linear, 1: S-Pattern (Setting common to all points)	
22	Sequential run maximum point number		1 - 4	4	You can set the maximum point number for positioning by use of sequential run signal.	
23	Coordinate system setting	○	0,1	0	0: CCW rotation in + direction, 1: CW rotation in + direction	

8. List of parameters

Parameter No. (Pr□□)	Name of parameter	Effective after power resetting	Setting range	Default	Description
28	Position loop gain (the 1st gain)		0 - 100	5	You can determine the response of position control. You need not change it normally. When it is increased, the response is improved, which is likely to cause oscillation. (The 1st gain: When gain switching is used, the 1st gain is the gain at stop.)
29	Velocity loop gain (the 1st gain)		0 - 10000	1000	You can determine the response of velocity loop. You need not change it normally. When it is increased, the response is improved, which is likely to cause oscillation.
2A	Velocity loop integration gain (the 1st gain)		0 - 10000	500	You can determine the rigidity of velocity loop. You need not change it normally. When it is increased, the rigidity is improved, which is likely to cause oscillation.
2b	Velocity feed forward gain (the 1st gain)		0 - 100	0	Set it to 0 in normal use. This is the function to forward (add) position command to speed command. When the setting is increased, the position error is decreased and response improved, which makes overshoot large. Setting unit [%]
2C	Speed detection filter (the 1st gain)		5 - 20	13	Use the default setting normally. You can set the time constant of low-pass filter of speed feedback. When the setting is made smaller, the gain can be made larger and response improved, which increases operation noise.
2d	Velocity feed forward time constant (Common to the 1st/2nd gain)		0 - 500	0	Set it at 0 in normal use. This is a filter in velocity feed forward section. When the setting is made larger, the time constant is made larger. Setting unit [ms]
2E	Torque limit setting (the 1st gain)		50 - 150	150	Output torque of motor is limited. Set it in [%] with reference to rated torque. (Torque value has no precision because torque is not controlled. Use it as an index.)
2F	Torque filter time constant (Common to the 1st/2nd gain)		0 - 500	0	You can set the time constant of primary delay filter of torque instruction. You need not change it normally. You can suppress oscillation due to insufficient rigidity of load. Setting unit [ms]
30	The 2nd position loop gain (the 2nd gain)		0 - 100	5	You can determine the response of position control. (The 2nd gain: When using gain switching, the 2nd gain is the gain in running.)
31	The 2nd velocity loop gain (the 2nd gain)		0 - 10000	1000	You can determine the response of velocity loop.
32	The 2nd velocity loop integration gain (the 2nd gain)		0 - 10000	500	You can determine the rigidity of velocity loop.
33	The 2nd velocity feed forward gain (the 2nd gain)		0 - 100	0	Set it at 0 in normal use. Setting unit [%]
34	The 2nd speed detection filter (the 2nd gain)		5 - 20	13	Use the default setting normally. You can set the time constant of low-pass filter in speed feedback.

Parameter No. (Pr □□)	Name of parameter	Effective after power resetting	Setting range	Default	Description
35	The 2nd torque limit setting (The 2nd gain)		50 - 150	150	Output torque of the motor is limited. Set it in [%] with reference to rated torque. (Torque value has no precision because torque is not controlled. Use it as an index.)
36	Gain switching mode selection		0 - 2	0	0: Fixed at the 1st gain, 1: Fixed at the 2nd gain 2: Automatic switching (In running = the 2nd gain, In standstill = the 1st gain)
37	Gain switching time		0 - 10000	50	When the gain switching mode is set to automatic switching, after the output of instruction, the 2nd gain (in running) changes to the 1st gain (in standstill) when time setting has elapsed. Setting unit [ms]
38	In-position range		0 - 16383	20	In-position signal is turned on when position error (difference between command position and actual position) is below setting. Setting unit [pulse]
39	Position error set-up		0 - 16383	144	Position error occurs when the value of position error (difference between command position and actual position) is larger than this parameter × 8 as well as parameter 3A is effective. Setting unit [pulse]
3A	Position error invalidation		0, 1	0	0: Effective, 1: Ineffective (Motor does not trip but keeps on operating.)
3E	Run-command selection	○	0, 1	0	You can select the run-command method with this parameter. 0: Command through I/O, 1: Command through RS485 (Command through I/O will be disabled except trip and sensor input)
40	Homing mode		0 - 5	0	Select homing method. 0: Home sensor homing 1, 1: Home sensor homing 2 2: Limit sensor homing, 3: Bumping homing 4: Home resetting, 5: Home sensor homing 3
41	Homing direction		0, 1	0	You can set the detection direction of home. 0: Detecting in + direction 1: Detecting in - direction
42	Homing speed		0 - 3000	200	You can set the speed in homing action. Setting unit [r/min]
43	Homing limit		0 - 16383	0	When the home cannot be detected although the motor travel distance has exceeded setting, homing error is found. (Ineffective at 0) Setting unit [rotation number]
44	Homing acceleration/ deceleration time		1 - 30000	200	You can set time taken for reaching the homing speed. Setting unit [ms]
45	Bumping torque detection value		50 - 150	50	You can limit the output torque of motor when returning to bumping home. You can set it in [%] with reference to the rated torque.
46	Bumping detection time		0 - 15000	100	You can set the detection time of bumping torque in returning to bumping home. Setting unit [ms]
47	Home offset		-16384 - 16383	0	You can set the offset from home detection position. When the home has been detected, set a value of plus and minus opposite to the desired travel direction as an offset. (When you set -100, the position traveling 100 pulses in +direction on the coordinate system is set as an home.) Setting unit [pulse]

8. List of parameters

Parameter No. (Pr □□)	Name of parameter	Effective after power resetting	Setting range	Default	Description
48	Homing function	○	0 - 2	1	0: Required, 1: Not required (Position when power is turned on is the home.) 2: When homing is not completed yet, homing operation is executed by positioning start signal.
49	Homing selection when motor is free		0, 1	0	0: When homing is unavailable after motor-free state is reset (when trip occurs, after trip is reset), positioning operation is enabled. 1: When motor is free (trip occurs), homing is required again. Note) When Pr48 is 1, setting of this parameter is ineffective.
4A	Present position overflow permission		0, 1	0	You can set operation when the present position counter of motor has overflowed (exceeded -32767 rotations). 0: Prohibited (motor trip), 1: Permitted (no motor trip) Set it to 1 for operation to allow the motor to rotate in one direction without change.
4b	Jog speed		0 - 3000	100	You can set the operation speed in jog operation. Setting unit [r/min]
4C	Jog acceleration time		1 - 30000	200	You can set time taken for reaching jog speed. Setting unit [ms]
4d	Jog deceleration time		1 - 30000	200	You can set time taken from jog speed until stopping. Setting unit [ms]
4E	Teaching speed		0 - 3000	50	You can set speed used in applying teaching function of digital keypad. Acceleration and deceleration time is the same as jog operation. Setting unit [r/min]
50	I1 function selection	○	0 - 15	8	You can assign functions to I1 through I4. 0: Forced trip, 1: Instantaneous stop
51	I2 function selection	○	0 - 15	6	2: Deceleration stop, 3: Homing start* 4: Forward jog*, 5: Reverse jog* 6: Point designation 1*, 7: Point designation 2*
52	I3 function selection	○	0 - 15	11	8: Run start*, 9: Sequential run start* 10: Trip reset, 11: Home sensor, 12: Limit in + direction, 13: Limit in - direction
53	I4 function selection	○	0 - 15	0	14: Direction switching*, 15: Motor-free *) When Pr3E is 1, this function is effective for I/O input for giving priority to RS485.
54	I1 Input logic selection	○	0, 1	0	0: Normal logic (Input is effective (ON) when connected to GND.)
55	I2 Input logic selection	○	0, 1	0	1: Reverse rotation logic (Input is effective (ON) when OPEN (open))
56	I3 Input logic selection	○	0, 1	0	Set the reverse rotation logic to the input desired to be operated on wiring break side such as forced trip (emergency stop input).
57	I4 Input logic selection	○	0, 1	0	
58	Trip reset function enable		0, 1	1	0: Disable, 1: Enable (Operation start signal longer than 1 second enables execution of trip reset.)
59	Deceleration time in instantaneous stop		0 - 30000	0	Set the deceleration time in executing instantaneous stop. Setting unit [ms]
5C	O1 function selection		0 - 5	0	You can assign functions to O1 and O2. 0: Trip output, 1: In-position,
5d	O2 function selection		0 - 5	2	2: In-motion signal (BUSY), 3: Homing completion, 4: Overload detection, 5: Torque under restriction

Parameter No. (Pr □□)	Name of parameter	Effective after power resetting	Setting range	Default	Description
5E	01 output polarity selection		0, 1	0	0: Normal logic (Output transistor ON at enabled, OFF at disabled)
5F	02 output polarity selection		0, 1	0	1: Reversed logic (Output transistor OFF at enabled, ON at disabled) When only trip output is normal logic, output transistor is off in tripping, and output transistor is on in no tripping.
60	RS485 device number	○	128 - 159	129	See page 67.
61	RS485 communication speed	○	0 - 2	2	
62	RS485 communication standard	○	0 - 11	4	
63	RS485 communication response time	○	10 - 1000	10	
64	RS485 retry times of communication	○	0 - 9	9	
65	RS485 protocol Timeout	○	1 - 255	2	
6A	Trip history clear		$\frac{\square}{\square} \frac{\square}{\square} (0)$ $\frac{\square}{\square} \frac{\square}{\square} (1)$	n0 (0)	
6b	Trip history 1		–	–	Display the latest trip.
6C	Trip history 2		–	–	Display the 2nd latest trip.
6d	Trip history 3		–	–	Display the 3rd latest trip.
6E	Trip history 4		–	–	Display the 4th latest trip.
6F	Trip history 5		–	–	Display the 5th latest trip.
77	Parameter copy function		$\frac{\square}{\square} \frac{\square}{\square}$ $\frac{\square}{\square} \frac{\square}{\square}$ $\frac{\square}{\square} \frac{\square}{\square}$ $\frac{\square}{\square} \frac{\square}{\square}$	n0	This function is only available with use of the digital keypad. See page 26.
7A	Monitor mode switching		0 - 6	0	You can choose monitor screen to be displayed first when the digital keypad is connected. 0: Rotation speed (actual speed), 1: Torque, 2: Load factor, 3: Command speed, 4: Internal DC voltage, 5: Present position (lower 5 digits), 6: Present position (rotation number)
7b	Numerator of command pulse ratio	○	1 - 20000	1	You can set the division multiplier ratio of travel distance. Change of this parameter does not affect operation speed of motor. You can set numerator : denominator = 100:1 - 1:100.
7C	Denominator of command pulse ratio	○	1 - 20000	1	
7F	For manufacturer use		–	–	It cannot be changed.

<Information>

- Pr6b, 6C, 6d, 6E, 6F, and 7F are read-only parameters. They cannot be changed.
- Parameters marked with ○ in the column of “effective after power resetting” become effective when power is turned off once and turned on again after about 10 seconds. They are not made effective just by changing.

8. List of parameters

LED display

Figures displayed on the 7 segment display of the digital keypad are shown below .

Alphanumeric	LED display
A	<i>R</i>
B	<i>b</i>
C	<i>C</i>
D	<i>d</i>
E	<i>E</i>
F	<i>F</i>
G	<i>G</i>
H	<i>H</i>
I	<i>I</i>
K	<i>k</i>
L	<i>L</i>
N	<i>n</i>
O	<i>O</i>
P	<i>P</i>
Q	<i>q</i>
R	<i>r</i>

Alphanumeric	LED display
S	<i>S</i>
T	<i>T</i>
U	<i>U</i>
V	<i>U</i>
Y	<i>Y</i>
0	<i>0</i>
1	<i>1</i>
2	<i>2</i>
3	<i>3</i>
4	<i>4</i>
5	<i>5</i>
6	<i>6</i>
7	<i>7</i>
8	<i>8</i>
9	<i>9</i>

- Example of LED display

nO	<i>nO</i>
P.PrOG	<i>P.PrOG</i>



9. Protective function

What is protective function?



- B3 Series, G type brushless motors have various protective functions. When they are activated, the motor stops under a tripping state, which turns off (opens) trip output. (Factory default)
- Trip detail is displayed only when the digital keypad (sold separately) is connected.
- State of trip and corrective actions
 - In tripped state, display of trip details appears on the 7-segment LED of the digital keypad and the motor does not work. Check the detail of trip, remove the cause, and clear the trip.

How to clear trip

When the motor is tripped, remove the cause, and clear by any of the setting procedures below:

- ① Turn off power, and turn on power after 10 seconds. (Power resetting)
- ② Press both  and  switch of digital keypad simultaneously in trip detail display mode.
- ③ Input the trip reset signal about 100ms or longer (when 10: Trip reset is set in Pr50 - 53).
- ④ When Pr58 is “1”, input the operation start signal (run start signal, sequential run start signal, jog signal, and homing start signal) about 1 second or longer.
- ⑤ Operation of communication software “PANATERM® for BL” (sold separately) also enables clearing of trip.

<Information>

- When protective functions marked with * operate in the list of protective functions described on the next page and after, trip reset by the procedure ① shown above. (Trip cannot be cleared by the procedure ②, ③, ④, and ⑤.)
- Setting change warning  (CAU) and digital keypad communication error  (E_Cn) are not saved in trip history.
- Undervoltage error  (E-LV) is not saved in trip history when power is turned off normally. It is saved only in instantaneous stop. (It is saved in trip history only when undervoltage state is established once and then voltage is recovered to normal state.)

9. Protective function

List of protective functions

Display on the digital keypad	Trip number (RS485)	Protective function	Causes	Countermeasure
<i>E - LV</i>	2	Undervoltage error (E-LV)	The motor trips when internal DC voltage (voltage of smoothing capacitor of power supply) is below specified value. Product of 100V: Approx DC100V Product of 200V: Approx DC200V	Investigate the condition of wiring and power supply.
<i>E - OV</i>	3	Overvoltage error (E-OV)	The motor trips when internal DC voltage (voltage of smoothing function of power supply) rises and exceeds specified value. Product of 100V: Approx DC200V Product of 200V: Approx DC400V	It is possible that deceleration time is too short. Set longer deceleration time. Not compatible with continuous lowering operation.
LED flashes	-	Overload warning (Electronic thermal)	When load factor exceeds specified value, the electronic thermal relay operates and monitor display flashes. It is an alarm for electronic thermal trip. 30 - 90W : 100% 130W : 80%	Reduce the load. Check the load factor in monitor mode.
<i>THr</i>	4	Overload error (Electronic thermal relay) (THr)	The motor trips when motor torque is output continuously above specified value. 30 - 90W : 115% 130W : 105%	Investigate the cause of overload, and reduce the load, change the operating pattern by making acceleration and deceleration time longer, or apply design to increase the capacity of motor.
<i>E - OS</i>	5	Overspeed error (E-OS)	The motor trips when rotation speed (actual speed) exceeds specified value. Approx 4500r/min	Ensure that the actual speed does not exceed rated rotation speed, such as overshooting by unmatching between load and gain.
<i>E - POS</i>	6	Position error (E-POS)	The motor trips when position error (difference between command position and actual position) is greater than Pr39 × 8 [pulses].	Check the parameter again and adjust gain.
<i>E - PO</i>	7	* Position error counter overflow (E-PO)	The motor trips when the position error exceeds 8388607 [pulse].	Check the parameter again and adjust gain.
<i>E - OC</i>	8	* Overcurrent error (E-OC)	The motor trips when the motor current exceeds specified current.	① Excessive acceleration/ deceleration setting is possible. Set longer acceleration/ deceleration time. ② Failure of internal circuit is possible.

Display on the digital keypad	Trip number (RS485)	Protective function	Causes	Countermeasure
<i>E - OH</i>	9	Overheat error (E-OH)	The motor trips when the temperature in control section rises above specified value. Approx 105°C	Check the ambient temperature and cooling condition of motor. Check the load factor. If the ambient temperature is low enough, and the protection occurs soon after power-on, failure is possible.
<i>E - OL</i>	10	External forced trip (E-OL)	The motor trips when external forced trip input turns on.	Turn off external forced trip input, and reset tripping.
<i>CAU</i>	11	Setting change warning (CAU)	It occurs when parameter copying function on digital keypad is completed normally. Also, when STOP key on digital keypad is pressed, the motor trips and stops.	It is not abnormal. Execute trip reset.
<i>E - 485</i>	12	RS485 communication error (E-485)	The motor trips when communication error of RS485 communication function occurs.	Check for noise problem in the vicinity. (See "Information – Communication" on page 65 for detail.)
<i>E - rU</i>	20	Command execution error (E-rU)	The motor trips when data is abnormal in executing an operation instruction (setting speed is 0, and travel distance is 32767 rotations or more).	Check the setting of parameter.
<i>E - HO</i>	21	Homing error (E-HO)	The motor trips when homing speed is 0, or when home cannot be detected although the motor shaft rotates more than parameter (Pr43) in homing operation, or when setting of sensor is abnormal	Investigate the setting of parameter, home sensor, and wiring of home sensor.
<i>E - OF</i>	22	* Present position overflow error (E-OF)	The motor trips after homing is completed, if present position exceeds ± 32767 rotations.	Check the setting of parameter. (It can be made ineffective by Pr4A.)
<i>E - LT</i>	23	Hardware limit error (E-LT)	The motor trips after homing is completed, if hardware limit sensor is detected.	Check the installation of sensor, and setting of parameter.
<i>E - Cn</i>	-	Digital keypad communication error (E_Cn)	It occurs when the digital keypad and motor cannot communicate normally. (This is a trouble on digital keypad side. It does not affect motor operation.)	It can be cleared by reconnecting the digital keypad. Make sure that digital keypad and motor are connected normally.

When any of protective functions marked with * operates, trip reset by the procedure of ① on page 45.

9. Protective function

Display on the digital keypad	Trip number (RS485)	Protective function	Causes	Countermeasure
E-UPr	90	* User parameter error (E-UPr)	Parameter data saved in EEPROM is abnormal.	Check all parameters again and set them again. If this protection works frequently, failure is possible.
E-SPr	91	* System parameter error (E-SPr)	Internal parameter data saved in EEPROM is abnormal.	Failure is possible.
E-CS	1	* Sensor error (E-CS)	The motor trips when trouble of CS sensor signal is detected.	① Malfunction due to external noise is possible. Investigate for noise source in the vicinity and eliminate such source. ② Internal circuit may be in failure.
Err	Other numbers	* System error (Err)	The motor trips when trouble of control microcomputer is detected.	
- - - -	0	Normal condition	—	—

When any of protective functions marked with * operates, trip reset by the procedure of ① on page 45.

Troubleshooting

If any trouble should be found, follow the steps below to determine the fault.

If you cannot find out the cause, we recommend that you use the digital keypad (sold separately) or communication software “PANATERM® for BL” (sold separately) to check the detail of trip. If the motor is in failure, or any part is damaged, or in another case of malfunction, contact the Panasonic partner where you bought the product.

Phenomenon	Detail of checking	Countermeasure
Motor does not rotate	Is any error in wiring.	Apply proper wiring.
	Check whether protective function is activated.	Check for tripping with digital keypad. Turn off power once, and turn on again. Reset tripping.
	(Only when the motor is connected to the digital keypad) Check whether 7-segment LED of on the digital keypad is lighted up.	If the LED is off when power is input to the motor, failure is possible. Contact us for repair.
	Check whether the voltage of power input line is normal.	Check the supply voltage and voltage described on motor nameplate.
	Check whether run start signal is input.	Check wiring.
	Homing is not executed yet.	First set the parameter for homing operation and execute homing operation.
	Check whether target position of each point of parameter is set.	Set the target position.

Phenomenon	Detail of checking	Countermeasure
Motor stops during the run.	Check whether protective function is activated.	Overload on the motor is possible. Reduce the load, increase the capacity of motor, or increase the gear reduction ratio.
Motor stops during deceleration.	Check whether the inertia of load is too large.	Regenerative overload error was activated. Make the inertia smaller. Once turn off power and turn on again for clearing trip. Increase the deceleration time with digital keypad.
Large vibration or noise.	Output shaft of motor (gear head) and shaft of load are not aligned.	Check the connection between the output shaft of motor (gear head) and the load.
	Motor and gear head are not assembled correctly.	Check the assembling condition between motor and gear head, and their combination, and assemble them properly.
	Damage to gear head or bearing.	Contact us for repair.
	Gain is not adjusted properly.	Gain must be adjusted. Lower the setting.
Motor rotates reversely.	Check whether the setting of rotation direction (parameter) is wrong. Rotation direction of motor and that of gear head output shaft are reverse with some gear reduction ratio of gear head.	Check the setting of parameter. Check the gear reduction ratio. Check the rotation direction. See the list of permissible shaft torque on page 13.
Rotation speed is unstable during operation (actual speed).	Check whether the load fluctuates greatly.	Reduce the fluctuation of load. Increase the capacity of motor. Increase the gear reduction ratio.
Positioning accuracy is not precise.	Check whether the setting of parameter is wrong.	Adjust the parameter of target position of each point.
		Check the parameter of coordinate setting (relative and absolute).
Home position shifts.	Chattering of home sensor	Check wiring.
	Homing speed is too fast.	Reduce the setting speed with parameter.
Motor is too hot.	Start and stop are repeated frequently.	Check by display of load factor. Use within 80% is recommended.
Parameter does not change.	Check whether parameters are changed which are effective after resetting.	Turn off power once, and turn on again for resetting. See the list of parameters.
Rotation speed (actual speed) and target position are not as expected.	Check whether the setting of parameter is wrong.	Check the detail of parameter setting. See the list of parameters.

10. Conformance to EC directives and UL standards

EC Directives

The EC directives apply to all such electronic products as those having specific functions and directly sold to general consumers in EC countries. These products are required to meet the EC unified standards and to be furnished with CE marking.

Our brushless motor meet the EC Directives for Low Voltage Equipment so that the machine or equipment comprising our AC servo can meet relevant EC Directives.

EMC Directives

Our brushless motor can meet EMC Directives and related standards. However, to meet these requirements, the systems must be limited with respect to configuration and other aspects, e.g. the installation and some special wiring conditions must be met. This means that in some cases machines and equipment comprising our servo systems may not satisfy the requirements for wiring and grounding conditions specified by the EMC Directives. Therefore, conformance to the EMC Directives (especially the requirements for emission noise and noise terminal voltage) should be examined based on the final products that include our system.

Applicable standard

	Applicable standard		Installation condition
UL	UL1004	Electric motor	—
	UL508C	Power conversion equipment	
CE	EN50178	Electronic equipment for use in power installation (low voltage directive)	Overvoltage category II Class I equipment Pollution degree 2 (circuit assembly)
	EN60034-1	Rotating electrical machines (low voltage directive)	
	EN55011	Industrial, scientific and medical (ISM) radio-frequency equipment - radio disturbance characteristics - Limits and methods of measurement	
	EN61000-6-2	Electromagnetic compatibility (EMC)	
	IEC61000-4-2	Electrostatics Discharge Immunity Test	
	IEC61000-4-3	Radio Frequency Electromagnetic Field Immunity Test	
	IEC61000-4-4	Electric high-speed transition phenomenon/burst immunity test	
	IEC61000-4-5	Lightening Surge Immunity Test	
	IEC61000-4-6	High Frequency Conduction Immunity Test	
	IEC61000-4-11	Instantaneous Outage-Immunity Test	

IEC: International Electrotechnical Commission

EN: Europaischen Normen

EMC: Electromagnetic Compatibility

Configuration of peripheral equipment

Power supply	<ul style="list-style-type: none"> • 100V system: Single-phase 100V–120V±10%, 50/60Hz • 200V system: Single-phase/3-phase 200V–240V±10%, 50/60Hz • Use the equipment under the environment of overvoltage category II specified by IEC60664-1. In order to obtain overvoltage category III, insert a transformer conforming to EN standard or IEC standard to the input of brushless motor. • Use an electric wire size suitable to EN60204-1.
Fuse breaker	Be sure to connect a specified no-fuse breaker certified by IEC standard and UL, or a fuse certified by UL between power supply and noise filter. Observance of this condition allows conformance with UL508C (file No. 164620) and UL1004 (file No.166557).
Noise filter	When installing one noise filter at the power supply for more than one brushless motor used, contact the manufacturer of noise filter.
Surge absorber	Install a surge absorber on the primary side of noise filter. However, in performing the voltage resistance test of machine and equipment, be sure to remove the surge absorber; otherwise, the surge absorber may be ruptured.
Grounding	Be sure to connect the protective grounding wire of brushless motor (green/yellow) and protective earth of the equipment (PE) for preventing electric shock. Do not tighten protective earths together but connect them individually.

Wiring of peripheral equipment

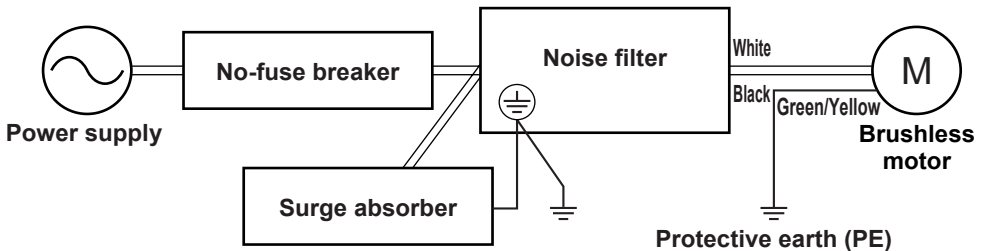

10. Conformance to EC directives and UL standards

List of compatible peripheral equipment

Part name	Optional part number	Manufacturer's part No.	Manufacturer
Noise filter	DV0P3611-5	SUP-EQ5-ER-6	OKAYA ELECTRIC IND. CO., LTD.
Surge absorber	DV0P1450	R.A.V-781BXZ-4	OKAYA ELECTRIC IND. CO., LTD.

Contact: OKAYA ELECTRIC IND. CO., LTD. Japan +81-3-3424-8120

Noise filter

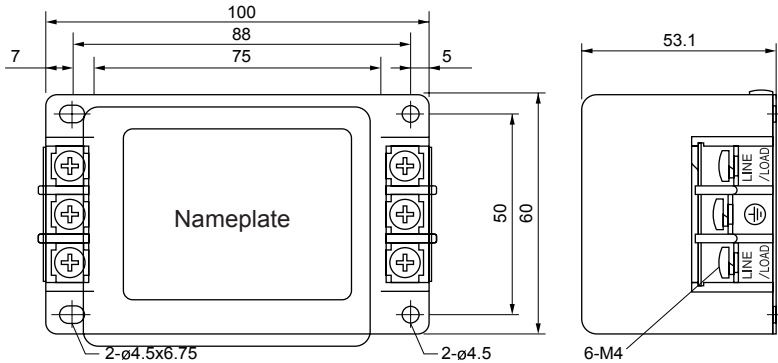

Surge absorber

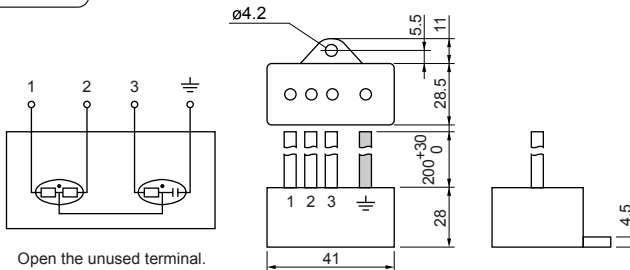

Recommended circuit breaker

Made by Sanken Airpax Co., Ltd. : Type IELH-1-11-63-5A-M

(Rated current 5A, Cutoff characteristics DELAY63)

■ Recommended cutoff characteristics: DELAY61-63

Contact: Sanken Airpax Co., Ltd.

<http://www.sanken-airpax.co.jp/epage.html>

11. Appendix - Detail of parameters

Detail of parameter

Operation setting

● Positioning operation

This motor can save positioning information for a maximum of 4 points (the 1st to the 4th point), and allows operation by use of I/O interface. Travel distance, speed setting, acceleration time, deceleration time, and coordinate (relative travel/absolute travel) can be set for each point. Further, setting block operations allows operation to change speed setting and position allowing continuous movements of position to position with a single operation command.

Homing must be completed for executing positioning operation. (It is possible to make homing unnecessary by Pr48.) If operation command run such as operation start is input without homing completed, the run command is ignored. If limit sensor is detected after completion of homing, hardware limit error $\boxed{E-LT}$ (E-LT) is found. Travel distance is the addition of rotation number and pulse of motor shaft. One rotation of motor shaft corresponds to 288 [pulses], therefore the travel distance is the rotation number x 288 + pulse [pulses]. e.g.) When 1 [rotations] and 144 [pulses] are set at the target position, the travel distance is 432 pulses, this represents a travel distance of 1.5 rotations. Negative values can also be set on the pulse/value. When 2 [rotations] – 144 [pulses] is set, it also represents the same travel distance of 1.5 rotations.

Single positioning command allows up to 32767 rotations at the maximum on the motor shaft. When operation command is above 32767 rotations + 1 pulse, command execution error $\boxed{E-rU}$ (E-rU) is found.

This motor is provided with two types of positioning instruction function, i.e. point designation run and sequential run. Operation to a designated point is executed by point designation run. In sequential run, point number is automatically updated (such as 1 → 2 → 3 → 1 ...) whenever an run signal is input.

① Point designation run (using run start signal and point designation signal)

Set Pr50 - 53 as follows and assign the function of signal input. Of signal inputs 1 - 4 (I1 - I4), set the parameter used for run start at "8", the input used for point designation 1 at "6", and the input parameter used for point designation 2 at "7". When point designation is not assigned to signal input, such signal is always considered to be off. (For example, when the 3rd and 4th point are not designated, it is not required to assign point designation 2.) When run start is input after designation of point, the motor moves to any desired point.

	Point designation 1	OFF	ON
Point designation 2			
OFF		Runs to the 1st point.	Runs to the 2nd point.
ON		Runs to the 3rd point.	Runs to the 4th point.

11. Appendix - Detail of parameter

② Sequential run (using sequential run start signal)

Set Pr50 - 53 as follows, and assign the function of signal input.

Of signal inputs 1 - 4 (I1 - I4), set the input parameter used for run start at "9" (sequential run start).

Positioning point number is incremented by one whenever the sequential run start signal is turned on. (When homing is completed, the initial run start point is always the 1st point.)

The maximum of run point can be set by Pr22.

e.g.) When Pr22 is 3, the motor runs in the order: the 1st point → the 2nd point → the 3rd point → the 1st point → ... whenever run command is input.

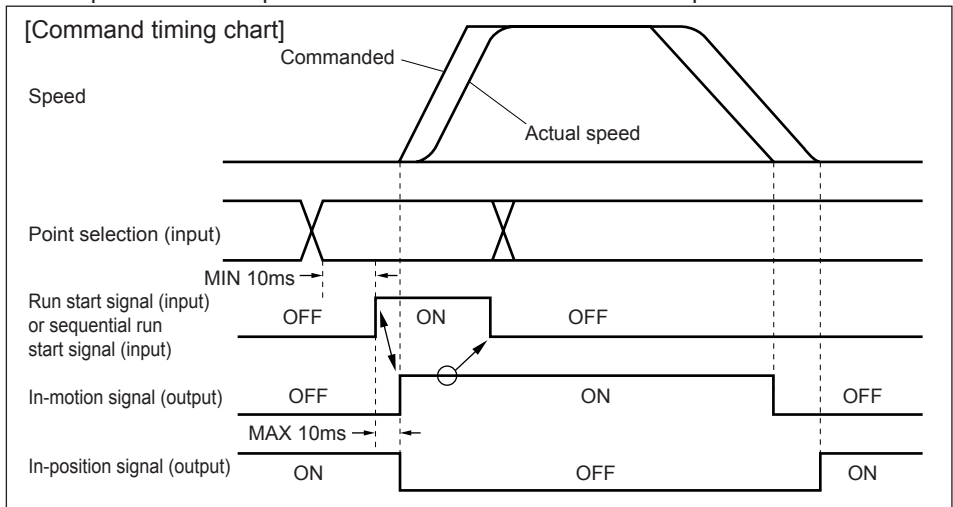

- (1) Choose a point number for point designation run. Point designation is not required (made ineffective) in sequential operation.
 - (2) Set the run start signal at (ON (Default setting: ON when shorted to GND)). It activates operation.
 - (3) Make sure that in-motion signal (BUSY) is on, and then return the run start signal to off. (Assign the function of in-motion signal to signal output 01 or 02 by Pr5E and 5F.) Alternatively, turn on the run start signal, and turn it off in 20msec. Changing the next point designation number for positioning operation at this point causes no problem.
 - (4) When positioning operation is completed, in-motion signal (BUSY) returns to off. (If the run start signal is not off, positioning when operation is completed, in-motion signal still remains on.) In-position signal, after completion of command output, turns on when position error (difference between command position and actually reached position) is below setting of Pr38.
- Operation instruction can be given to the motor only when in-motion signal is off.

● Block operation

This motor allows continuous positioning to more than one point by single operation instruction (continuous block operation) or changing the speed setting on the way of operation (combined block operation) when block operation is set.

① Continuous block operation

Continuous block run is executed by setting the block setting parameter (Pr06, 0E, 16, and 1E) at “1”, and giving run start command by any procedure.

When command output of point is completed, command output of the following points is started when set waiting time (Pr07, 0F, 17, and 1F) has elapsed.

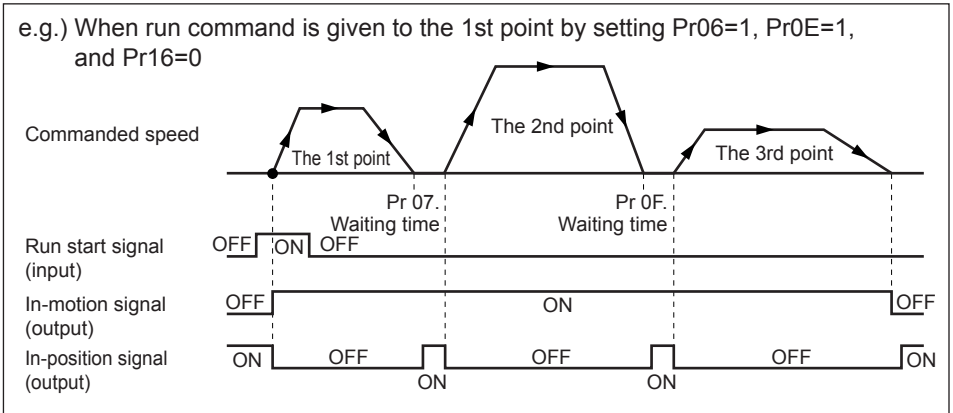

- When block setting parameters (Pr06, 0E, 16, and 1E) are all set to “1”, single run start command allows the motor to keep moving in the order: the 1st point → the 2nd point → the 3rd point → the 4th point → the 1st point → ... until stop signal is input.
- Changing the value of Pr22 “Sequential run maximum point number” allows the motor to keep moving in the order: the 1st point → the 2nd point → the 3rd point → the 1st point → ... even when block setting parameters are all “1” (when Pr22 = 3).

② Combined block operation

When block setting parameter (Pr06 and 16) is set to “2”, and run start command is given to the 1st or 3rd point in any procedure, combined block operation of the 1st point + 2nd point (or the 3rd point + the 4th point) is executed.

Positioning operation completion position in combined block operation is determined by the 2nd point (or the 4th point). Position for changing speed setting is determined by the 1st point (or the 3rd point).

Coordinate setting of each point can be either by relative travel or absolute travel.

11. Appendix- Detail of parameter

When the 2nd point (or the 4th point) which is the positioning operation completion position is set by relative travel, coordinate is calculated by target position of the 1st point (or the 3rd point), and by run start position in the case of absolute travel.

When the 1st point (or the 3rd point) is set by absolute travel, if the motor passes the position designated by parameter, the motor speed changes to the speed set by the 2nd point (or the 4th point), and the motor runs to the target position. In relative travel, the motor runs by the speed designated at the 1st point (or the 3rd point) for the distance set by the 1st point (or the 3rd point) from run start, and then the motor speed changes to the speed designated at the 2nd point (or the 4th point) and the motor runs to the target position.

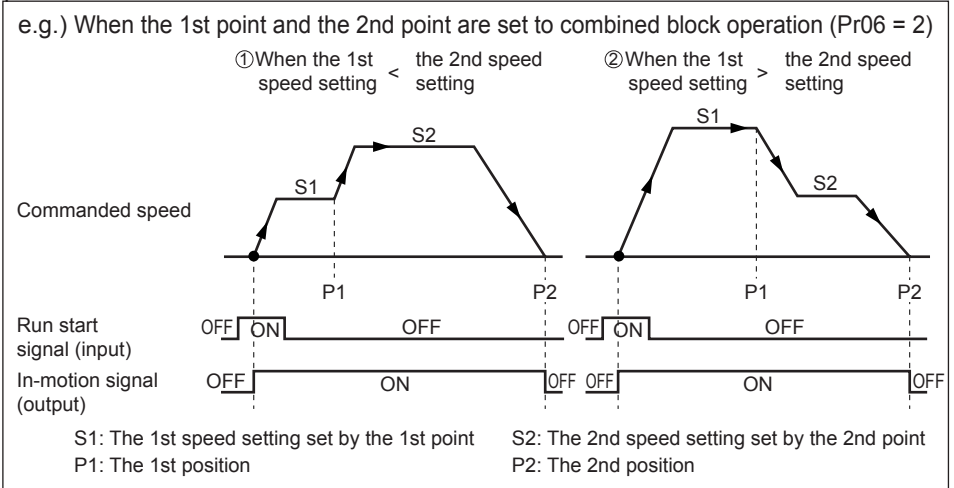

- When the 1st point position > the 2nd point position (when the target position is closer than the position to change speed setting (P1)), the motor runs to the 2nd point position at the 1st speed setting and positioning operation is completed.
- When the motor run start position has already passed the position of the 1st point such as when the motor is stopped halfway (or when the operation direction to the 1st point is different from that to the 2nd point), the motor runs to the position of the 2nd point at the 2nd speed setting, and positioning operation is completed.
- During combined block operation, data of the 1st point is applied to the setting of acceleration and deceleration time. Setting at the 2nd point is made ineffective, and the motor operates with acceleration and deceleration time set at the 1st point.
- In combined block operation, acceleration and deceleration pattern is fixed to linearity. (It is the same when the motor runs to the target position at a constant speed.)
- In combined block operation (status where the 1st block setting is "2"), when the 2nd point positioning command is executed, command execution error $\boxed{E - r U}$ (E-rU) is

found.

- When using block setting “2” and “1” together, it is enabled by setting the block setting parameter at “1” and setting the block timer at the 2nd point. (Operation at the 3rd point is started after completion of combined block operation at the 1st point + the 2nd point.)

● Jog operation

The motor runs in one direction at a specified speed as long as the signal is on. Jog operation is allowed even when homing is not completed.

Set Pr50 - 53 as follows, and assign the function of signal input.

Of signal inputs 1 - 4 (I1 - I4), set the input used for forward jog operation instruction at “4”, and the input used for reverse jog operation instruction at “5”.

The motor runs in specified direction as long as specified input signal is on.

When the input signal is turned off, the motor reduces its speed and stops.

See Pr4b - 4d for parameters relating to jog operation.

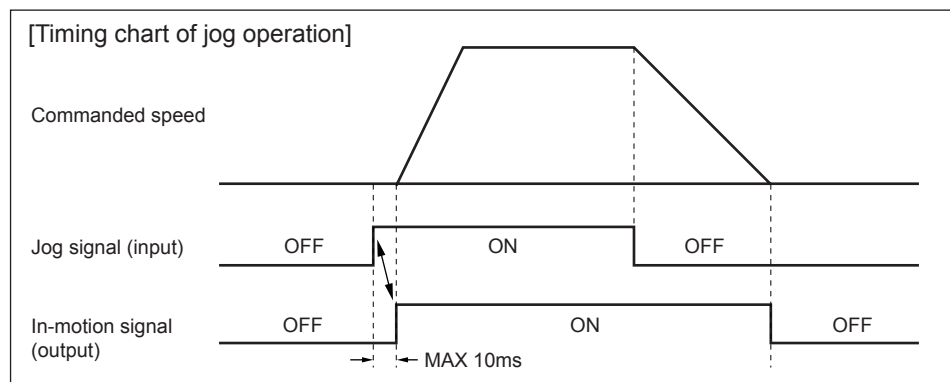

- (1) Change the jog start signal from contact-off to the status of connection to GND (on). It activates operation.
 - (2) When the jog start signal is returned to off, the motor starts speed reduction.
 - (3) When operation is completed, the transistor of in-motion signal (BUSY) returns to off.
- Operation instruction can be given to the motor only when in-motion signal is off.
 - In jog operation, setting of Pr20 is applied to acceleration and deceleration pattern (linear and S-letter) as for acceleration. In deceleration, the pattern is linear irrespective of setting of Pr21.

11. Appendix - Detail of parameter

● Homing operation

In order to establish the reference position of motor, homing operation is always required for positioning operation.

In applications where homing operation is not required, set Pr48 at “1”, then the position where power is turned on is assumed to be the home (0), by which positioning operation is enabled. After completion of homing, when the limit sensor in motor operation direction is detected, hardware limit error $\boxed{E-LT}$ (E-LT) is found.

When you use the relative travel command in positioning, positioning might shift after the motor trip reset, or at positioning after turning the motor-free signal from OFF to ON. If you find any problem in such a use, set Pr49 at “1” to apply “homing operation required again when motor is free”.

This motor support the following homing operation.

Parameter 40	Homing name	Description
0	Home sensor homing 1	Edge of home sensor is detected to be set to the home.
1	Home sensor homing 2	When the home sensor is on at the homing command, corresponding position is set to the home. In any other case, operation the same as home sensor homing 1 is executed.
5	Home sensor homing 3	When reversing is not desired in homing (only for rotation system)
2	Limit sensor homing	Edge of limit sensor is detected and set to the home.
3	Bumping homing	Mechanical end is detected and set to the home.
4	Home resetting	Present position is reset to be the home.

In order to execute homing operation, set Pr50 - 53 as follows to assign the function of signal input.

Assign one of signal inputs 1 - 4 (I1 - I4) to the input used for homing start signal. (Set Pr52 at “3” for I3.) Be sure to assign the function required for respective homing to the signal input. Unnecessary sensors (functions) need not be assigned if not required.

When Pr48 is set to “2”, it is enabled to execute homing operation with run start signal (run start and sequential run start) when homing is not completed.

See Pr 40 - 49 for parameters relating to homing operation. Set the homing speed as low as possible in order to improve accuracy in homing.

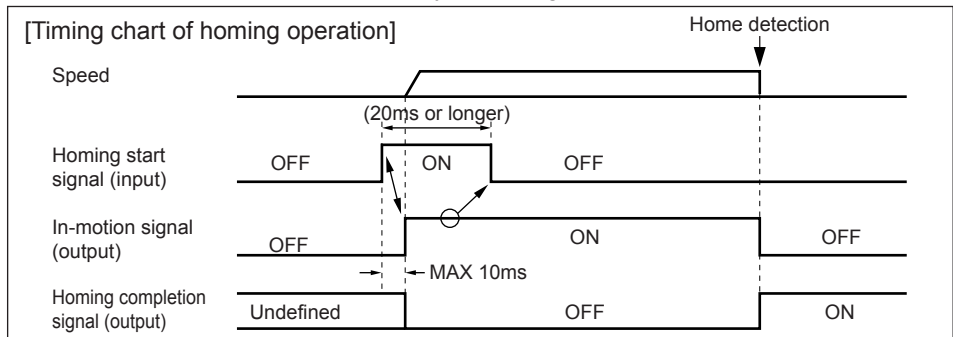

- (1) Change the homing start signal (or run start signal (when Pr48 is 2)) from contact-off to the status of connection to GND (on). It activates operation. Even when homing has been completed, if homing is started, the homing completion signal turns off.
- (2) Make sure that in-motion signal (BUSY) is on and return the homing start signal to open status. Alternatively, enable the homing operation return start signal for a minimum of 20msec.
- (3) When operation is completed, in-motion signal (BUSY) returns to off. (If the homing start signal is not off, even when operation is completed, the in-motion signal is still on.) Also, when homing is completed normally, the homing completion signal turns on.
 - Run signal can be given to the motor only when in-motion signal is off.
 - In homing operation, setting of Pr20 is applied to acceleration and deceleration pattern (linear and S-shape) as for acceleration. In deceleration, the pattern is linear irrespective of setting of Pr21.

Home sensor homing 1 (Pr40 = 0), Home sensor homing 2 (Pr40 = 1)

e.g. 1: When "Pr41 Detects the homing direction in – direction" is set.

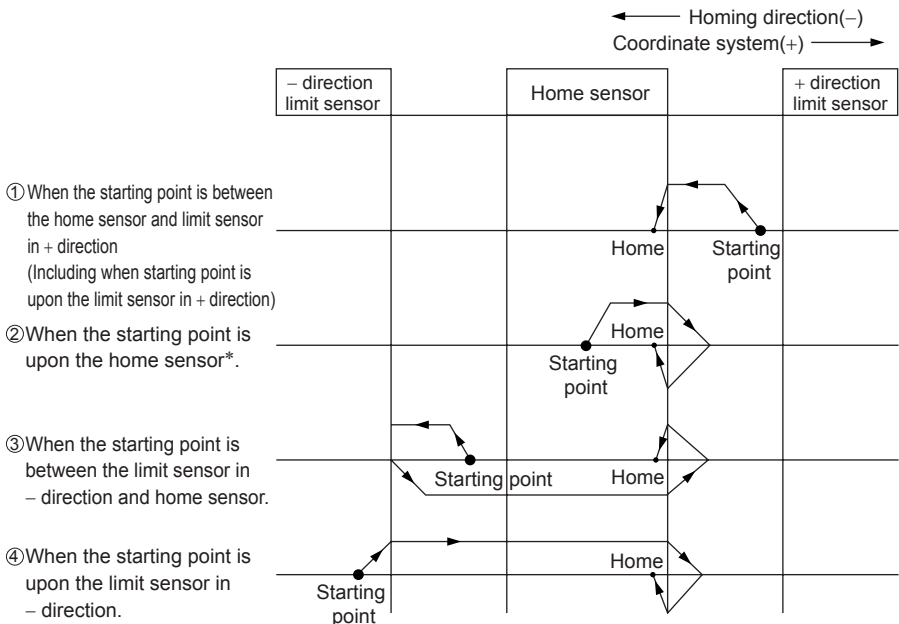

* In the case of home sensor homing 2, when homing operation is executed upon the home sensor of 2, the motor is not activated but the position is set to the home, and homing operation is completed.

11. Appendix – Detail of parameter

e.g. 2: When homing consists of home sensor only.

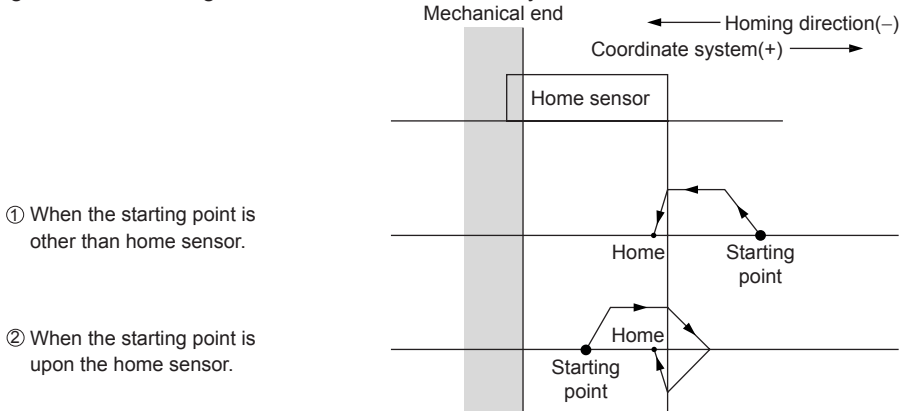

Be sure to set the homing direction so that homing operation is executed in the direction where home sensor is located. In this example, set "Pr41 Detects the homing direction in - direction".

Home sensor homing 3 (Pr40 = 5) (Only for rotation system)

e.g. : When "Pr41 Detects the homing direction in + direction" is set

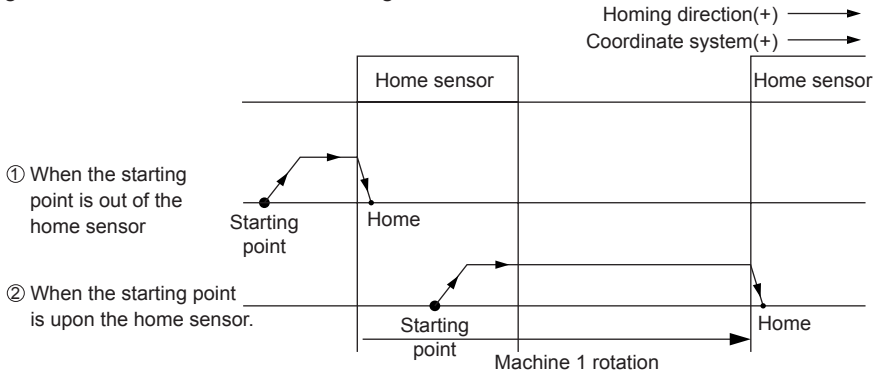

Set this option when the machine belongs to rotational system and reversing is not desired.

In this mode, the motor always runs in the set homing direction, and the edge of home sensor is detected and set to the home. (In this case, runs in + direction only with no reversing.)

If a limit sensor in running direction is detected during homing, homing error E-HO (E-HO) is found.

Limit sensor homing (Pr40 = 2)

e.g. : When "Pr41 Detects the homing direction in - direction" is set.

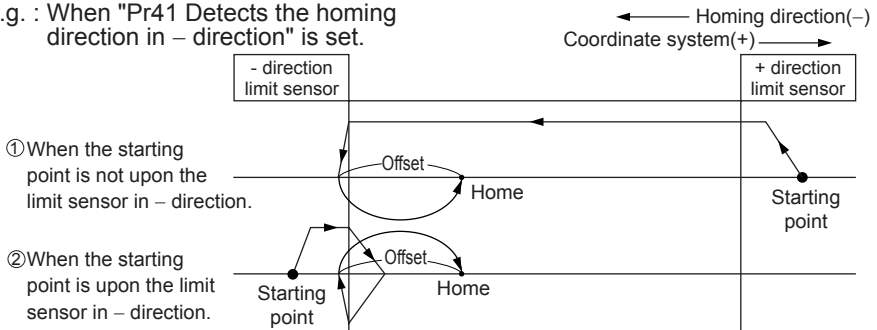

In using this mode, the motor at the home position is within the limit sensor, therefore be sure to set the home offset (Pr47). When the offset is set to -100, the point which is moved 100 pulses in + direction as viewed from the edge of limit sensor in - direction is set to the home. (Set a value of plus and minus opposite to the desired travel direction as an offset.)

Bumping homing (Pr40 = 3)

e.g. : When "Pr41 Detects the homing direction in - direction" is set.

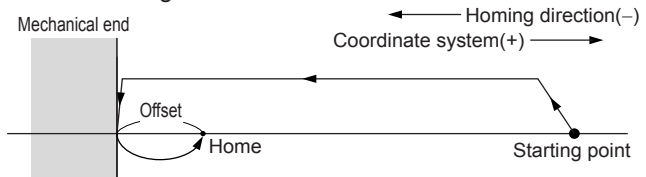

When the torque value has exceeded the setting (Pr45) for preset time (Pr46), homing is completed.

During operation of this mode, the value of torque limit is restricted by bumping torque detection value (Pr45). In bumping homing operation, when limit sensor in operation direction is detected, homing error $\boxed{E-H0}$ (E-H0) is found.

In using this mode, the motor at the home position is in contact with the mechanical end, therefore be sure to set the home offset (Pr47). (Set a value of plus and minus opposite to the desired travel direction as an offset.)

<Caution>

In setting the bumping homing, too high homing speed or too large torque limit causes excessive shock, which may give damage to the machine or motor. Restrict the homing speed to approx 100 r/min on motor shaft, and bumping torque limit below rated motor torque.

Home resetting (Pr40 = 4)

In this mode, the position where homing start signal is input is set to the home (0 position), and the motor does not run but homing operation is completed.

11. Appendix – Detail of parameter

Signal Input and Signal Output Choosing Function

● Signal input choosing function

Function can be assigned to signal input I1 - I4 by Pr50 - 53.

Function number	Assignment function	Description of function
0	Forced trip	When preset signal input is turned on, the motor executes external forced trip $\boxed{E - OL}$ (E-OL). When external forced trip is executed, in order to activate the motor again, reset trip and then input the run command.
1	Instantaneous stop	When preset signal input is turned on, the motor reduces speed and stops in deceleration time set by Pr59 "Deceleration time in instantaneous stop". (Linear deceleration) When the setting is "0", the command is an instantaneous stop. (However, the motor may operate for accumulated pulses of command.) Run command cannot be given to the motor with stop signal turned on. Be sure to turn off stop signal in operation.
2	Deceleration stop	When preset signal input is turned on, the motor reduces speed and stops in deceleration time set at the start of motor operation (deceleration time set on each point in positioning operation, jog deceleration time in jog operation, and homing acceleration and deceleration time in homing). (Linear deceleration) Run command cannot be given to the motor with deceleration stop signal turned on. Be sure to turn off deceleration stop signal in operation.
3	Homing start	When this signal is turned on, homing operation is started.
4	Forward jog	The motor runs at jog speed in + direction as long as this signal is on.
5	Reverse jog	The motor runs at jog speed in - direction as long as this signal is on.
6	Point designation 1	Point designation 1
7	Point designation 2	Point designation 2
8	Run start	Motor is positioned at any point designated by point designation 1 and 2.
9	Sequential run start	Motor is positioned at the following point every time the signal is input.

Function number	Assignment function	Description of function
10	Trip reset	The trip is reset (trip cleared) when set signal input is turned on approx 100ms or longer. When Pr58 is set at "1", trip can be reset by turning on operation start signal (run start, sequential run start, forward jog, reverse jog, and homing start) for approx 1 second or longer. Be sure to remove the cause before trip reset.
11	Home sensor	Make wiring so that the signal is turned on when home sensor is detected.
12	Limit in + direction	Make wiring so that the signal turn on any time. If the input is turned off, the motor does not run in + direction. Limit function is disabled when this signal is not used.
13	Limit in - direction	Make wiring so that the signal turn on any time. If the input is turned off, the motor does not run in - direction. Limit function is disabled when this signal is not used.
14	Direction switching	Direction of homing, jog, and positioning command is all reversed while this signal is turned on.
15	Motor-free	When preset signal is turned on, the motor is free to rotate. If the motor-free signal is turned on during motor operation, the load may keep moving through inertia and hit mechanical stops. In addition, it is impossible to give run command to the motor with motor-free signal turned on. Be sure to turn off the signal in running. In switching the motor-free signal from on to off, input the run start signal after 100ms or longer the motor-free signal is turned off. In the case where relative travel command is used for positioning operation, if positioning operation is executed after turning on and then off the motor-free signal, positioning might shift. If this is inconvenient to your application, set Pr49 to "1. homing operation is required again when motor is free". Then, homing operation is required again for executing positioning operation when motor-free condition (or trip) is cleared.

- When more than one signal input is assigned to the same function, the signal is made effective when any one signal is input.
- Logic of signal input can be changed by setting the polarity change parameter (Pr54 - Pr57) (Set an input desired to be operated on disconnected side of wiring such as 0: Normal logic (Input is effective in connecting with GND), 1: Inverted logic (Input is effective by OPEN), Inverted logic is forced trip (emergency stop input).
- Parameters above (Pr50 - 57) are made effective after power is turned on again.

11. Appendix — Detail of parameter

● Signal output selection function

Function can be assigned to signal output 01 and 02 by Pr5C and 5d

Function number	Assigned function	Description of function (standard logic)
0	Trip output	This signal is normally on, and turns off when tripping occurs.
1	In-position	This signal turns on when motion command is completed as well as position error is within Pr38.
2	In-motion (BUSY)	This signal turns on during run command. (Run start signal is not accepted as long as this signal is on.)
3	Homing completion	This signal turns on when homing operation is completed.
4	Overload detection	This signal turns on when torque above 100% is output.
5	Torque under restriction	This signal turns on as long as torque is restricted.

· Logic of signal output can be inverted by polarity choosing parameter (Pr5E and 5F).

Gain switching function

You can switch the gain parameter automatically while the motor is in run-command and is at standstill. During the automatic gain switching (Pr36 = 2), the 2nd gain is applied while the motor is in run-command, and the 1st gain is applied while the motor is at standstill.

With this gain switching function, you can change the holding torque at the motor standstill by setting different values of torque limit between 1st and 2nd gain.

Parameter name	Parameter number		Supplement
	The 1st gain (when stopped)	The 2nd gain (during instruction)	
Position loop gain	28	30	Determines the response of position control.
Velocity loop gain	29	31	Determines the response of velocity loop.
Velocity loop integration gain	2A	32	Determines the rigidity of velocity loop.
Velocity feed forward	2b	33	Function to forward (add) position instruction to commanded speed
Speed detection filter	2C	34	Sets the time constant of low-pass filter of speed feedback.
Velocity feed forward time constant	2d		Filter in velocity feed forward
Torque limit	2E	35	Limits the output torque of motor.
Gain switching mode selection	36		0 : The 1st gain fixed, 1 : The 2nd gain fixed, 2 : Automatic switching
Gain switching time	37		Changes to the 1st gain in the time set by parameter after command output is completed. Unit [ms].

Operation is as follows when Pr36 is “2”.

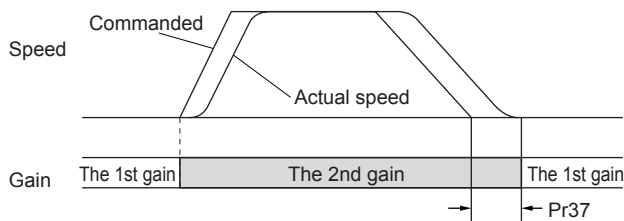

Note) It is not allowed to set switching time in changing from the 1st gain to the 2nd gain in the start of operation.

11. Appendix — RS485 Communication

Communication

Overview of Communication

With the upper host controller, which can be connected with 31 brushless motors at the maximum via serial communication conforming to RS485, enables the following:

- ① Rewriting parameters
- ② Browsing and clearing status and history of trip condition
- ③ Monitoring control status including present position, status, I/O, etc.
- ④ Start and stop of motor

[Advantage]

- It is allowed to write parameters by one operation from host controller in startup of the machine.
- Operating condition of the machine can be displayed, which improves serviceability.

Connection of Communications Line

Connect one host controller with more than one brushless motor via RS485 communication, and set the device number of each brushless motor (Pr60) at 81h (129) - 9Fh (159). Set the device number for the host as 01h (1) - 1Fh (31).

<Note>

Device number is set at 81h (129) in default setting. When connecting more than one brushless motor via RS485, be sure to change the device number beforehand with the digital keypad or communication software "PANATERM® for BL" (sold separately).

[Example of connection]

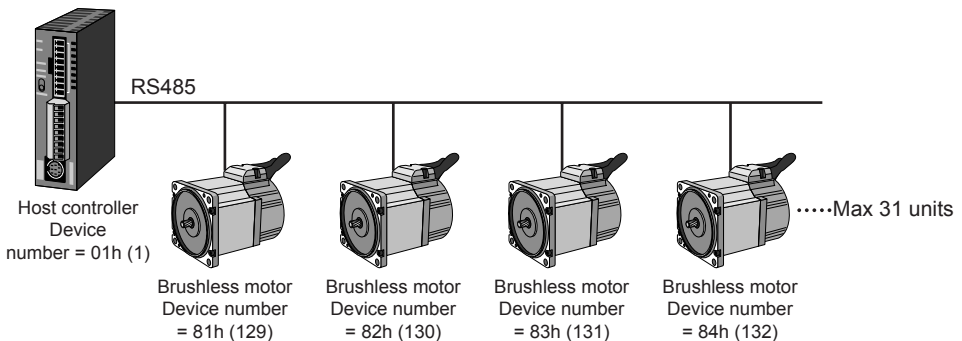

11. Appendix – Communication

Interface of communication Connector Unit

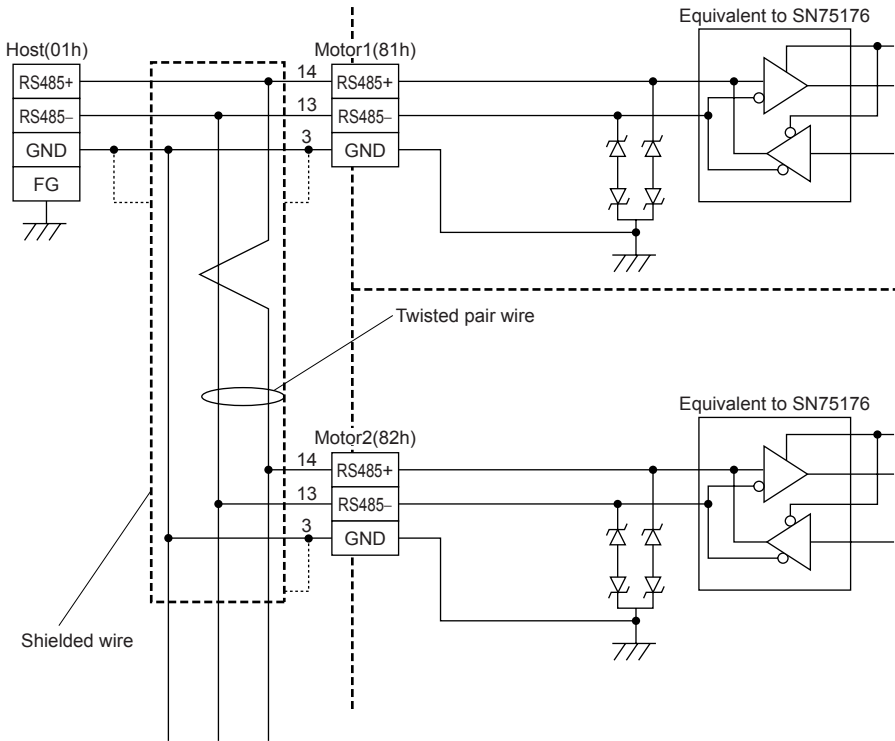

- Use the shield of shielded wire for GND.
- Set the maximum total extension of cable within 10m in use.
- Terminal resistor is not required.

Communication system

RS485	Half duplex, asynchronous communication method	
Communication baud rate	2400, 4800, 9600bps	Set by Pr61.
Data	7 bits, 8 bits	Set by Pr62.
Parity	None, even number, or odd number	Set by Pr62.
Start bit	1 bit	
Stop bit	1 bit, 2 bits	Set by Pr62.
Host address	01h - 1Fh	
Motor address	80h - 9Fh (80h for simultaneous transmission)	Set by Pr60.

- Modification of transmission parameters (Pr60 - 65) becomes effective when resetting the power supply of the motor.
- The transmission parameters can be changed by the digital keypad (sold separately) or RS485 communication.

List of data number related to communications

(1) Communication parameter

Data No. (address)	PrNo.	Parameter name	Range of setting	Default	Function/Description
8060h	60	Device number	80h(128) - 9Fh(159)	81h(129)	Set the device number of motor in communication (Motor ID). This value is the shaft number in communication. 80h (128) is the device number for setting control data (such as control start) by one operation to all connected motors. (No response is made by motors.) When the device number is set to 80h (128), change of parameter and request for status are ignored, therefore set to 81h (129) - 9Fh (159) normally.
8061h	61	Communication speed	0 - 2	2	Set the communication speed of RS485 communication. 0: 2400bps, 1: 4800bps, 2: 9600bps
8062h	62	Communication standard	0 - 11	4	Set the communication standard of RS485 communication. 0: 8 bits, no parity, stop bit 1 1: 8 bits, no parity, stop bit 2 2: 8 bits, odd number parity, stop bit 1 3: 8 bits, odd number parity, stop bit 2 4: 8 bits, even number parity, stop bit 1 5: 8 bits, even number parity, stop bit 2 6: 7 bits, no parity, stop bit 1 7: 7 bits, no parity, stop bit 2 8: 7 bits, odd number parity, stop bit 1 9: 7 bits, odd number parity, stop bit 2 10: 7 bits, even number parity, stop bit 1 11: 7 bits, even number parity, stop bit 2
8063h	63	Communication response time	10 - 1000	10	Communication response time is the shortest time for setting transmission mode in RS485 bus for response after the motor has received communication data. Actual data response time depends on the type and data of order. Unit [ms]
8064h	64	Retry times of communication	0 - 9	9	Set the retry times of RS485 communication. 0 - 8: Number of retrials, 9: No retrial
8065h	65	Protocol timeout	1 - 255	2	Protocol timeout is the time allowed from reception of a character code to reception of the next one in communication. If normal character code is not received within this time, communication is timed out, and received data is discarded. If timeout should continue to occur, and the number of detections exceed the retry times, the motor trips due to RS485 communication error. Unit [seconds]

Change of parameters above is made effective when power is turned on.

- Time required for data transmission per byte is calculated by the following formula for example in the case of 9600 [bps], 8 bits, parity present (even number or odd number), and stop bit 1:

$$(1000/9600) \times (1 + 8 + 1 + 1) = 1.14 \text{ [ms/byte]}$$
 Time is 4.58 [ms/byte] for 2400 [bps], and 2.29 [ms/byte] for 4800 [bps].
 Note, however, actual communication time will be added time necessary for processing received command, and necessary for switching between a line and transmission/reception control.

(2) Extension parameter (special command): 8103h - 81B0h

These are parameters to get motor status or to give commands to the motor. Refer to P.76 "Communication command" for detail.

11. Appendix – Communication

Transmission Sequence

● Handshake code

For line control, following codes are used:

Name	Code	Functions	Description
SOH	01h	Heading start	Start code of communication data, which is followed by address.
STX	02h	Text start	Start code for sending command data.
ETX	03h	Text end	Termination code for command data.
EOT	04h	Transmission end	Sent from the motor when transmission message is finished.
ENQ	05h	Request for sending	Inquiry code from host controller to motor. The motor sends data transmission command when sending data is available, and transmission end command when sending data is not available.
ACK	06h	Positive response	Sent when received message is judged to be normal.
NAK	15h	Negative response	Sent when received message is judged to be abnormal.

- Protocols are based on JISX5002.

● Composition of sent and received data

Shows composition of data transferred on physical phase.

There are two transmission patterns available depending on the contents of command.

Request for sending/ Positive response/
Negative response/ Transmission end command
(Host → Motor, Motor → Host)

Data transmission command
(Host → Motor, Motor → Host)

SOH
Sending address 1
Sending address 2
Senders address 1
Senders address 2
ENQ/ACK/NAK/EOT

SOH
Sending address 1
Sending address 2
Senders address 1
Senders address 2
STX
Command 1
Command 2
Data number 1
Data number 2
Data number 3
Data number 4
Data 1
Data 2
Data 3
Data 4
ETX
BCC

Note) Each box shown 1 byte data.

Sending address: Set the mating device number for sending data in ASCII2 byte.

Host ID 01h (01) - 1Fh (31)

Motor ID 80h (128) - 9Fh (159)

When the sending address is set to 80h (128), all connected motors executes the command (only for some commands). However, response is not made from the motor.

- Senders address** : Set the address of communication sending source (self) in ASCII 2 bytes.
 Host ID 01h (01) - 1Fh (31)
 Motor ID 81h (129) - 9Fh (159)
- Command** : Control command (2 bytes)
- Data number** : Set the data number to be controlled in ASCII 4 bytes.
- Data** : Set the writing data in ASCII 4 bytes.
 When data is minus, it is converted by signed 16 bits.
 (e.g. In the case of -10, data is ASCII code of hexadecimal FFF6.)
- BCC** : In the case of data transmission command, set XOR (logically inverted) value of each byte from STX - ETX.

● **List of commands**

Command	Code	Transmission direction	Description
\$P	24h 50h	Host → Motor	Data writing command. Change of parameter and motor control data. (In changing parameter, parameter is not written to EEPROM.)
\$S	24h 53h	Host → Motor	Data writing command. Change of parameter and motor control data. (In changing parameter, parameter is written to EEPROM.) *Writing to EEPROM should be requisite minimum. (EEPROM endurance: approx. 100,000 write cycle.)
\$R	24h 52h	Host → Motor	Data reading request command. Command which requests the parameter, status, and control detail of motor.
#R	23h 52h	Motor → Host	Response to data reading request. Returns the parameter, status, and control detail of motor to \$R.
#C	23h 43h	Motor → Host	Data update request response. Returns the status of motor (8103h) to host in response to request for sending command when data of motor status (8103h) has changed from previous request for sending.
#I	23h 49h	Motor → Host	Initial request response. When the motor is powered on, 9999 is sent following #I in response to initial inquiry from host controller (Request for sending).

● **Transmission procedure**

\$P/\$S: Data writing/Parameter writing command

① Host → Motor (Data writing)

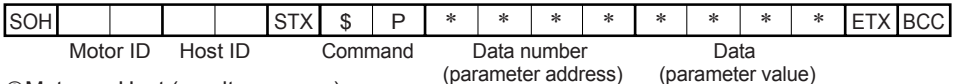

② Motor → Host (result response)



- Answers NAK when requested data number (parameter address) or data value (parameter value) is abnormal. Shows that parameter was properly set only when ACK is answered from the motor.
- No result is answered from the motor when motor ID is 80h (128).

11. Appendix – Communication

\$R: Data reading/Parameter reading command

① Host → Motor (Data reading request)

SOH					STX	\$	R	*	*	*	*	0	0	0	0	ETX	BCC	
	Motor ID		Host ID			Command		Data number (parameter address)	Data (parameter value)									

- Set data '0000' when executing data reading command.
- When motor ID is 80h (128), data reading/parameter reading command is ignored.

② Motor → Host (Result response)

SOH					ACK
	Host ID		Motor ID		

③ Host → Motor (Request for sending)

SOH					ENQ
	Motor ID		Host ID		

④ Motor → Host (Response of data)

SOH					STX	#	R	*	*	*	*	*	*	*	*	*	*	ETX	BCC
	Host ID		Motor ID			Command		Data number (parameter address)	Reading data (parameter value)										

- Response data when motor is powered on is initial request response.
- When requested data number (parameter address) is abnormal, '0000' as reading data (parameter address) is answered.
- Check whether the data No. (parameter address) is correct, then use the reading data.

⑤ Host → Motor (Result response)

SOH					ACK
	Motor ID		Host ID		

⑥ Motor → Host (Communication completion response)

SOH					EOT
	Host ID		Motor ID		

ENQ: Request for sending

When request for sending is sent to the motor, response data changes depending on the status of motor. Response data is returned in the priority order below:

1	When motor is powered on	Initial request response is answered.
2	When receiving data reading/parameter reading	See the data reading command processing.
3	When the status of motor changes	Data update request is answered.
4	Other cases than the above	Communication completion response is answered.

- Initial request response is answered to the initial data request for sending after the motor is powered on.
- When the motor ID is 80h (128), request for sending to the motor is ignored.

1. When the motor is powered on

① Host → Motor (Request for sending)

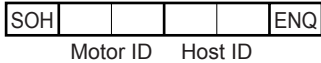

② Motor → Host (Response of data)

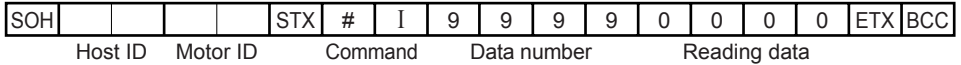

③ Host → Motor (Response of result)

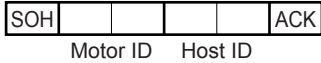

④ Motor → Host (Communication completion response)

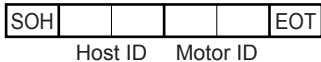

- When initial response is confirmed, write parameters as necessary.

2. When receiving data reading/parameter reading

See "\$R: Data reading/Parameter reading command" on page 70.

3. When the status of motor changes

① Host → Motor (Request for sending)

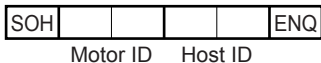

② Motor → Host (Response of data)

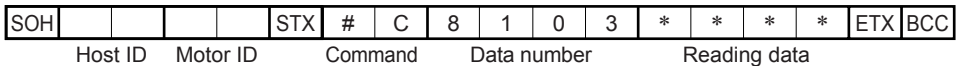

③ Host → Motor (Response of result)

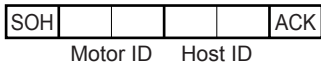

④ Motor → Host (Communication completion response)



- The motor saves the status when executing request for sending, and emits the above response when the status in receiving the next request for sending has changed. Read data is the same as in reading data number 8103h.
- When the motor is powered on, in the case where request for sending is sent continuously, data update request response is answered after initial request response is made.

4. Cases other than the above

① Host → Motor (Request for sending)

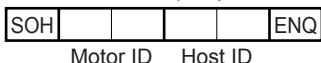

② Motor → Host (Communication completion response)

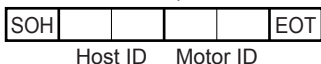

- The motor makes communication completion response because data is not requested from the host, and the status of motor has not changed.

11. Appendix – Communication

Example of Data Communication

● When power is turned on

Communication data is shown below in chronological order when request for sending is executed in power-on for the motor.

Initial request response at the first, and then data update request response is answered from the motor.

Then, if the status of motor has not changed, only transmission completion response is answered. Shown below is the status where the motor is connected with host ID = 01h (1), motor ID = 81h (129).

It is represented by ASCII characters. (Data in the parenthesis is hexadecimal ASCII code.)

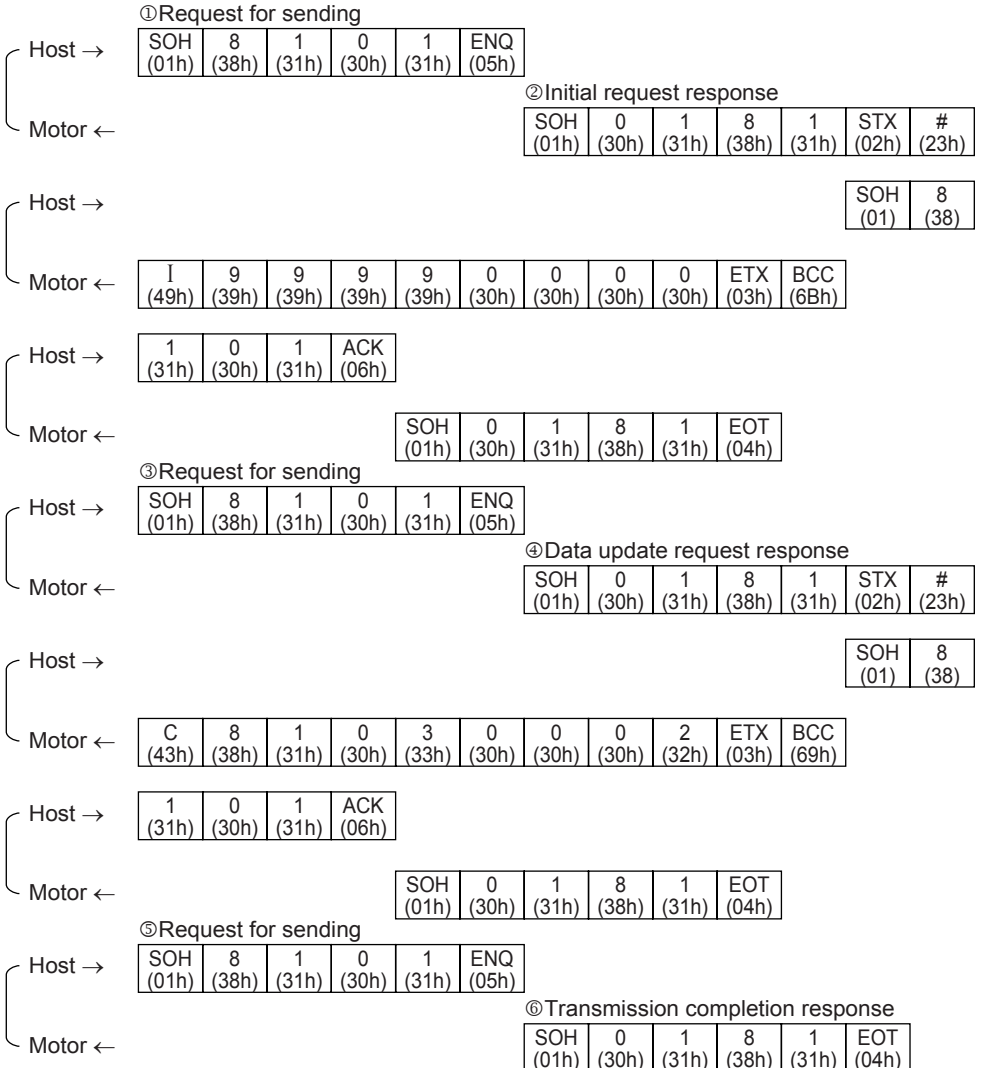

● **Example of trip reset**

Shown below is communication data in chronological order when executing trip reset. This is an example where trip reset of all motors connected by host ID = 01h (1). Data is represented by ASCII character. (Data in parenthesis is hexadecimal ASCII code.)

Host →	SOH	8	0	0	1	STX	\$	P	8	1	9	0	0
	(01h)	(38h)	(30h)	(30h)	(31h)	(02h)	(24h)	(50h)	(38h)	(31h)	(39h)	(30h)	(30h)
Motor ←													

Host →	0	0	1	ETX	BCC
	(30h)	(30h)	(31h)	(03h)	(74h)
Motor ←					

- There is no response from the motor because motor ID is set at 80h (128).

● **Example of changing parameter (writing data)**

Shown below is communication data in chronological order when changing parameter (not written to EEPROM).

This is an example of changing Pr00 (8000h) “The 1st target position (rotation number)” to 10 (0000Ah) with motor connected by host ID = 01h (1) and motor ID = 81h (129). Data is represented by ASCII character. (Data in parenthesis is hexadecimal ASCII code.)

Host →	SOH	8	1	0	1	STX	\$	P	8	0	0	0	0
	(01h)	(38h)	(31h)	(30h)	(31h)	(02h)	(24h)	(50h)	(38h)	(30h)	(30h)	(30h)	(30h)
Motor ←													

Host →	0	0	A	ETX	BCC
	(30h)	(30h)	(41h)	(03h)	(0Ch)

Motor ←	SOH	0	1	8	1	ACK
	(01h)	(30h)	(31h)	(38h)	(31h)	(06h)

11. Appendix – Communication

● Example of reading parameter (reading data)

In reading data, reading request is emitted to the motor, and then request for sending command is issued.

This is an example of reading Pr40 (8040h) “Homing mode” with the motor connected by host ID = 01h (1) and motor ID = 81h (129). (Data in parenthesis is hexadecimal ASCII code.)

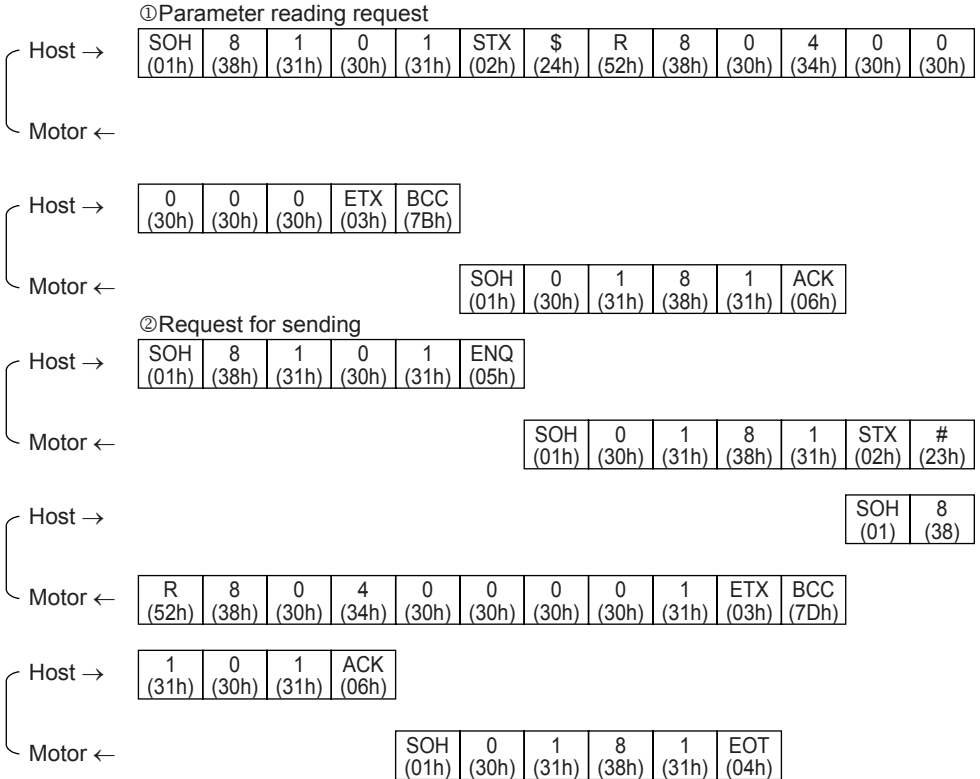

Communication Timing

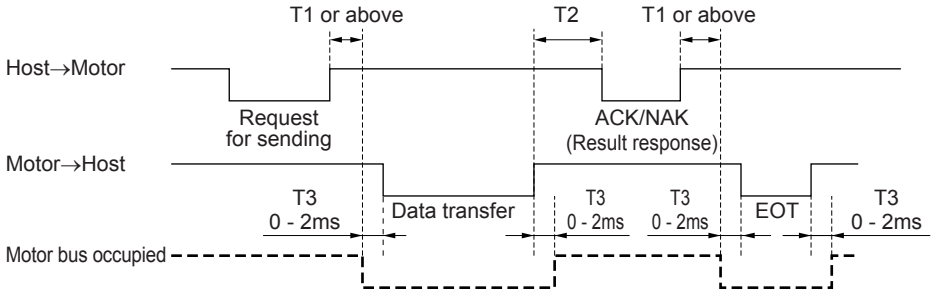

Symbol	Name	Value
T1	Communication response time (Motor)	Set by Pr63.
T2	Communication response time (Host)	Take interval 10ms or longer.
T3	Data emitting time from motor to host after bus is occupied	0 - 2ms

<Information>

- 1) Time is counted from the rising edge of stop bit.
- 2) Time allowed from receiving one character code until receiving the next character code can be set by Pr65 "Protocol timeout".
If the next normal character code cannot be received within the time set by this parameter, the motor detects communication timeout and received data is canceled. If communication timeout is detected continuously, and the number of detections exceeds the number of retrials (Pr64), the motor trips because of RS485 communication error.
- 3) When the host sends data and still does not receive any response from the motor, communication error may be present through effect of noise, etc. In this case, the host should send data again after time set by Pr65 "Protocol timeout".

<Communication establishing time when power is turned on>

Establishment communication takes about 800ms when the motor is powered on. The motor does not make response in the meantime, therefore allow waiting time longer than a second.

[Timing in power-on]

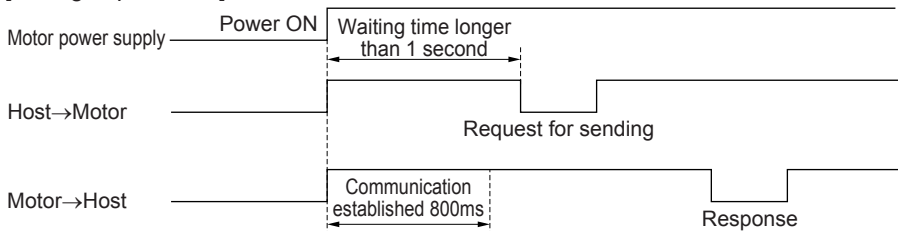

11. Appendix – Communication

Communication Command

Data number	Applicable command on host side	Description
8000h - 807Fh	\$P/\$S/\$R	Parameter
8103h	\$R	Motor status
8104h	\$R	Model code 1
8105h	\$R	Model code 2
8110h	\$R	Rotation speed (actual speed)
8111h	\$R	Commanded speed
8112h	\$R	Internal DC voltage
8113h	\$R	Torque
8114h	\$R	Load factor
8115h	\$R	Present position (rotation number)
8116h	\$R	Present position (pulse)
8117h	\$R	Target position (rotation number)
8118h	\$R	Target position (pulse)
8120h	\$R	Detail of trip
8130h	\$R	Input terminal status
8131h	\$R	Output terminal status
8180h	\$P/\$S	Run command
8190h	\$P/\$S	Trip reset
8191h	\$P/\$S	Forced trip
81B0h	\$P/\$S	Parameter EEPROM writing

Communication Command in Detail

8000h - 807Fh: Parameter

● \$P: Parameter writing command (Without EEPROM writing function)

Received data (Host → Motor)

SOH				STX	\$	P	8	0			P1	P2	P3	P4	ETX	BCC
	Motor ID	Host ID			Command		Parameter address				Parameter value					

- When the device number set on the motor (value of Pr60) matches with the motor ID of received data, parameter change is executed.
- When parameter address and parameter value are abnormal, NAK is answered.
- Set the parameter address at '80 □□'. ('8062' for Pr62)
- Set the parameter value in 4 digits of ASCII code (P1, P2, P3, and P4) which is obtained by conversion from the data to hexadecimal.
(e.g. 100 = '0064', -100 = 'FF9C')
- NAK is answered while the motor detects undervoltage error, and the parameter is not changed.
- Changed parameter is not written to EEPROM by this command. In order to make changed parameter still effective after power resetting, execute EEPROM writing command by data number 81B0h.
- When run command is executed by I/O while parameter is being written by communication at the same time, enter the run command after receiving ACK response from the motor. The motor runs per the written parameter.

● **\$\$: Parameter writing command (with EEPROM writing function)**

Received data (Host → Motor)

SOH				STX	\$	S	8	0			P1	P2	P3	P4	ETX	BCC
	Motor ID	Host ID			Command		Parameter address				Parameter value					

- When the device number set on the motor (value of Pr60) matches with the motor ID of received data, parameter change is executed.
- When parameter address and parameter value are abnormal, NAK is answered.
- Set the parameter address at '80 □□'. ('8062' for Pr62)
- Set the parameter value in 4 digits of ASCII code (P1, P2, P3, and P4) which is obtained by conversion from the data to hexadecimal.
(e.g. 100 = '0064', -100 = 'FF9C')
- NAK is answered while the motor detects undervoltage error, and the parameter is not changed.
- Changed parameter is written to EEPROM by this command. Response may take some time since EEPROM writing process is required.
- When run command is executed by I/O while parameter is being written by communication at the same time, enter the run command after receiving ACK response from the motor. The motor runs per the written parameter.
- Writing to EEPROM should be requisite minimum.

● **\$\$R: Parameter reading request command**

Received data (Host → Motor)

SOH				STX	\$	R	8	0			0	0	0	0	ETX	BCC
	Motor ID	Host ID			Command		Parameter address				Parameter value					

- Set the parameter address at '80 □□'. ('8062' for Pr62). Set the parameter value at '0000'.
- Enter request for sending after execution of this command, parameter value is responded.

● **#R: Parameter response command**

Transmission data (Motor → Host)

SOH				STX	#	R	8	0			P1	P2	P3	P4	ETX	BCC
	Host ID	Motor ID			Command		Parameter address				Parameter value					

- When requested parameter address is abnormal, '0000' as parameter value is answered. You should check parameter address as you requested.
- When the parameter reading request command is normally completed, the motor answers a parameter value when it receives request for sending.
- Parameter address which is read out is sent by '80 □□'.
- Parameter value is sent in 4 digits of ASCII code (P1, P2, P3, and P4) which is obtained by conversion from the data to hexadecimal.
e.g. 100 = '0064', -100 = 'FF9C'

11. Appendix – Communication

8103h: Motor status

● \$R: Status reading request command

Received data (Host → Motor)

SOH				STX	\$	R	8	1	0	3	0	0	0	0	ETX	BCC
	Motor ID	Host ID			Command		Data number			Data value						

- Enter request for sending after execution of this command, the motor status is answered.
- Set '0000' in data value.

● #R: Status response command

Transmission data (Motor → Host)

SOH				STX	#	R	8	1	0	3	D1	D2	D3	D4	ETX	BCC
	Host ID	Motor ID			Command		Data number			Data value						

- When the motor receives request for sending after normal completion of status reading request command, the motor answers status value.

● #C: Data updating request command

Transmission data (Motor → Host)

SOH				STX	#	C	8	1	0	3	D1	D2	D3	D4	ETX	BCC
	Host ID	Motor ID			Command		Data number			Data value						

- The motor saves the status in executing request for sending, and makes the response above when the status in receiving the next request for sending has changed. Read data is the same as in execution of data number 8103.

[Detail of status]

	Bit 3	Bit 2	Bit 1	Bit 0
D1	0	0	0	0
D2	0	0	0	0
D3	Torque under restriction	Overload detection	0	0
D4	Homing completion	In-motion	In-position	Trip output

Detail above is converted into hexadecimal and represented in ASCII code.

e.g.) Data value = 30h 30h 30h 41h = '000A' = indicates in-position status with homing completed.

8104h: Model code 1, 8105h: Model code 2

● \$R: Model code reading request command

Received data (Host → Motor)

SOH				STX	\$	R	8	1	0		0	0	0	0	ETX	BCC
	Motor ID	Host ID			Command		Data number				Data value					

- Enter request for sending after execution of this command, model code of motor is answered.
- Set '0000' in data value.

● #R: Model code response command

Transmission data (Motor → Host)

SOH				STX	#	R	8	1	0		D1	D2	D3	D4	ETX	BCC
	Host ID	Motor ID			Command		Data number				Data value					

- When the motor receives request for sending after completion of model code reading request command, the model code value is answered.
- Model name of the motor is sent in ASCII code of total 8 characters, consisting of 4 characters respectively.

e.g.) Model code 1 ('8104') = 4Dh42h4Dh50h = 'MBMP'

Model code 2 ('8105') = 33h41h31h45h = '3A1E'

8110h: Rotation speed (actual speed), 8111h: Commanded speed

● \$R: Speed reading request command

Received data (Host → Motor)

SOH				STX	\$	R	8	1	1		0	0	0	0	ETX	BCC
	Motor ID	Host ID			Command		Data number				Data value					

- Rotation speed of motor (actual speed) ('8110') and commanded speed ('8111') are answered by request for sending after execution of this command.
- Set '0000' in data value.

● #R: Speed response command

Transmission data (Motor → Host)

SOH				STX	#	R	8	1	1		D1	D2	D3	D4	ETX	BCC
	Host ID	Motor ID			Command		Data number				Data value					

- When the motor receives request for sending after normal completion of speed reading request command, rotation speed value (actual speed value) ('8110') and commanded speed value ('8111') are answered.
- Data value is answered in rotation speed (actual speed) and commanded speed in [r/min].
e.g.) Data value = 30h 42h 42h 38h = '0BBB' = 3000 [r/min]
Data value = 30h 35h 44h 43h = '05DC' = 1500 [r/min]
The value shall be positive at CCW rotation and negative at CW rotation.

11. Appendix — Communication

8112h: Internal DC voltage

● \$R: Internal DC voltage reading request command

Received data (Host → Motor)

SOH				STX	\$	R	8	1	1	2	0	0	0	0	ETX	BCC
	Motor ID	Host ID			Command		Data number			Data value						

- Enter request for sending after execution of this command, the internal DC voltage (voltage in smoothing capacitor of power supply) of the motor is answered.
- Set '0000' in data value.

● #R: Internal DC voltage response command

Transmission data (Motor → Host)

SOH				STX	#	R	8	1	1	2	D1	D2	D3	D4	ETX	BCC
	Host ID	Motor ID			Command		Data number			Data value						

- When the motor receives request for sending after normal completion of internal DC voltage reading command, internal DC voltage (voltage in smoothing capacitor of power supply) is answered.
- Voltage of motor is answered in [V] for data value.
e.g.) Data value = 30h 31h 31h 38h = '0118' = 280[V]

8113h: Torque 8114h: Load factor

● \$R: Torque reading request command

Received data (Host → Motor)

SOH				STX	\$	R	8	1	1		0	0	0	0	ETX	BCC
	Motor ID	Host ID			Command		Data number			Data value						

- Enter request for sending after execution of this command, torque of motor ('8113') and load factor ('8114') are answered.
- Set '0000' in data value.

● #R: Torque response command

Transmission data (Motor → Host)

SOH				STX	#	R	8	1	1		D1	D2	D3	D4	ETX	BCC
	Host ID	Motor ID			Command		Data number			Data value						

- When the motor receives request for sending after normal completion of torque reading request command, torque ('8113') and load factor ('8114') are answered.
- Torque of motor/Load factor multiplied by 10 is answered in [%] for data value.
e.g.) Data value = 30h 31h 32h 43h = '012C' = 30.0[%]

8115h: Present position (rotation number), 8116h: Present position (pulse)

● \$R: Present position reading request command

Received data (Host → Motor)

SOH				STX	\$	R	8	1	1		0	0	0	0	ETX	BCC
	Motor ID	Host ID			Command		Data number				Data value					

- Enter request for sending after execution of this command, present position (rotation number) ('8115') and present position (pulse) ('8116') of the motor are answered.
- Set '0000' in data value.
- **This command updates the data of 8116h (pulse) when the present position information 8115h (rotation number) reading command is received.**
Therefore, if data of 8116h (pulse) should be read first, it is possible that wrong present position information before updating may be read out; so be sure to follow the reading order: 8115h (rotation number) → 8116h (pulse). Use for only monitoring function.

● #R: Present position response command

Transmission data (Motor → Host)

SOH				STX	#	R	8	1	1		D1	D2	D3	D4	ETX	BCC
	Host ID	Motor ID			Command		Data number				Data value					

- When the motor receives request for sending after normal completion of present position reading request command, present position (rotation number) ('8115') and present position (pulse) ('8116') of the motor are answered.
- Present position of the motor in command pulse unit (288 pulses per rotation) is described by $\text{rotation number} \times 288 + \text{pulse}$.

8117h: Target position (rotation number), 8118h: Target position (pulse)

● \$R: Target position reading request command

Received data (Host → Motor)

SOH				STX	\$	R	8	1	1		0	0	0	0	ETX	BCC
	Motor ID	Host ID			Command		Data number				Data value					

- Enter request for sending after execution of this command, travel target position (rotation number) ('8117') and target position (pulse) ('8118') in the absolute coordinates of motor in positioning operation are answered.
- Set '0000' in data value.
- **This command updates data of 8118h (pulse) when reading 8117h (rotation number) of target position information.**
Therefore, if data of 8118h (pulse) should be read first, it is possible that wrong target position information before updating may be read out; so be sure to follow the reading order: 8117h (rotation number) → 8118h (pulse). Use for only monitoring function.

11. Appendix – Communication

● #R: Target position response command

Transmission data (Motor → Host)

SOH					STX	#	R	8	1	1			D1	D2	D3	D4	ETX	BCC	
	Host ID		Motor ID		Command			Data number											

- When the motor receives request for sending after normal completion of target position reading request command, travel target position (rotation number) ('8117') and target position (pulse) ('8118') of the motor are answered.
- Target position of the motor in command pulse unit (288 pulses per rotation) is described by rotation number × 288 + pulse.
- Target position in power-on is '0'. Target position when the motor trips is updated to the present position. When the motor is stopped halfway by stop command, the target position is updated to the stop position.

8120h: Detail of trip

● \$R: Trip detail reading request command

Received data (Host → Motor)

SOH					STX	\$	R	8	1	2	0	0	0	0	0	0	0	ETX	BCC
	Motor ID		Host ID		Command			Data number											

- Enter request for sending after execution of this command, the detail of trip is answered.
- Set '0000' in data value.

● #R: Trip detail response command

Transmission data (Motor → Host)

SOH					STX	#	R	8	1	1			D1	D2	D3	D4	ETX	BCC	
	Host ID		Motor ID		Command			Data number											

- When the motor receives request for sending after normal completion of trip detail reading request command, detail of motor trip is answered.
- Detail of trip is answered by trip number. (See the list of protective functions on page 46.)
When the trip number is 0, it indicates that no tripping has occurred.
e.g.) Data value = 30h 30h 31h 35h = '0015' = 21 = homing error
- Trip history can be read out with parameter (Pr 6b - 6F).

8130h: Input terminal status

● \$R: Input terminal status reading request command

Received data (Host → Motor)

SOH					STX	\$	R	8	1	3	0	0	0	0	0	0	0	ETX	BCC
	Motor ID		Host ID		Command			Data number											

- Enter request for sending after execution of this command, the status of motor input terminal is answered.
- Set '0000' in data value.

● **#R: Input terminal status response command**

Transmission data (Motor → Host)

SOH				STX	#	R	8	1	3	0	D1	D2	D3	D4	ETX	BCC
	Host ID	Motor ID		Command			Data number				Data value					

- When the motor receives request for sending after normal completion of input terminal status reading request command, the input terminal status of the motor is answered.

[Status of input terminal]

	Bit 3	Bit 2	Bit 1	Bit 0
D1	0	0	0	0
D2	0	0	0	0
D3	0	0	0	0
D4	I4	I3	I2	I1

Detail above is converted into hexadecimal and represented in ASCII code.

e.g.) Data value = 30h 30h 30h 35h = '0005' = Indicates that I1 and I3 are on.

8131h: Output terminal status

● **\$R: Output terminal status reading request command**

Received data (Host → Motor)

SOH				STX	\$	R	8	1	3	1	0	0	0	0	ETX	BCC
	Motor ID	Host ID		Command			Data number				Data value					

- Enter request for sending after execution of this command, the status of motor output terminal is answered.
- Set '0000' in data value.

● **#R: Output terminal status response command**

Transmission data (Motor → Host)

SOH				STX	#	R	8	1	3	1	D1	D2	D3	D4	ETX	BCC
	Host ID	Motor ID		Command			Data number				Data value					

- When the motor receives request for sending after normal completion of output terminal status reading request command, the output terminal status of the motor is answered.

[Status of output terminal]

	Bit 3	Bit 2	Bit 1	Bit 0
D1	0	0	0	0
D2	0	0	0	0
D3	0	0	0	0
D4	0	0	O2	O1

Detail above is converted into hexadecimal and represented in ASCII code.

e.g.) Data value = 30h 30h 30h 31h = '0001' = Indicates that O1 is on.

11. Appendix— Communication

8180h: Run command

● \$P/\$S: Run command

Received data (Host → Motor)

SOH				STX	\$	P	8	1	8	0	D1	D2	D3	D4	ETX	BCC
	Motor ID	Host ID			Command			Data number			Data value					

- When the motor is powered on with Pr3E set at “1” (Command through RS485), this command enables sending run command to the motor. At this time, point selection or run command cannot be given through I/O. (See I1 function selection on page 42.)
When Pr3E is “0” (command through I/O), run command by this command is ignored.
- When run command is given to the motor with this command, first send ‘0000’ as a data value.
- Operation is the same both for \$P command and \$S command.
- When the motor ID is 80h (128), all connected motors execute the command.
However, no response is emitted from the motor.

[Run command]

	Bit 3	Bit 2	Bit 1	Bit 0
D1	REV	0	0	0
D2	0	M_FREE	S_STOP	H_STOP
D3	POINT2	POINT1	0	HOMING
D4	JOG_REV	JOG_FWD	POINT	STEP

Name	Function	Detail
H_STOP*	Instantaneous stop	When the motor is in motion, stop the motor based on setting of Pr59 "Deceleration time in instantaneous stop". Operation directive is not accepted as long as this signal is on.
S_STOP*	Deceleration stop	The motor reduces speed and stops when it is in motion. Operation directive is not accepted when the motor is stopped or when this signal is on.
M_FREE*	Motor-free	Sets the motor free. Operation directive is not accepted as long as this signal is on.
STEP	Sequential run start	Whenever this signal is turned on, positioning point number is automatically incremented by 1 to executed positioning. Maximum point number of positioning is determined by Pr0E.
POINT	Run start	Executes positioning operation to the point chosen by POINT 1 and 2.
JOG_FWD	Forward jog start	The motor operates in + direction as long as this signal is on.
JOG_REV	Reverse jog start	The motor operates in – direction as long as this signal is on.
HOMING	Homing start	Homing operation is started when this signal is turned on.
POINT1	Point designation 1	Choose a point number.
POINT2	Point designation 2	Choose a point number.
REV	Direction switching	Motor operation signal is inverted when this signal is on.

* When a signal of the same function is assigned to the input signal (I1 - I4), function is made effective by activation of any signal.

Detail above is converted into hexadecimal and represented in ASCII code.

e.g.) Data value = 30h 30h 31h 30h = '0010' = Indicates homing start.

8190h: Trip reset

● \$P/\$S: Trip reset command

Received data (Host → Motor)

SOH				STX	\$	P	8	1	9	0	0	0	0	1	ETX	BCC
	Motor ID		Host ID		Command		Data number			Data value						

- When data value is set at '0001' and this command is executed during trip, trip reset is executed.
- When data value is other than '0000' and '0001', NAK is answered.
- Operation is the same for both \$P command and \$S command.
- This command is incapable of resetting some trips depending on their factor.
As for tripped condition after executing trip reset command, check it by status reading or trip detail reading command.
- When motor ID is set to 80h (128), all connected motors execute the command.
However, no response is answered from the motor.

8191h: Forced trip

● \$P/\$S: Forced trip command

Received data (Host → Motor)

SOH				STX	\$	P	8	1	9	1	0	0	0	1	ETX	BCC
	Motor ID		Host ID		Command		Data number			Data value						

- When data value is set to '0001' and this command executed, the motor trips (forced trip).
- When data value is other than '0000' and '0001', NAK is answered.
- Operation is the same for both \$P command and \$S command.
- When motor ID is set to 80h (128), all connected motors execute the command.
However, no response is answered from the motor.

81B0h: Parameter EEPROM writing

● \$P/\$S: Parameter EEPROM writing command

Received data (Host → Motor)

SOH				STX	\$	P	8	1	B	0	0	0	0	1	ETX	BCC
	Motor ID		Host ID		Command		Data number			Data value						

- When data value is set to '0001' and this command executed, parameter is written to EEPROM contained in the motor. Response may take some time because EEPROM writing process is executed.
Use this command when you want to change the parameter by \$P command and make change still effective after power resetting.
- NAK is answered and EEPROM writing process is not executed as long as the motor detects undervoltage error.
- When data value is other than '0000' and '0001', NAK is answered.
- Operation is the same for both \$P command and \$S command.
- When motor ID is set to 80h (128), all connected motors execute the command.
However, no response is answered from the motor.
- Writing to EEPROM should be requisite minimum.

12. Specifications

General specification

Basic specification	Allowed range of supply voltage fluctuation	±10%
	Power supply frequency	50/60Hz
	Control method	Position control by CS signal, PWM sine wave driving system, 8kHz
	Bearing	Ball bearing
	Ambient conditions	See "2. Installation" on page 8.
Function	Number of positioning points	4 points (Travel distance, speed, acceleration time, deceleration time, and relative/absolute can be set per point.)
	Positioning resolution	288 pulses/rotation (Accuracy: Within – 5 degrees at 20°C at no load)
	Input signal	4 inputs
	Output signal	2 outputs (Open collector)
	Protective function	Overload, Overcurrent, Overvoltage, Undervoltage, System error, Setting change warning, Over-speed, Sensor error, Overheat, Position error, External forced trip, Position error counter overflow, RS485 communication error, Operation execution error, Homing error, present position overflow, Hardware limit error, Digital keypad communication trouble, user parameter error, and system parameter error
	Communication function via RS232C	Setting of parameter and monitoring of control condition are enabled with commercial PC. (Connection cable (sold separately) is required when commercial PC is connected.)
	Communication function via RS485	Setting of parameter, monitoring of control condition, and the like are enabled with RS485 interface.
	Digital keypad (sold separately)	Available
Performance	Overload rating	150%, 1 minute
	Starting torque	150%
Cooling system		Self cooling
Heat resistance class		E (Applies for A to UL.)
Protective structure		See "2. Installation" on page 8.

Typical characteristics

Model name	Rated output [W]	Input voltage [V]	Number of polarities [P]	Time rating	Rated rotation speed [r/min]	Rated torque [N.m]	Starting torque *1 [N.m]	Rated input current [Arms]	Rotor inertia [x10 ⁻⁴ kg·m ²]	Mass [kg]
MBMP3A1EBC MBMP3A1ESC	30	100 - 120	8	100% continuous	3000	0.095	0.14	1.0	0.65	1.1
MBMP3A2EBC MBMP3A2ESC		200 - 240						0.6		
MBMP5A1EBC MBMP5A1ESC	50	100 - 120	8	100% continuous	3000	0.16	0.24	1.5	0.87	1.3
MBMP5A2EBC MBMP5A2ESC		200 - 240						0.7		
MBMP9A1EBC MBMP9A1ESC	90	100 - 120	8	100% continuous	3000	0.29	0.43	2.0	1.54	2.3
MBMP9A2EBC MBMP9A2ESC		200 - 240						1.1		
MBMP1E2EBC MBMP1E2ESC	130	200 - 240	8	100%: 30 minutes 80%: continuous	3000	0.41	0.62	1.5	1.54	2.3

*1: Starting torque is a typical value.

● Speed – Torque characteristics

MBMP3A1EBC/MBMP3A1ESC
MBMP3A2EBC/MBMP3A2ESC

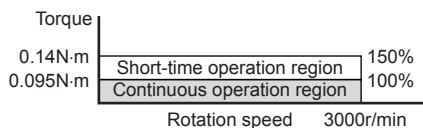

MBMP5A1EBC/MBMP5A1ESC
MBMP5A2EBC/MBMP5A2ESC

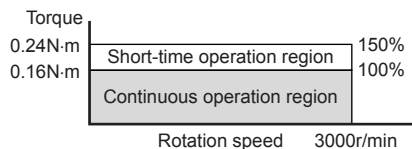

MBMP9A1EBC/MBMP9A1ESC
MBMP9A2EBC/MBMP9A2ESC

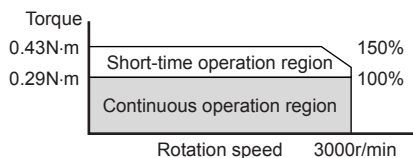

MBMP1E2EBC/MBMP1E2ESC

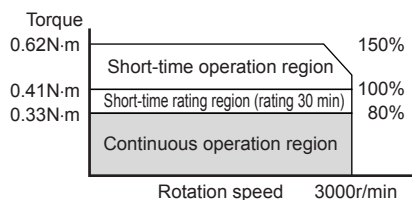

12. Specifications

Dimensional Outline Drawing (in mm)

● Motor

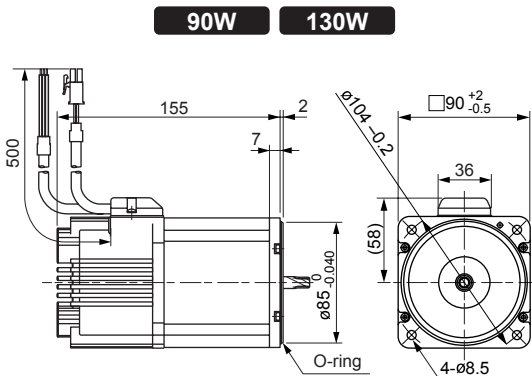
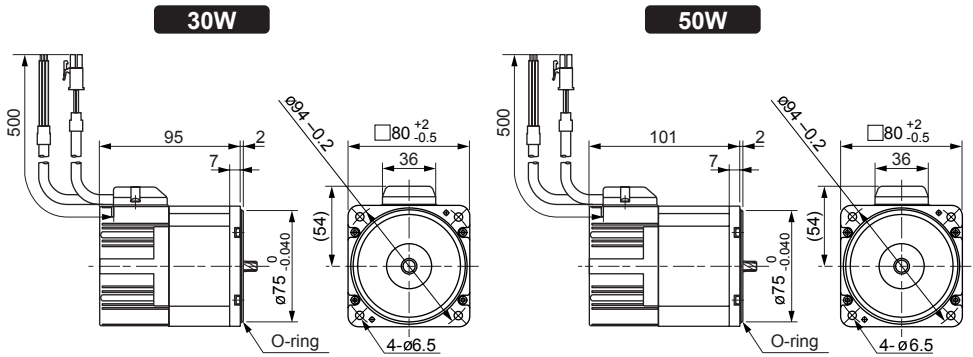

Round shaft type

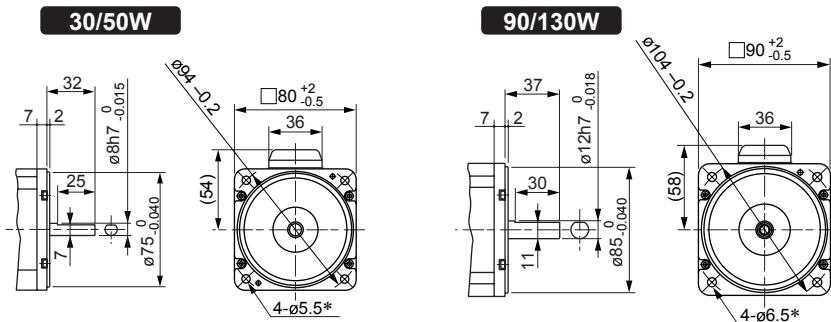

*Mounting hole diameter of motor is different from that for MB type gear head. Use caution.

● Gear head

MB8G□BV (For 30W/50W motor, sold separately)

- Reduction gear ratio in □
- Reduction gear ratio is available in 6 types: 5, 10, 15, 20, 30, and 50.

Key dimension

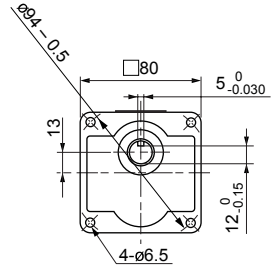
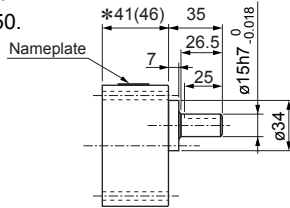

<Information>

Dimension in () marked with * indicates dimension with reduction gear ratio 30 or above.

[Attachments of MB8G]

Parts name	Dimension	Application	Quantity	Remarks
Gear head mounting screw	M6 × length 65	MB8G5BV - MB8G20BV	4	Hexagon socket head bolt
	M6 × length 70	MB8G30BV, MB8G50BV	4	Hexagon socket head bolt
Nut	M6		4	
Flat washer	For M6		4	
Temporary assembling screw	M2.6 × length 12		2	Hexagon socket head bolt
Key	(See key dimension.)		1	

MB9G□BV (For 90W/130W motor, sold separately)

- Reduction gear ratio in □
- Reduction gear ratio is available in 6 types: 5, 10, 15, 20, 30, and 50.

Key dimension

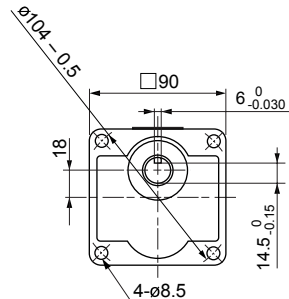
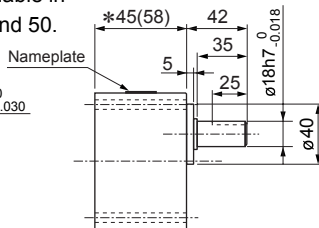
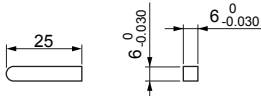

<Information>

Dimension in () marked with * indicates dimension with reduction gear ratio 30 or above.

[Attachments of MB9G]

Parts name	Dimension	Application	Quantity	Remarks
Gear head mounting screw	M8 × length 75	MB9G5BV - MB9G20BV	4	Hexagon socket head bolt
	M8 × length 90	MB9G30BV, MB9G50BV	4	Hexagon socket head bolt
Nut	M8		4	
Flat washer	For M8		4	
Temporary assembling screw	M3 × length 12		2	Hexagon socket head bolt
Key	(See key dimension.)		1	

13. Options (sold separately)

● Digital keypad (sold separately)

Part number: DV0P3510

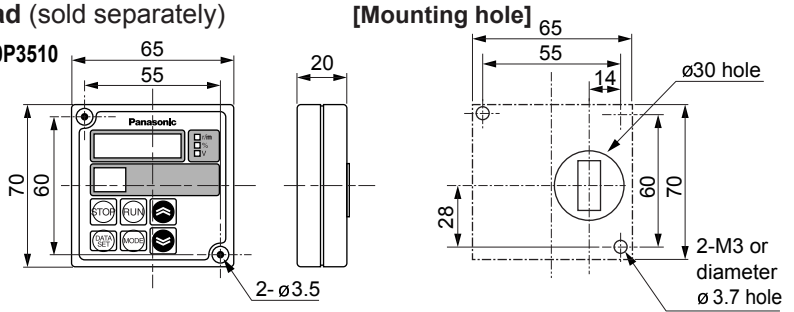

● Control signal extension cable (14-pin) (sold separately)

Part number	Length (L)
DV0P38510	1m
DV0P38530	3m
DV0P38550	5m

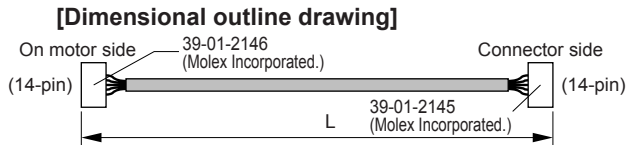

● Control signal conversion cable (14-pin – 10-pin) (sold separately)

Part number	Length (L)
DV0P38605	0.5m

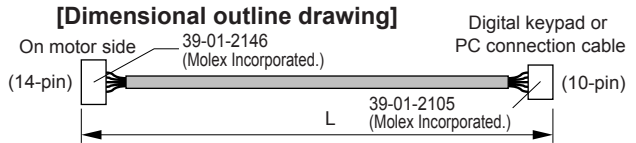

● Control signal branch cable (14-pin – 14, 10-pin) (sold separately)

Part number	Length (L)
DV0P38805	0.5m

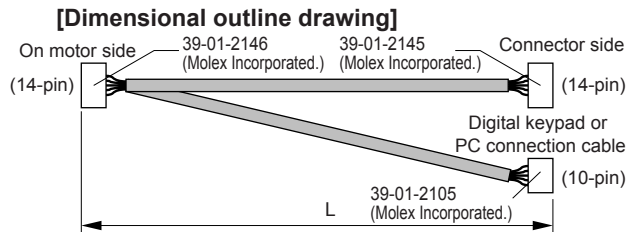

● Connector kit (sold separately)

Part number		Description
DV0P3890	Engaged on motor side	39-01-2146(5559-14P 210) × 1 piece, Pin 39-00-0049 (5558T2L) × 14 pieces (Molex Incorporated)
DV0P3900	Connector side	39-01-2145(5557-14R 210) × 1 piece, Pin 39-00-0047 (5556T2L) × 14 pieces (Molex Incorporated)
DV0P3610	Engaged on the digital keypad	39-01-2105(5557-10R 210) × 1 piece, Pin 39-00-0047 (5556T2L) × 10 pieces (Molex Incorporated)

· Applicable wire size: AWG22 ~ 26

· Applicable manual press-fit tool: 57064-5000 or 57038-5300 (Molex Incorporated)

● Communication software "PANATERM® for BL" (sold separately): DV0P4270

● PC cable (10-pin, 14-pin- D sub connector pin, 1.5m) (sold separately): DV0P4140

Limited warranty

Warranty period

- Warranty period of this product is 1 year from purchasing, or 1.5 years from our manufacturing month.
However, respective life shall not be exceeded as for standard life describing items.
(See “Installation/Checking the load and use condition” on page 12.)

Detail of warranty

- If any trouble should be found within warranty period under normal use condition in conformance with this instruction manual, it will be repaired free of charge.
Repair will be chargeable in the following cases even if within warranty period:
 - ① When trouble is caused by wrong use, and inappropriate repair or modification.
 - ② When trouble is caused by dropping after purchase, or damage in transportation.
 - ③ When trouble is caused by use out of specification range of the product.
 - ④ When trouble is caused by fire, earthquake, lightning stroke, damage by wind and flood, damage by salt, abnormal voltage and any other natural disaster.
 - ⑤ When trouble is caused by entry of water, oil, metal strip, and any other foreign substance.
- Warranty covers only the body of delivered product, and damage induced by trouble of delivered products will be excluded from compensation.

Caution in use

- If you are planning to use this product under special environment, such as atomic power control, aerospace equipment, traffic organization, medical equipment, various safety systems, and equipment which requires cleanliness, please contact us.
- When this product is operated without the shaft electrically grounded, such as in driving the fan, bearing noise may become higher due to the occurrence of electrocorrosion depending on the motor used or setting environment, so confirm and verify the condition on the customer side in such a case.
- Although we make as much efforts as possible for assuring the quality of this product, it is possible that the product operates out of setting due to external noise more than expected, application of static electricity, or unlikely malfunction of input power supply, wiring, and components; therefore we would ask you customers to apply failsafe design and ensure safety in the operable range in operating area.

After-sale service (repair)

Repair

- Ask the sales agent where the product was purchased for details of repair work.
When the product is installed in a machine or device, consult first the manufacturer of the machine or device.

Web site

- Web site of Motor Company, Matsushita Electric Industrial Co., Ltd.
<http://panasonic.co.jp/motor/eng/>

Memorandum (Fill in the blanks for convenience in case of inquiry or repair)

Date of purchase	Date:	Model No.	MBMP	<input type="checkbox"/>	<input type="checkbox"/>	<input type="checkbox"/>	E	<input type="checkbox"/>	<input type="checkbox"/>
Place of purchase									
	Telephone No.								

Motor Company, Matsushita Electric Industrial Co., Ltd.

7-1-1, Morofuku, Daito, Osaka 574-0044, Japan