

**RoHS** RoHS-Compliant

## 5-Phase Stepping Motor and Driver Package

# CRK Series

● Additional Information ●  
 Technical reference → Page F-1  
 Safety standards → Page G-2

The **CRK** Series is a motor and driver package combining a high-performance, 5-phase stepping motor with a compact, low-vibration microstep driver offering the Smooth Drive Function. Four frame sizes of 20 mm, 28 mm, 42 mm and 60 mm are available, as well as various geared motor units.

## Features

### ● Newly Designed Motors

#### ◇ High-Resolution Motor

##### ● Improved Stopping Accuracy

The positioning accuracy of a stepping motor is affected by friction load.

The high-resolution type achieve high accuracy and reliability based on Oriental Motor's latest precision machining technology. The motor resolution is increased to double the level of a standard model to reduce the displacement angle against load torque, thereby achieve high positioning accuracy. Vibration is also reduced.

Standard type: 50 teeth

Resolution: **500** per revolution = 0.72°/step

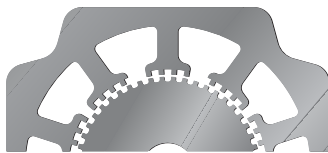

Resolution is increased!

High-resolution type: 100 teeth

Resolution: **1000** per revolution = 0.36°/step

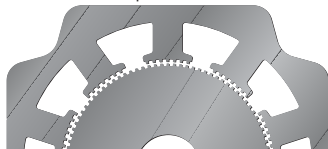

### Comparison of Angle – Torque Characteristics

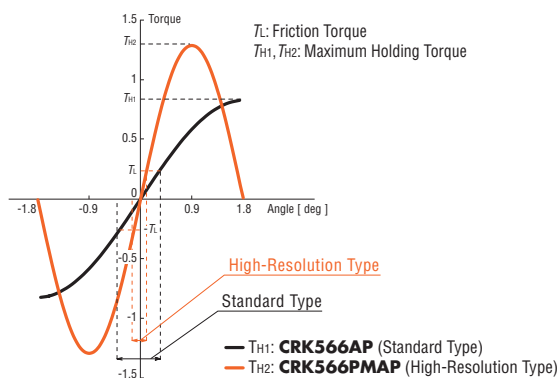

● List of safety standard approved products (Model, Standards, File No., Certification Body)  
 → Page G-10

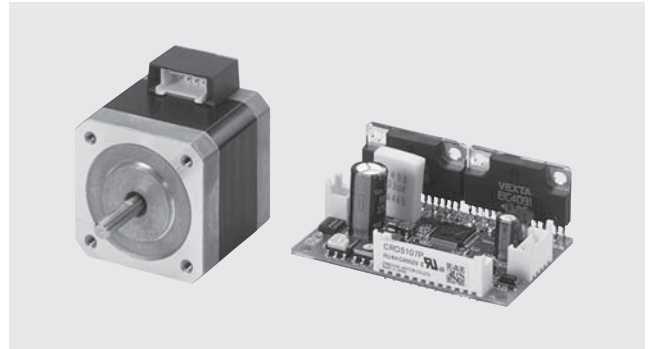

### ● Stop Position Accuracy

The high-resolution type is designed with a stop position accuracy of 2 arc minutes (0.034°) [standard type: 3 arc minutes (0.05°)]. The reduced error helps improve the positioning accuracy of your equipment.

### Static Angle Characteristics

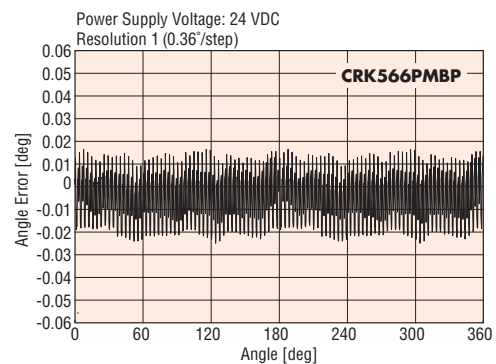

### ◇ High-Torque Motor

The high-resolution type and high-torque type adopt a newly designed high-torque motor that widens the range of applications.

- The smaller motor allows for compact equipment design.
- The motor current is reduced to suppress heat generation.

Example: Avoidance of temperature rise in precision equipment or machinery

### Comparison of Speed – Torque Characteristics

Current: 1.4 A/Phase Step Angle: 0.36°/step  
 With Damper **D6CL-8.0F**:  $J_L=140 \times 10^{-7} \text{kg} \cdot \text{m}^2$

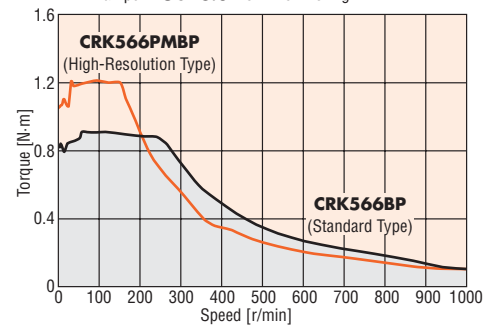

### ◇ Adopting a Connector Coupling Method

The high-resolution type and high-torque type are connected using a connector — a connection method everyone is familiar with.

- Desired cable length and type can be selected.
- Maintenance becomes easy.
- Motor lead wire/connector assembly (0.6m) is included with motor and driver package.

### ● Wide Range of Motor Variations

The **CRK** Series offers models of the high-resolution type, high-torque type and standard type, as well as various geared types. You can find a product meeting your specific torque, resolution or other needs from a wide range of specifications.

### ● Compact, Lightweight Microstep Driver

The driver in the **CRK** Series achieves microstep drive in a compact, lightweight body (Mass: 40 g). A new IC allows the driver to provide various functions, including the following:

- Smooth Drive Function
- 1-pulse/2-pulse input mode switching
- 25 preset step angles
- Power LED
- Photocoupler input
- Connector with lock (by MOLEX)

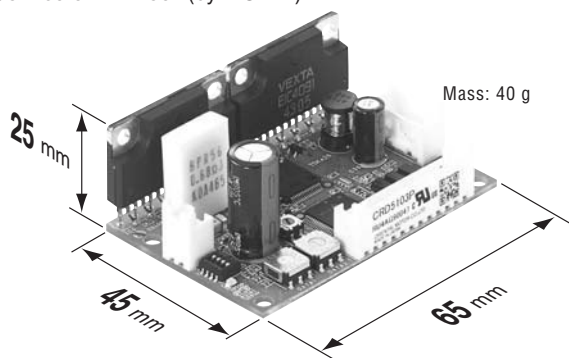

### ◇ Lower Vibration and Noise Achieved by Microstep Drive

The basic step angle of the motor can be divided into a maximum of 250 microstep angles without using any mechanical element such as a reduction gear.

As a result, vibration and noise are further reduced.

### ◇ Smooth Drive Function for Enhanced Ease of Use

The Smooth Drive Function automatically controls operations via microstep drive, at the same travel distance and speed used in the full-step mode, without requiring the operator to change the pulse input settings.

This function is particularly useful when the **CRK** Series is used in the full-step or half-step mode.

#### Comparison of Vibration Characteristics

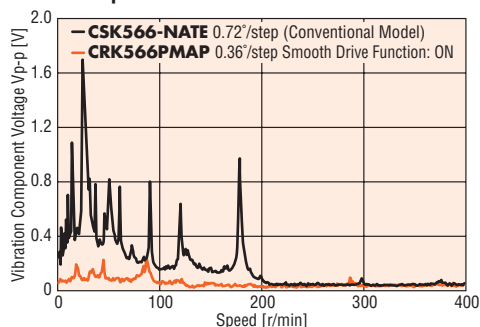

### ◇ Compact Size

The compact, lightweight driver in the **CRK** Series is approximately 47% smaller than a conventional full-step driver.

#### Comparison of Driver Size and Mass

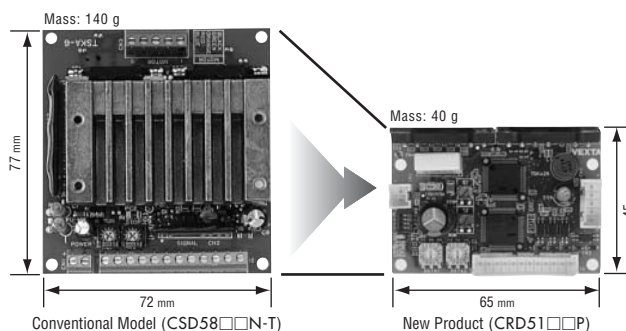

### ● Conforming to Major Safety Standards



The **CRK** Series is UL-recognized and CSA-certified. It also bears the CE Mark as a proof of conformance to the EMC Directives.

Safe operation is ensured anywhere in the world.

### ● RoHS RoHS-Compliant

The **CRK** Series conforms to the RoHS Directive that prohibits the use of six chemical substances including lead and cadmium.

● Details of RoHS Directive → Page G-23

### ● Useful Accessories

#### ● Driver Lead Wire Set

















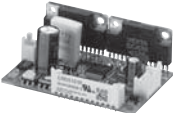

These lead wires allow for easy connection of the motor, power supply and input signals without crimping. All driver lead wires needed to connect the motor, power supply and I/O signals are combined in a single set. Various other parts and accessories useful in different applications are also available (sold separately).

Driver lead wire set → Page C-257

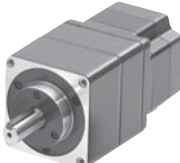

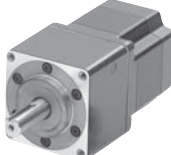



## Wide Variety

The **CRK** Series motor and driver package comes in four motor frame sizes of 20 to 60 mm, as well as four geared types.

Type		Features	□20 mm	□28 mm	□42 mm	□60 mm	Driver
High-Resolution Type		A high-torque motor offering higher positioning accuracy with the basic step angle set to 0.36°/step, which is just half the basic step angle of the standard type.					
High-Torque Type		A high-torque motor generating high torque of approx. 1.3 to 1.5 times the level achieved by the standard type.					
Standard Type		The basic model in the <b>CRK</b> Series offering an optimal balance of torque, low vibration and low noise.					
Low Backlash Type	<b>TH</b> Geared Type	A geared motor achieving both low backlash and low cost.					
	<b>PL</b> Geared Type	A geared motor offering low backlash, high strength and wide gear ratios.					
Non-Backlash Type	<b>PN</b> Geared Type	A high-accuracy, high strength geared motor achieving a backlash of 3 arc minutes or less.					
	Harmonic Geared Type	A high-accuracy, backlash-free geared motor adopting a newly developed harmonic gear. It ensures high strength in a compact body.					

## Characteristics Comparison for Geared Motors

Geared Type	Features	Permissible Torque/ Maximum Torque [N·m]	Backlash [arc min]	Basic Resolution [deg/step]	Output Shaft Speed [r/min]
Low Backlash Type	 <b>TH Geared</b> (Parallel Shaft) <ul style="list-style-type: none"> <li>- A wide variety of low gear ratios for high-speed operation</li> <li>- Gear ratios: 1:3.6, 1:7.2, 1:10, 1:20, 1:30</li> </ul>	4	60	0.024	500
	 <b>PL Geared</b> (Planetary Gear) <ul style="list-style-type: none"> <li>- High permissible torque</li> <li>- A wide variety of gear ratios for selecting the desired step angle</li> <li>- Centered output shaft</li> <li>- Gear ratios: 1:5, 1:7.2, 1:10, 1:25, 1:36, 1:50</li> </ul>	8	35	0.0144	360
Non-Backlash Type	 <b>PN Geared</b> (Planetary Gear) <ul style="list-style-type: none"> <li>- High speed (low gear ratio), high positioning precision</li> <li>- High permissible/maximum torque</li> <li>- A wide variety of gear ratios for selecting the desired step angle</li> <li>- Centered output shaft</li> <li>- Gear ratios: 1:5, 1:7.2, 1:10, 1:25, 1:36, 1:50</li> </ul>	Permissible Torque 8 Maximum Torque 20	3	0.0144	600
	 <b>Harmonic Geared</b> (Harmonic Drive) <ul style="list-style-type: none"> <li>- High positioning precision</li> <li>- High permissible/maximum torque</li> <li>- High gear ratio, high resolution</li> <li>- Centered output shaft</li> <li>- Gear ratios: 1:50, 1:100</li> </ul>	Permissible Torque 8 Maximum Torque 28	0	0.0072	70

**Note:**  
 ● The values shown above must be used as reference. These values vary depending on the frame size and gear ratio.

- Introduction
- AC Input
  - Q5STEP AS
  - Q5STEP ASC
- DC Input
  - 5-Phase RK
  - 5-Phase CRK
- DC Input
  - 2-Phase CMK
  - 2-Phase CSK
- 2-Phase Stepping Motors
- 5-Phase Stepping Motors
- Controllers
- Accessories
- Installation

## System Configuration

An example of a system configuration with the **SG8030JY** controller.

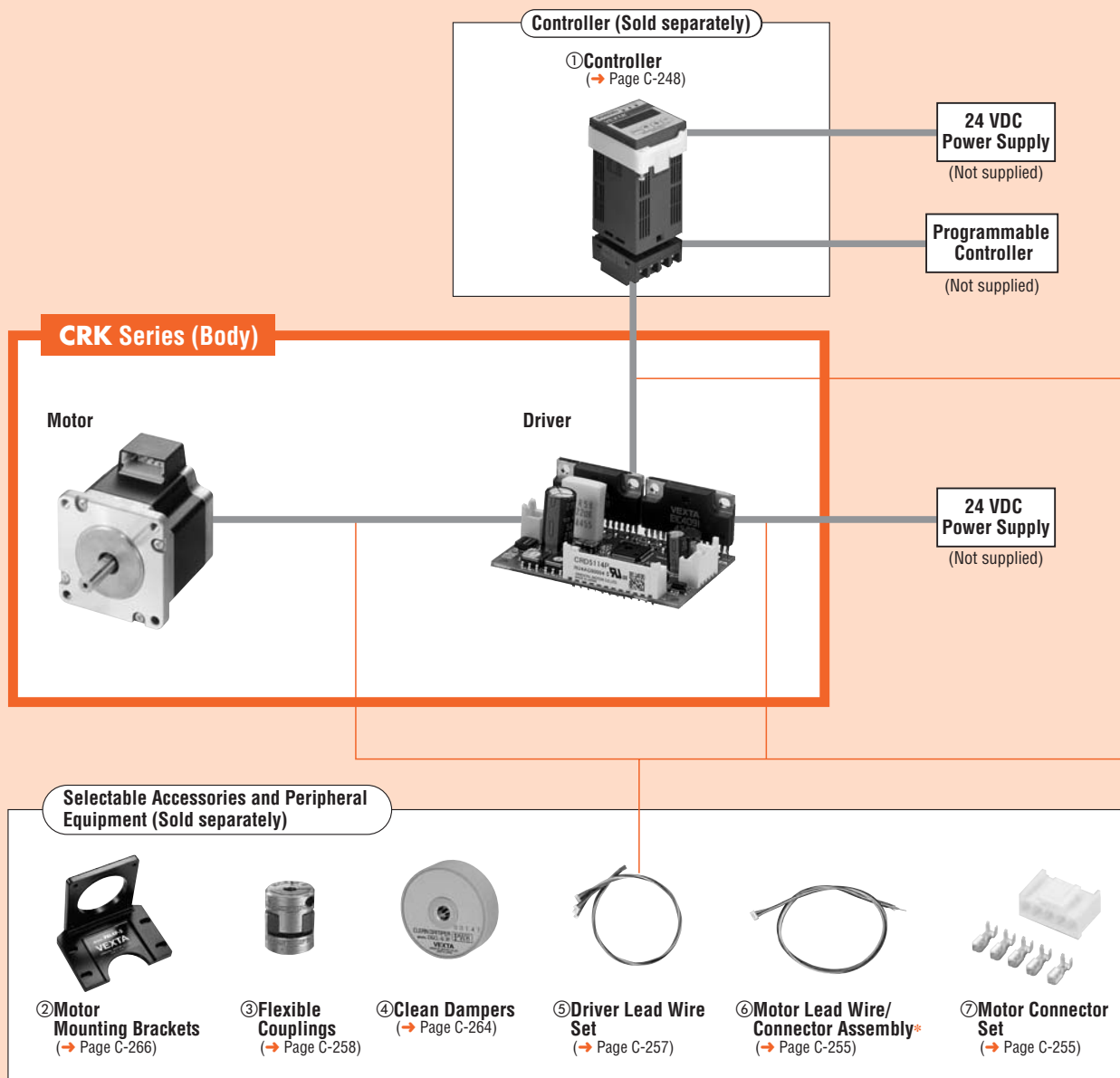

\*A motor lead wire/connector assembly of 0.6 m is included with the motor and driver package of connector-coupled type.

No.	Product Name	Overview	Page
①	Controller	This controller outputs pulse commands that determine the rotating amount and rotating speed.	C-248
②	Motor Mounting Brackets	Dedicated mounting bracket for the motor.	C-266
③	Flexible Couplings	Coupling that connects the motor shaft to the driven shaft.	C-258
④	Clean Dampers	Dedicated damper for suppressing stepping motor vibration.	C-264
⑤	Driver Lead Wire Set	Cables for connecting the driver and motor, DC power supply or host controller (0.6 m).	C-257
⑥	Motor Lead Wire/Connector Assembly	Lead wire with a connector crimped for connector-coupled motors (0.6 m, 1 m).	C-255
⑦	Motor Connector Set	Set of connector housings and contacts for use with connector-coupled motors (for 30 units).	C-255

### Example of System Configuration

(Body)

(Sold separately)

<b>CRK Series</b>	+	<b>Controller</b>	<b>Motor Mounting Bracket</b>	<b>Flexible Coupling</b>	<b>Clean Damper</b>	<b>Driver Lead Wire Set (0.6 m)</b>
<b>CRK566PMBP</b>		<b>SG8030JY-U</b>	<b>PAL2P-5</b>	<b>MCS300808</b>	<b>D6CL-8.0F</b>	<b>LCS04SD5</b>

●The system configuration shown above is an example. Other combinations are available.

## Product Number Code

High-Resolution Type/High-Torque Type/Standard Type

# CRK 5 4 4 P M A P

① ② ③ ④ ⑤ ⑥ ⑦ ⑧

Geared Type

# CRK 5 2 3 P A P-N 7.2

① ② ③ ④ ⑤ ⑥ ⑦ ⑧ ⑨

## Product Line

High-Resolution Type

Model (Single Shaft)	Model (Double Shaft)
CRK523PMAP	CRK523PMBP
CRK524PMAP	CRK524PMBP
CRK525PMAP	CRK525PMBP
CRK544PMAP	CRK544PMBP
CRK546PMAP	CRK546PMBP
CRK564PMAP	CRK564PMBP
CRK566PMAP	CRK566PMBP
CRK569PMAP	CRK569PMBP

High-Torque Type

Model (Single Shaft)	Model (Double Shaft)
CRK513PAP	CRK513PBP
CRK523PAP	CRK523PBP
CRK525PAP	CRK525PBP
CRK544PAP	CRK544PBP
CRK546PAP	CRK546PBP

Standard Type

Model (Single Shaft)	Model (Double Shaft)
CRK543AP	CRK543BP
CRK544AP	CRK544BP
CRK545AP	CRK545BP
CRK564AP	CRK564BP
CRK566AP	CRK566BP
CRK569AP	CRK569BP

TH Geared Type

Model (Single Shaft)	Model (Double Shaft)
CRK523PAP-T7.2	CRK523PBP-T7.2
CRK523PAP-T10	CRK523PBP-T10
CRK523PAP-T20	CRK523PBP-T20
CRK523PAP-T30	CRK523PBP-T30
CRK543AP-T3.6	CRK543BP-T3.6
CRK543AP-T7.2	CRK543BP-T7.2
CRK543AP-T10	CRK543BP-T10
CRK543AP-T20	CRK543BP-T20
CRK543AP-T30	CRK543BP-T30
CRK564AP-T3.6	CRK564BP-T3.6
CRK564AP-T7.2	CRK564BP-T7.2
CRK564AP-T10	CRK564BP-T10
CRK564AP-T20	CRK564BP-T20
CRK564AP-T30	CRK564BP-T30

① Series	CRK: CRK Series
② 5: 5-Phase	
③ Motor Frame Size	1: 20 mm 2: 28 mm 4: 42 mm 6: 60 mm
④ Motor Case Length	
⑤ Motor Type	
⑥ Resolution	M: High-Resolution
⑦ Motor Shaft Type	A: Single Shaft B: Double Shaft
⑧ Signal I/O Mode of Driver	P: Photocoupler

① Series	CRK: CRK Series
② 5: 5-Phase	
③ Motor Frame Size	1: 20 mm 2: 28 mm 4: 42 mm 6: 60 mm
④ Motor Case Length	
⑤ Motor Type	
⑥ Motor Shaft Typ	A: Single Shaft B: Double Shaft
⑦ Signal I/O Mode of Driver	P: Photocoupler
⑧ Gearhead Type	T: TH Geared Type P: PL Geared Type N: PN Geared Type H: Harmonic Geared Type
⑨ Gear Ratio	

PL Geared Type

Model (Single Shaft)	Model (Double Shaft)
CRK545AP-P5	CRK545BP-P5
CRK545AP-P7.2	CRK545BP-P7.2
CRK545AP-P10	CRK545BP-P10
CRK543AP-P25	CRK543BP-P25
CRK543AP-P36	CRK543BP-P36
CRK543AP-P50	CRK543BP-P50
CRK566AP-P5	CRK566BP-P5
CRK566AP-P7.2	CRK566BP-P7.2
CRK566AP-P10	CRK566BP-P10
CRK564AP-P25	CRK564BP-P25
CRK564AP-P36	CRK564BP-P36
CRK564AP-P50	CRK564BP-P50

PN Geared Type

Model (Single Shaft)	Model (Double Shaft)
CRK523PAP-N5	CRK523PBP-N5
CRK523PAP-N7.2	CRK523PBP-N7.2
CRK523PAP-N10	CRK523PBP-N10
CRK544AP-N5	CRK544BP-N5
CRK544AP-N7.2	CRK544BP-N7.2
CRK544AP-N10	CRK544BP-N10
CRK566AP-N5	CRK566BP-N5
CRK566AP-N7.2	CRK566BP-N7.2
CRK566AP-N10	CRK566BP-N10
CRK564AP-N25	CRK564BP-N25
CRK564AP-N36	CRK564BP-N36
CRK564AP-N50	CRK564BP-N50

Harmonic Geared Type

Model (Single Shaft)	Model (Double Shaft)
CRK513PAP-H50	CRK513PBP-H50
CRK513PAP-H100	CRK513PBP-H100
CRK543AP-H50	CRK543BP-H50
CRK543AP-H100	CRK543BP-H100
CRK564AP-H50	CRK564BP-H50
CRK564AP-H100	CRK564BP-H100

The following items are included in each product.

Motor, Parallel Key<sup>\*1</sup>, Driver, Driver Connector, Motor Lead Wire/Connector Assembly<sup>\*2</sup>, Operating Manual

\*1 Only for the products with a key slot on the output shaft

\*2 Only for connector-coupled motor

# High-Resolution Type Motor Frame Size 28 mm, 42 mm

## Specifications RoHS



Model	Single Shaft	<b>CRK523PMAP*</b>	<b>CRK524PMAP*</b>	<b>CRK525PMAP*</b>	<b>CRK544PMAP*</b>	<b>CRK546PMAP*</b>
	Double Shaft	<b>CRK523PMBP*</b>	<b>CRK524PMBP*</b>	<b>CRK525PMBP*</b>	<b>CRK544PMBP*</b>	<b>CRK546PMBP*</b>
Maximum Holding Torque	N·m	0.042	0.061	0.09	0.24	0.42
Rotor Inertia	J: kg·m <sup>2</sup>	$9 \times 10^{-7}$	$13 \times 10^{-7}$	$19 \times 10^{-7}$	$60 \times 10^{-7}$	$121 \times 10^{-7}$
Rated Current	A/Phase	0.35			0.75	
Basic Step Angle	0.36°					
Power Source	24 VDC ± 10% 0.7 A			24 VDC ± 10% 1.4 A		
Excitation Mode	Microstep					
Mass	Motor	kg	0.11	0.15	0.2	0.3
	Driver	kg	0.04			0.5
Dimension No.	Motor	[2]			[3]	
	Driver	[18]				

How to read specifications table → Page C-10

\* Motor lead wire/connector assembly (0.6 m) is included with the motor and driver package of connector-coupled type.

## Speed – Torque Characteristics

How to read speed – torque characteristics → Page C-10

### CRK523PMAP/CRK523PMBP

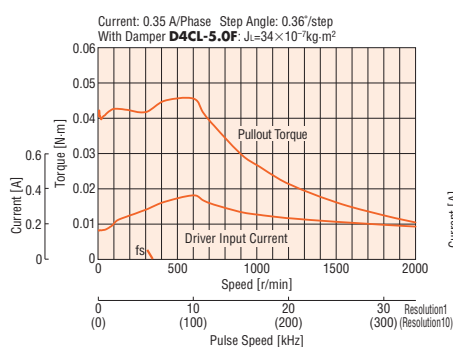

### CRK524PMAP/CRK524PMBP

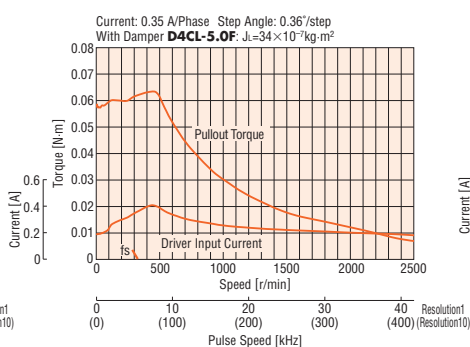

### CRK525PMAP/CRK525PMBP

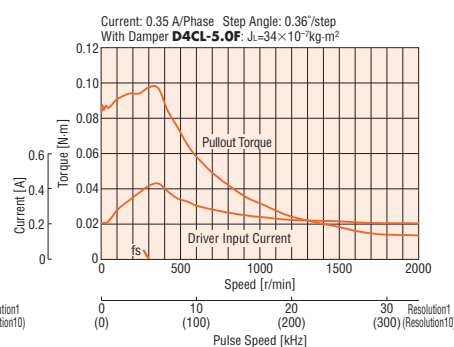

### CRK544PMAP/CRK544PMBP

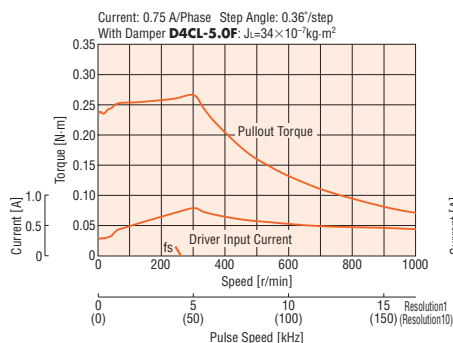

### CRK546PMAP/CRK546PMBP

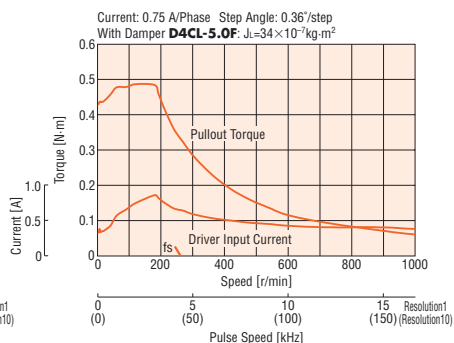

● The pulse input circuit responds to approximately 500 kHz with a pulse duty of 50%.

#### Notes:

● Pay attention to heat dissipation from motor as there will be a considerable amount of heat under certain conditions. Be sure to keep the temperature of the motor case under 100°C. (Under 75°C is required to comply with UL or CSA Standards as the motor is recognized as insulation class A.)

● The driver's automatic current cutback function at motor standstill reduces maximum holding torque by approximately 50%.

# High-Resolution Type Motor Frame Size 60 mm

## Specifications RoHS



Model	Single Shaft	<b>CRK564PMAP*</b>	<b>CRK566PMAP*</b>	<b>CRK569PMAP*</b>
	Double Shaft	<b>CRK564PMBP*</b>	<b>CRK566PMBP*</b>	<b>CRK569PMBP*</b>
Maximum Holding Torque	N·m	0.78	1.3	2.3
Rotor Inertia	J: kg·m <sup>2</sup>	320×10 <sup>-7</sup>	500×10 <sup>-7</sup>	1100×10 <sup>-7</sup>
Rated Current	A/Phase		1.4	
Basic Step Angle			0.36°	
Power Source		24 VDC ± 10% 2.5 A		
Excitation Mode		Microstep		
Mass	Motor kg	0.65	0.87	1.5
	Driver kg		0.04	
Dimension No.	Motor		4	
	Driver		18	

How to read specifications table → Page C-10

\* Motor lead wire/connector assembly (0.6 m) is included with the motor and driver package of connector-coupled type.

## Speed – Torque Characteristics

How to read speed – torque characteristics → Page C-10

### CRK564PMAP/CRK564PMBP

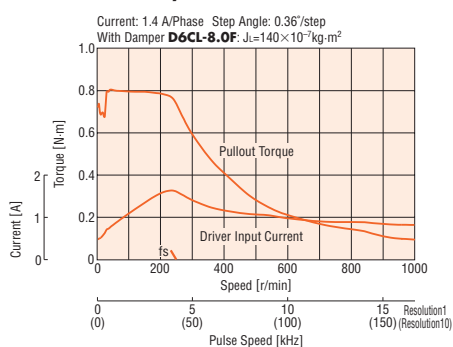

### CRK566PMAP/CRK566PMBP

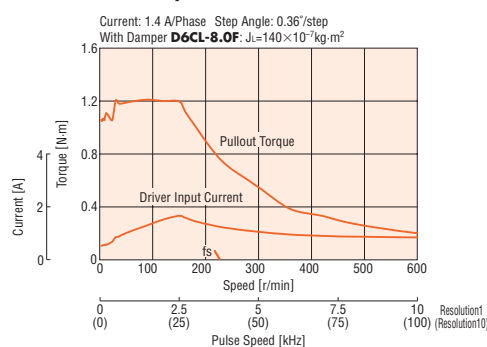

### CRK569PMAP/CRK569PMBP

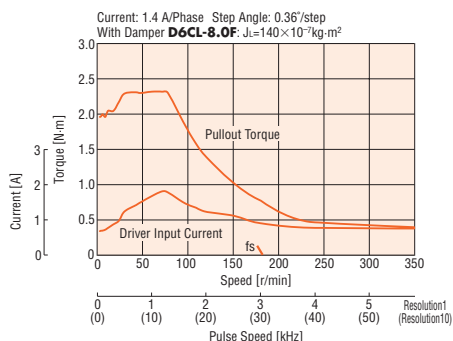

- The pulse input circuit responds to approximately 500 kHz with a pulse duty of 50%.

#### Notes:

- Pay attention to heat dissipation from motor as there will be a considerable amount of heat under certain conditions. Be sure to keep the temperature of the motor case under 100°C. (Under 75°C is required to comply with UL or CSA Standards as the motor is recognized as insulation class A.)
- The driver's automatic current cutback function at motor standstill reduces maximum holding torque by approximately 50%.

Introduction

AC Input  
Q5STEP  
ASDC Input  
Q5STEP  
ASCAC Input  
5-Phase  
RK5-Phase  
CRKDC Input  
2-Phase  
CMK2-Phase  
CSK2-Phase  
Stepping  
Motors5-Phase  
Stepping  
Motors

Controllers

Accessories

Installation



# High-Torque Type Motor Frame Size 20 mm, 28 mm, 42 mm

## Specifications RoHS



Model	Single Shaft	<b>CRK513PAP*</b>	<b>CRK523PAP*</b>	<b>CRK525PAP*</b>	<b>CRK544PAP*</b>	<b>CRK546PAP*</b>
	Double Shaft	<b>CRK513PBP*</b>	<b>CRK523PBP*</b>	<b>CRK525PBP*</b>	<b>CRK544PBP*</b>	<b>CRK546PBP*</b>
Maximum Holding Torque	N·m	0.0231	0.048	0.078	0.24	0.42
Rotor Inertia	J: kg·m <sup>2</sup>	2.6×10 <sup>-7</sup>	9×10 <sup>-7</sup>	18×10 <sup>-7</sup>	57×10 <sup>-7</sup>	114×10 <sup>-7</sup>
Rated Current	A/Phase	0.35			0.75	
Basic Step Angle		0.72°				
Power Source		24 VDC±10% 0.7 A			24 VDC±10% 1.4 A	
Excitation Mode		Microstep				
Mass	Motor kg	0.05	0.11	0.2	0.3	0.5
	Driver kg	0.04				
Dimension No.	Motor	1	2	3		
	Driver	18				

How to read specifications table → Page C-10

\* Motor lead wire/connector assembly (0.6 m) is included with the motor and driver package of connector-coupled type.

## Speed – Torque Characteristics

How to read speed – torque characteristics → Page C-10

### CRK513PAP/CRK513PBP

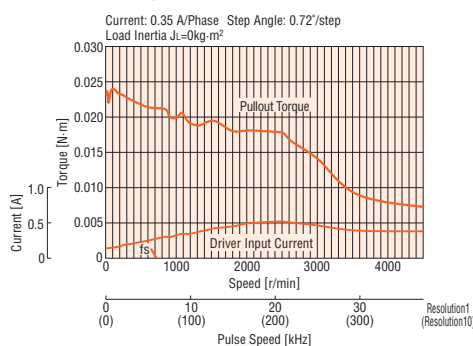

### CRK523PAP/CRK523PBP

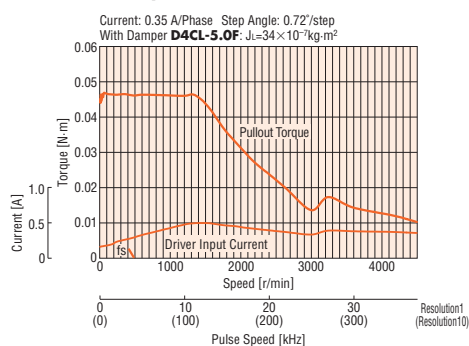

### CRK525PAP/CRK525PBP

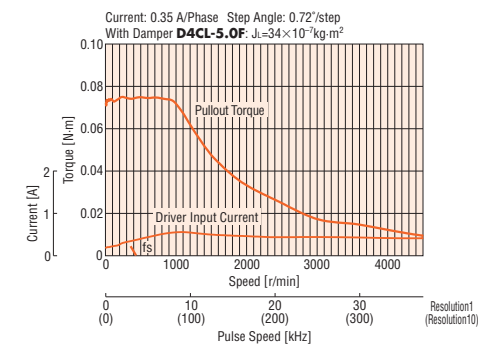

### CRK544PAP/CRK544PBP

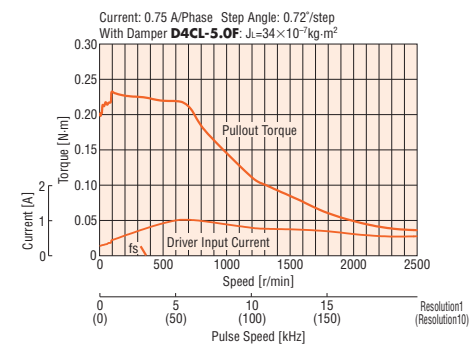

### CRK546PAP/CRK546PBP

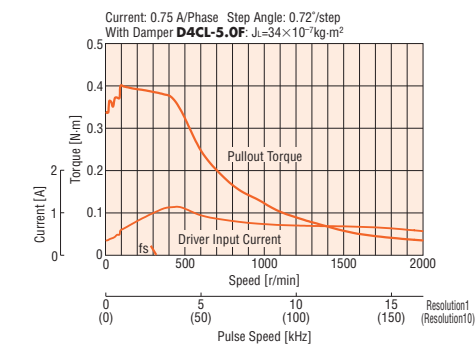

● The pulse input circuit responds to approximately 500 kHz with a pulse duty of 50%.

#### Notes:

- Pay attention to heat dissipation from motor as there will be a considerable amount of heat under certain conditions. Be sure to keep the temperature of the motor case under 100°C. (Under 75°C is required to comply with UL or CSA Standards as the motor is recognized as insulation class A.)
- The driver's automatic current cutback function at motor standstill reduces maximum holding torque by approximately 50%.

# Standard Type Motor Frame Size 42 mm, 60 mm

## Specifications RoHS



Model	Single Shaft	CRK543AP	CRK544AP	CRK545AP	CRK564AP	CRK566AP	CRK569AP
	Double Shaft	CRK543BP	CRK544BP	CRK545BP	CRK564BP	CRK566BP	CRK569BP
Maximum Holding Torque	N·m	0.13	0.18	0.24	0.42	0.83	1.66
Rotor Inertia	J: kg·m <sup>2</sup>	35×10 <sup>-7</sup>	54×10 <sup>-7</sup>	68×10 <sup>-7</sup>	175×10 <sup>-7</sup>	280×10 <sup>-7</sup>	560×10 <sup>-7</sup>
Rated Current	A/Phase	0.75			1.4		
Basic Step Angle		0.72°					
Power Source		24 VDC±10% 1.4 A			24 VDC±10% 2.5 A		
Excitation Mode		Microstep					
Mass	Motor kg	0.21	0.27	0.35	0.6	0.8	1.3
	Driver kg	0.04					
Dimension No.	Motor	[5]			[6]		
	Driver	[18]					

How to read specifications table → Page C-10

## Speed – Torque Characteristics

How to read speed – torque characteristics → Page C-10

### CRK543AP/CRK543BP

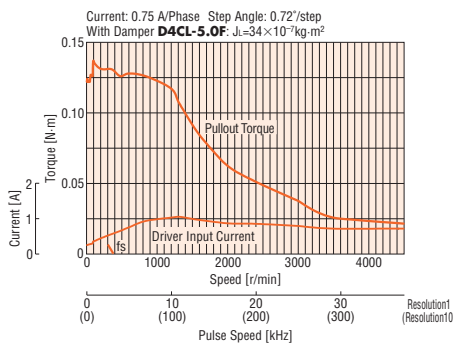

### CRK544AP/CRK544BP

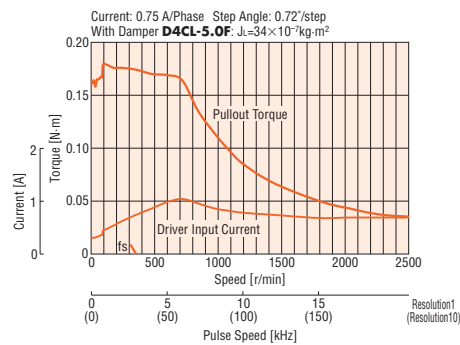

### CRK545AP/CRK545BP

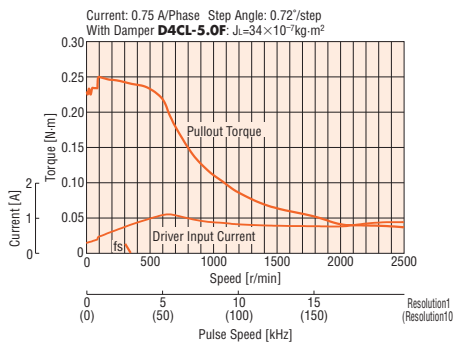

### CRK564AP/CRK564BP

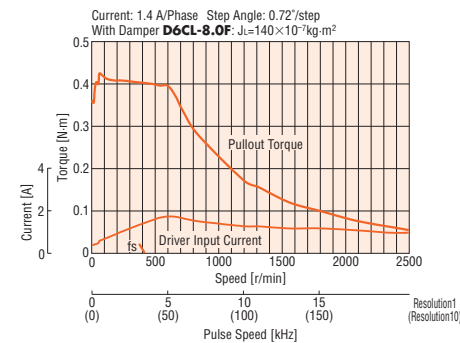

### CRK566AP/CRK566BP

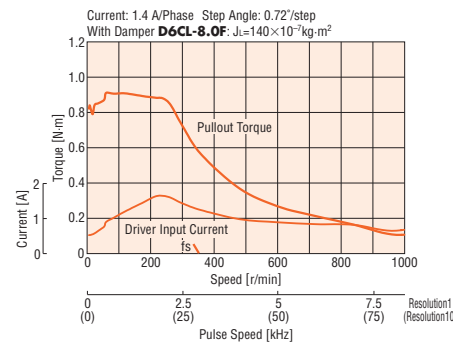

### CRK569AP/CRK569BP

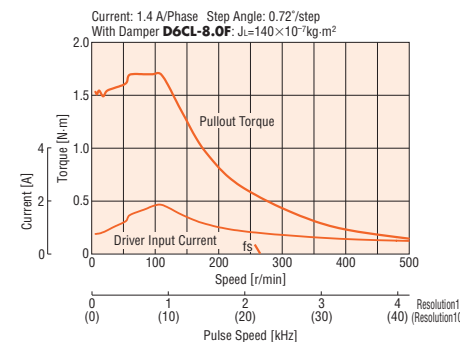

● The pulse input circuit responds to approximately 500 kHz with a pulse duty of 50%.

#### Notes:

- Pay attention to heat dissipation from motor as there will be a considerable amount of heat under certain conditions. Be sure to keep the temperature of the motor case under 100°C. (Under 75°C is required to comply with UL or CSA Standards as the motor is recognized as insulation class A.)
- The driver's automatic current cutback function at motor standstill reduces maximum holding torque by approximately 50%.

# TH Geared Type Motor Frame Size 28 mm

## Specifications RoHS



Model	Single Shaft	<b>CRK523PAP-T7.2*</b>	<b>CRK523PAP-T10*</b>	<b>CRK523PAP-T20*</b>	<b>CRK523PAP-T30*</b>
	Double Shaft	<b>CRK523PBP-T7.2*</b>	<b>CRK523PBP-T10*</b>	<b>CRK523PBP-T20*</b>	<b>CRK523PBP-T30*</b>
Maximum Holding Torque	N·m	0.2	0.3	0.4	0.5
Rotor Inertia	J: kg·m <sup>2</sup>	9×10 <sup>-7</sup>			
Rated Current	A/Phase	0.35			
Basic Step Angle		0.1°	0.072°	0.036°	0.024°
Gear Ratio		1 : 7.2	1 : 10	1 : 20	1 : 30
Permissible Torque	N·m	0.2	0.3	0.4	0.5
Backlash	arc minute (degrees)	60 (1°)			
Permissible Speed Range	r/min	0~416	0~300	0~150	0~100
Power Source		24 VDC±10% 0.7 A			
Excitation Mode		Microstep			
Mass	Motor	kg			
	Driver	kg			
Dimension No.	Motor	7			
	Driver	18			

How to read specifications table → Page C-10

\* Motor lead wire/connector assembly (0.6 m) is included with the motor and driver package of connector-coupled type.

**Note:**

● Direction of rotation of the motor and that of the gear output shaft are the opposite for the gear ratios 1:7.2 and 1:10. It is the same for 1:20 and 1:30 gear ratios.

## Speed – Torque Characteristics

How to read speed – torque characteristics → Page C-10

### CRK523PAP-T7.2/CRK523PBP-T7.2

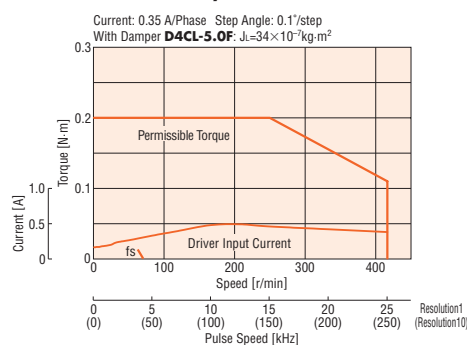

### CRK523PAP-T10/CRK523PBP-T10

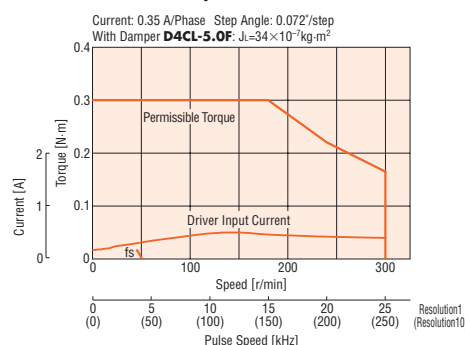

### CRK523PAP-T20/CRK523PBP-T20

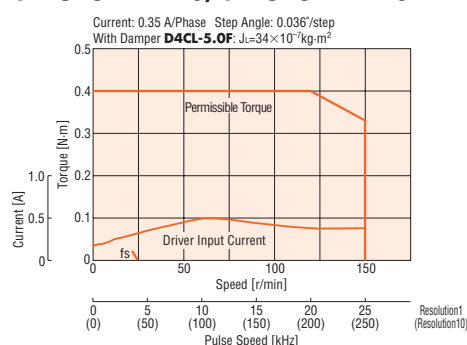

### CRK523PAP-T30/CRK523PBP-T30

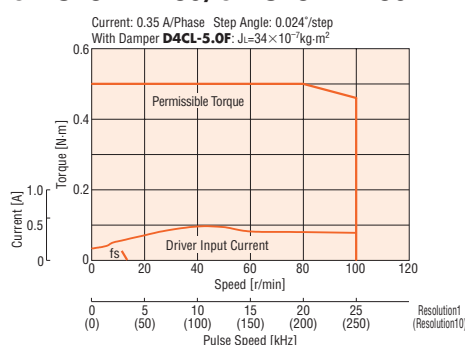

● The pulse input circuit responds to approximately 500 kHz with a pulse duty of 50%.

**Notes:**

- Pay attention to heat dissipation from motor as there will be a considerable amount of heat under certain conditions. Be sure to keep the temperature of the motor case under 100°C. (Under 75°C is required to comply with UL or CSA Standards as the motor is recognized as insulation class A.)
- The driver's automatic current cutback function at motor standstill reduces maximum holding torque by approximately 50%.

# TH Geared Type Motor Frame Size 42 mm

## Specifications RoHS



Model	Single Shaft	CRK543AP-T3.6	CRK543AP-T7.2	CRK543AP-T10	CRK543AP-T20	CRK543AP-T30
	Double Shaft	CRK543BP-T3.6	CRK543BP-T7.2	CRK543BP-T10	CRK543BP-T20	CRK543BP-T30
Maximum Holding Torque	N·m	0.35	0.7	1	1.5	
Rotor Inertia	J: kg·m <sup>2</sup>	35×10 <sup>-7</sup>				
Rated Current	A/Phase	0.75				
Basic Step Angle		0.2°	0.1°	0.072°	0.036°	0.024°
Gear Ratio		1 : 3.6	1 : 7.2	1 : 10	1 : 20	1 : 30
Permissible Torque	N·m	0.35	0.7	1	1.5	
Backlash	arc minute (degrees)	45 (0.75°)	25 (0.417°)		15 (0.25°)	
Permissible Speed Range	r/min	0~500	0~250	0~180	0~90	0~60
Power Source		24 VDC ± 10% 1.4 A				
Excitation Mode		Microstep				
Mass	Motor	kg				
	Driver	kg				
Dimension No.	Motor	[8]				
	Driver	[18]				

How to read specifications table → Page C-10

### Note:

- Direction of rotation of the motor and that of the gear output shaft are the same for the gear ratios 1:3.6, 1:7.2 and 1:10. It is the opposite for 1:20 and 1:30 gear ratios.

## Speed – Torque Characteristics

How to read speed – torque characteristics → Page C-10

### CRK543AP-T3.6/CRK543BP-T3.6

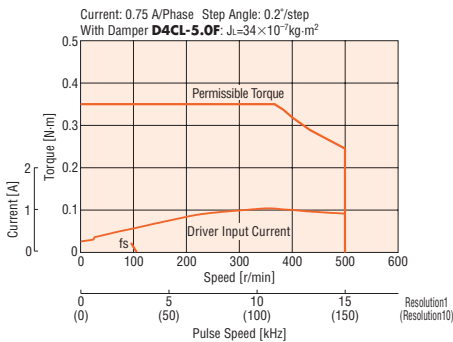

### CRK543AP-T7.2/CRK543BP-T7.2

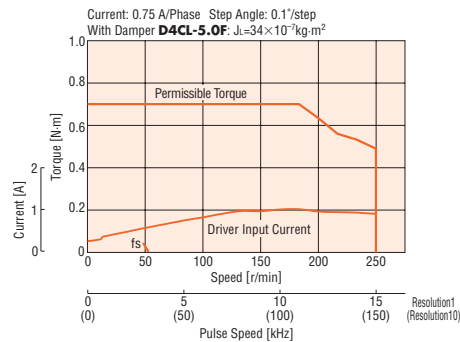

### CRK543AP-T10/CRK543BP-T10

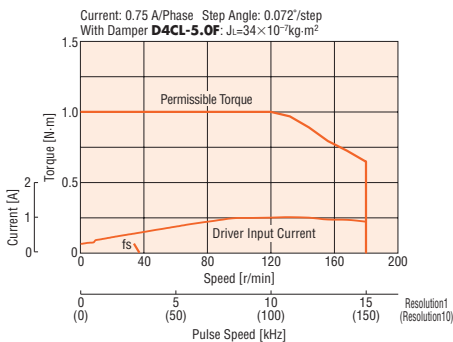

### CRK543AP-T20/CRK543BP-T20

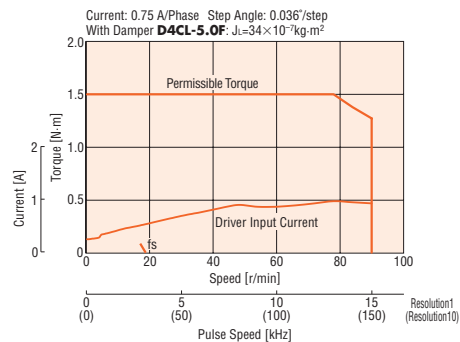

### CRK543AP-T30/CRK543BP-T30

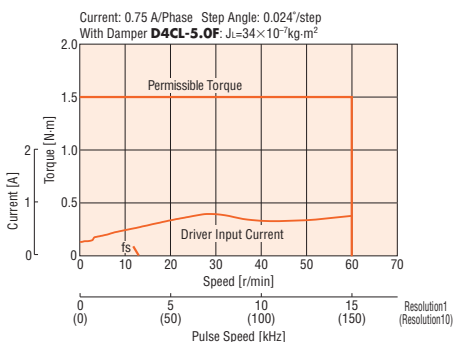

- The pulse input circuit responds to approximately 500 kHz with a pulse duty of 50%.

### Notes:

- Pay attention to heat dissipation from motor as there will be a considerable amount of heat under certain conditions. Be sure to keep the temperature of the motor case under 100°C. (Under 75°C is required to comply with UL or CSA Standards as the motor is recognized as insulation class A.)
- The driver's automatic current cutback function at motor standstill reduces maximum holding torque by approximately 50%.

# TH Geared Type Motor Frame Size 60 mm

## Specifications RoHS



Model	Single Shaft	<b>CRK564AP-T3.6</b>	<b>CRK564AP-T7.2</b>	<b>CRK564AP-T10</b>	<b>CRK564AP-T20</b>	<b>CRK564AP-T30</b>
	Double Shaft	<b>CRK564BP-T3.6</b>	<b>CRK564BP-T7.2</b>	<b>CRK564BP-T10</b>	<b>CRK564BP-T20</b>	<b>CRK564BP-T30</b>
Maximum Holding Torque	N·m	1.25	2.5	3	3.5	4
Rotor Inertia	J: kg·m <sup>2</sup>	175×10 <sup>-7</sup>				
Rated Current	A/Phase	1.4				
Basic Step Angle		0.2°	0.1°	0.072°	0.036°	0.024°
Gear Ratio		1 : 3.6	1 : 7.2	1 : 10	1 : 20	1 : 30
Permissible Torque	N·m	1.25	2.5	3	3.5	4
Backlash	arc minute (degrees)	15 (0.25°)			10 (0.167°)	
Permissible Speed Range	r/min	0~500	0~250	0~180	0~90	0~60
Power Source		24 VDC±10% 2.5 A				
Excitation Mode		Microstep				
Mass	Motor	kg				
	Driver	kg				
Dimension No.	Motor	[9]				
	Driver	[18]				

How to read specifications table → Page C-10

### Note:

- Direction of rotation of the motor and that of the gear output shaft are the same for the gear ratios 1:3.6, 1:7.2 and 1:10. It is the opposite for 1:20 and 1:30 gear ratios.

## Speed – Torque Characteristics

How to read speed – torque characteristics → Page C-10

### CRK564AP-T3.6/CRK564BP-T3.6

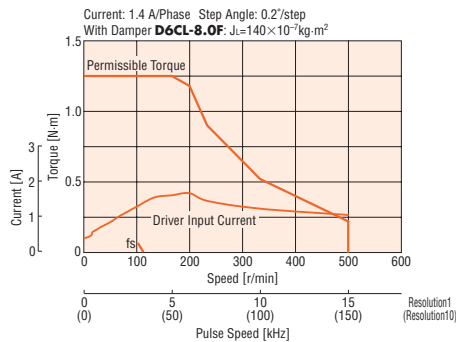

### CRK564AP-T7.2/CRK564BP-T7.2

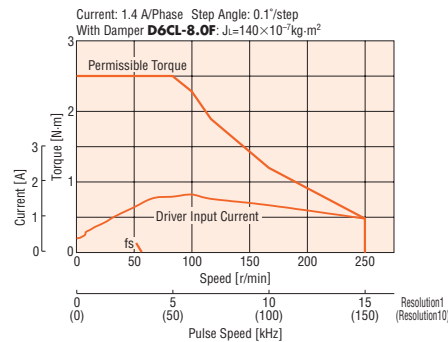

### CRK564AP-T10/CRK564BP-T10

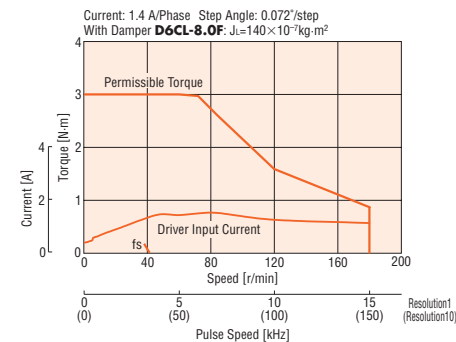

### CRK564AP-T20/CRK564BP-T20

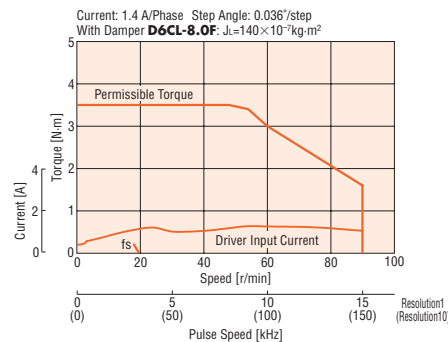

### CRK564AP-T30/CRK564BP-T30

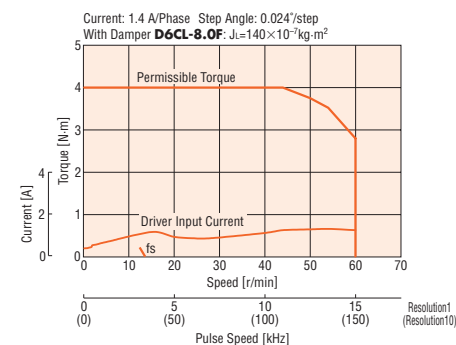

- The pulse input circuit responds to approximately 500 kHz with a pulse duty of 50%.

### Notes:

- Pay attention to heat dissipation from motor as there will be a considerable amount of heat under certain conditions. Be sure to keep the temperature of the motor case under 100°C. (Under 75°C is required to comply with UL or CSA Standards as the motor is recognized as insulation class A.)
- The driver's automatic current cutback function at motor standstill reduces maximum holding torque by approximately 50%.

# PL Geared Type Motor Frame Size 42 mm

## Specifications RoHS



Model	Single Shaft	CRK545AP-P5	CRK545AP-P7.2	CRK545AP-P10	CRK543AP-P25	CRK543AP-P36	CRK543AP-P50
	Double Shaft	CRK545BP-P5	CRK545BP-P7.2	CRK545BP-P10	CRK543BP-P25	CRK543BP-P36	CRK543BP-P50
Maximum Holding Torque	N·m	1	1.5	2.5	2.5	3	3
Rotor Inertia	J: kg·m <sup>2</sup>	68×10 <sup>-7</sup>			35×10 <sup>-7</sup>		
Rated Current	A/Phase	0.75					
Basic Step Angle		0.144°	0.1°	0.072°	0.0288°	0.02°	0.0144°
Gear Ratio		1 : 5	1 : 7.2	1 : 10	1 : 25	1 : 36	1 : 50
Permissible Torque	N·m	1	1.5	2.5	2.5	3	3
Backlash	arc minute (degrees)	35 (0.58°)					
Permissible Speed Range	r/min	0~360	0~250	0~180	0~72	0~50	0~36
Power Source		24 VDC±10% 1.4 A					
Excitation Mode		Microstep					
Mass	Motor	0.58			0.55		
	Driver				0.04		
Dimension No.	Motor	10					
	Driver	18					

How to read specifications table → Page C-10

### Note:

- Direction of rotation of the motor and that of the gear output shaft are the same.

## Speed – Torque Characteristics

How to read speed – torque characteristics → Page C-10

### CRK545AP-P5/CRK545BP-P5

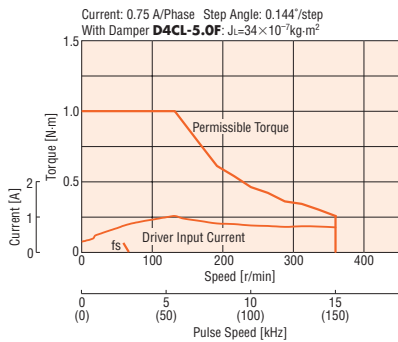

### CRK545AP-P7.2/CRK545BP-P7.2

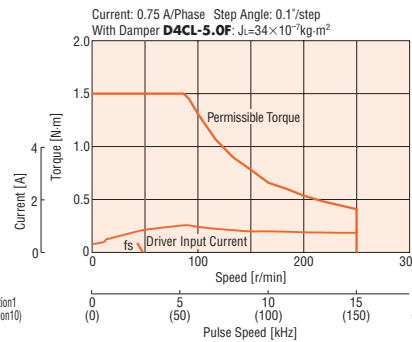

### CRK545AP-P10/CRK545BP-P10

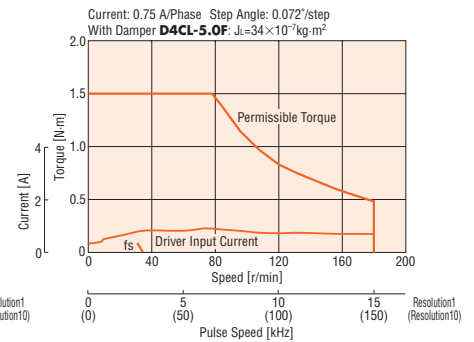

### CRK543AP-P25/CRK543BP-P25

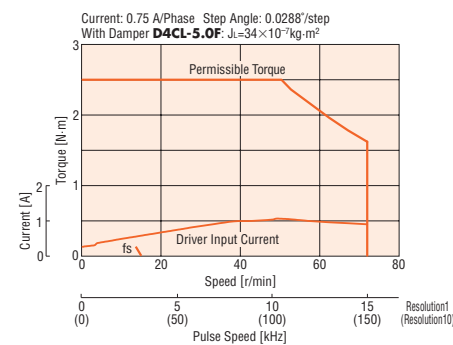

### CRK543AP-P36/CRK543BP-P36

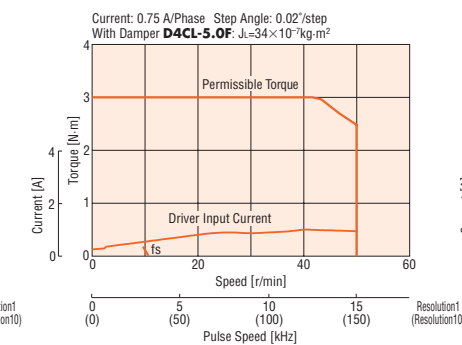

### CRK543AP-P50/CRK543BP-P50

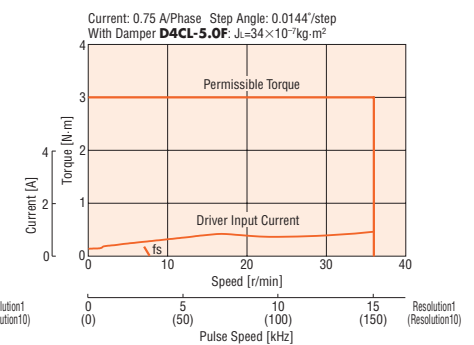

- The pulse input circuit responds to approximately 500 kHz with a pulse duty of 50%.

### Notes:

- Pay attention to heat dissipation from motor as there will be a considerable amount of heat under certain conditions. Be sure to keep the temperature of the motor case under 100°C. (Under 75°C is required to comply with UL or CSA Standards as the motor is recognized as insulation class A.)
- The driver's automatic current cutback function at motor standstill reduces maximum holding torque by approximately 50%.

# PL Geared Type Motor Frame Size 60 mm

## Specifications RoHS



Model	Single Shaft	<b>CRK566AP-P5</b>	<b>CRK566AP-P7.2</b>	<b>CRK566AP-P10</b>	<b>CRK564AP-P25</b>	<b>CRK564AP-P36</b>	<b>CRK564AP-P50</b>
	Double Shaft	<b>CRK566BP-P5</b>	<b>CRK566BP-P7.2</b>	<b>CRK566BP-P10</b>	<b>CRK564BP-P25</b>	<b>CRK564BP-P36</b>	<b>CRK564BP-P50</b>
Maximum Holding Torque	N·m	3.5	4	5	8		
Rotor Inertia	J: kg·m <sup>2</sup>	280×10 <sup>-7</sup>			175×10 <sup>-7</sup>		
Rated Current	A/Phase	1.4					
Basic Step Angle		0.144°	0.1°	0.072°	0.0288°	0.02°	0.0144°
Gear Ratio		1 : 5	1 : 7.2	1 : 10	1 : 25	1 : 36	1 : 50
Permissible Torque	N·m	3.5	4	5	8		
Backlash	arc minute (degrees)	20 (0.33°)					
Permissible Speed Range	r/min	0~360	0~250	0~180	0~72	0~50	0~36
Power Source		24 VDC±10% 2.5 A					
Excitation Mode		Microstep					
Mass	Motor kg	1.3			1.4		
	Driver kg	0.04					
Dimension No.	Motor	<span style="border: 1px solid black; padding: 1px;">11</span>					
	Driver	<span style="border: 1px solid black; padding: 1px;">18</span>					

How to read specifications table → Page C-10

### Note:

- Direction of rotation of the motor and that of the gear output shaft are the same.

## Speed – Torque Characteristics

How to read speed – torque characteristics → Page C-10

### CRK566AP-P5/CRK566BP-P5

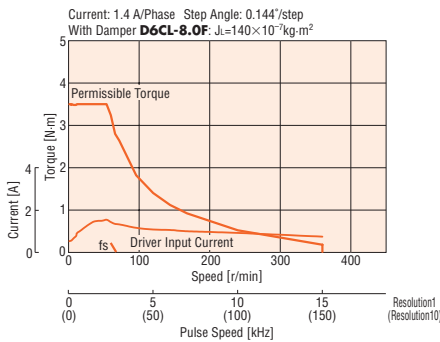

### CRK566AP-P7.2/CRK566BP-P7.2

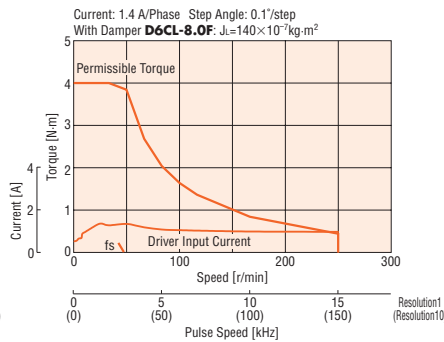

### CRK566AP-P10/CRK566BP-P10

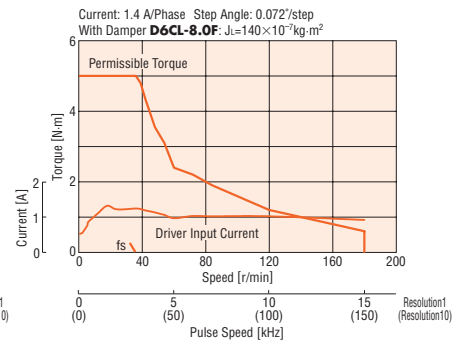

### CRK564AP-P25/CRK564BP-P25

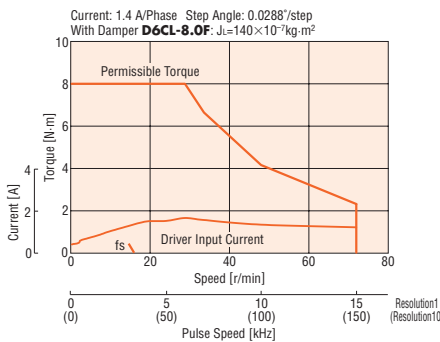

### CRK564AP-P36/CRK564BP-P36

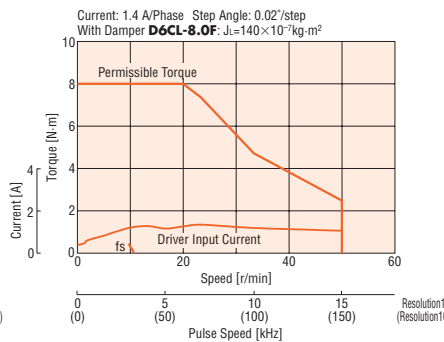

### CRK564AP-P50/CRK564BP-P50

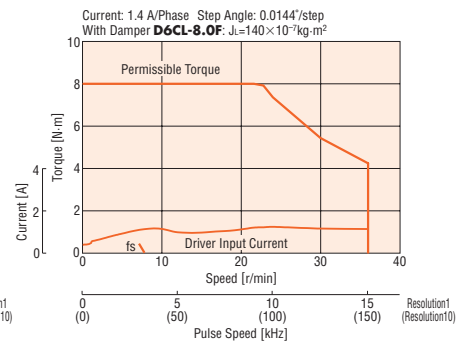

- The pulse input circuit responds to approximately 500 kHz with a pulse duty of 50%.

### Notes:

- Pay attention to heat dissipation from motor as there will be a considerable amount of heat under certain conditions. Be sure to keep the temperature of the motor case under 100°C. (Under 75°C is required to comply with UL or CSA Standards as the motor is recognized as insulation class A.)
- The driver's automatic current cutback function at motor standstill reduces maximum holding torque by approximately 50%.

# PN Geared Type Motor Frame Size 28 mm, 42 mm

## Specifications RoHS



Model	Single Shaft	CRK523PAP-N5*1	CRK523PAP-N7.2*1	CRK523PAP-N10*1	CRK544AP-N5	CRK544AP-N7.2	CRK544AP-N10
	Double Shaft	CRK523PBP-N5*1	CRK523PBP-N7.2*1	CRK523PBP-N10*1	CRK544BP-N5	CRK544BP-N7.2	CRK544BP-N10
Maximum Holding Torque	N·m	0.2	0.3	0.4	0.8	1.2	1.5
Rotor Inertia	J: kg·m <sup>2</sup>	9×10 <sup>-7</sup>			54×10 <sup>-7</sup>		
Rated Current	A/Phase	0.35			0.75		
Basic Step Angle		0.144°	0.1°	0.072°	0.144°	0.1°	0.072°
Gear Ratio		1 : 5	1 : 7.2	1 : 10	1 : 5	1 : 7.2	1 : 10
Permissible Torque	N·m	0.2	0.3	0.4	0.8	1.2	1.5
Maximum Torque*2	N·m	0.5			1.5		
Backlash	arc minute (degrees)	3 (0.05°)			2 (0.034°)		
Angular Transmission Error	arc minute (degrees)	6 (0.1°)					
Permissible Speed Range	r/min	0~600	0~416	0~300	0~600	0~416	0~300
Power Source		24 VDC±10% 0.7 A			24 VDC±10% 1.4 A		
Excitation Mode		Microstep					
Mass	Motor	kg			kg		
	Driver	0.25			0.56		
Dimension No.	Motor	[12]			[13]		
	Driver	[18]					

How to read specifications table → Page C-10

\*1 Motor lead wire/connector assembly (0.6 m) is included with the motor and driver package of connector-coupled type.

\*2 The value of maximum torque is for gear. For output torque for geared motor, see the speed – torque characteristics.

### Note:

- Direction of rotation of the motor and that of the gear output shaft are the same.

## Speed – Torque Characteristics

How to read speed – torque characteristics → Page C-10

### CRK523PAP-N5/CRK523PBP-N5

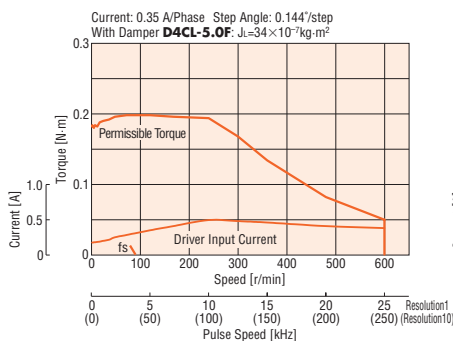

### CRK523PAP-N7.2/CRK523PBP-N7.2

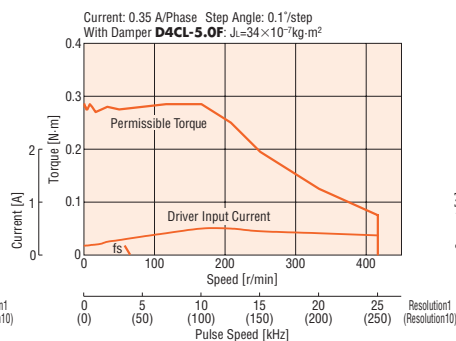

### CRK523PAP-N10/CRK523PBP-N10

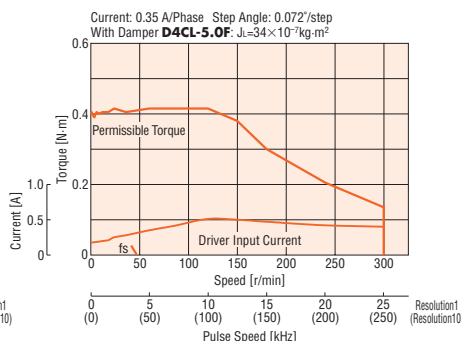

### CRK544AP-N5/CRK544BP-N5

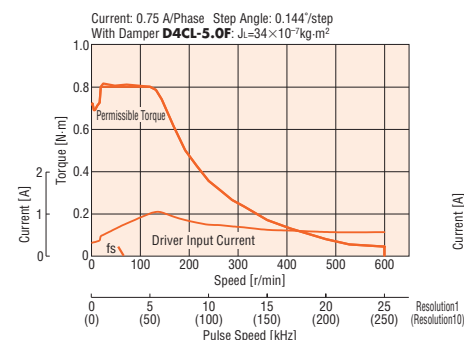

### CRK544AP-N7.2/CRK544BP-N7.2

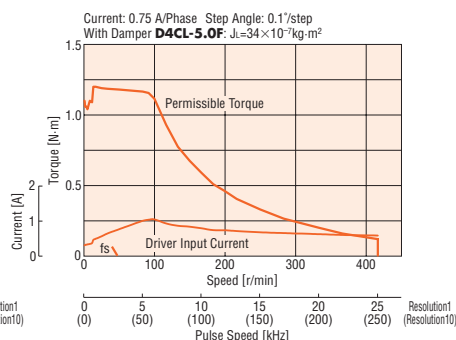

### CRK544AP-N10/CRK544BP-N10

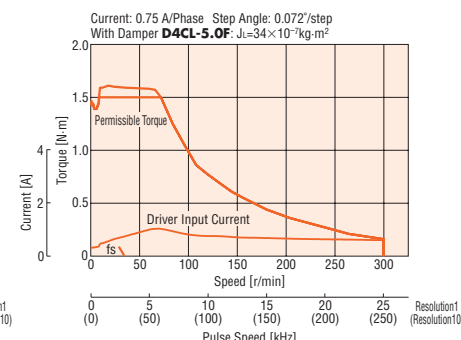

- The pulse input circuit responds to approximately 500 kHz with a pulse duty of 50%.

### Notes:

- Pay attention to heat dissipation from motor as there will be a considerable amount of heat under certain conditions. Be sure to keep the temperature of the motor case under 100°C. (Under 75°C is required to comply with UL or CSA Standards as the motor is recognized as insulation class A.)
- The driver's automatic current cutback function at motor standstill reduces maximum holding torque by approximately 50%.



# PN Geared Type Motor Frame Size 60 mm

## Specifications RoHS



Model	Single Shaft	<b>CRK566AP-N5</b>	<b>CRK566AP-N7.2</b>	<b>CRK566AP-N10</b>	<b>CRK564AP-N25</b>	<b>CRK564AP-N36</b>	<b>CRK564AP-N50</b>
	Double Shaft	<b>CRK566BP-N5</b>	<b>CRK566BP-N7.2</b>	<b>CRK566BP-N10</b>	<b>CRK564BP-N25</b>	<b>CRK564BP-N36</b>	<b>CRK564BP-N50</b>
Maximum Holding Torque	N·m	3.5	4	5	8		
Rotor Inertia	J: kg·m <sup>2</sup>	280×10 <sup>-7</sup>			175×10 <sup>-7</sup>		
Rated Current	A/Phase	1.4					
Basic Step Angle		0.144°	0.1°	0.072°	0.0288°	0.02°	0.0144°
Gear Ratio		1 : 5	1 : 7.2	1 : 10	1 : 25	1 : 36	1 : 50
Permissible Torque	N·m	3.5	4	5	8		
Maximum Torque*	N·m	7	9	11	16	20	
Backlash	arc minute (degrees)	2 (0.034°)			3 (0.05°)		
Angular Transmission Error	arc minute (degrees)	5 (0.084°)					
Permissible Speed Range	r/min	0~600	0~416	0~300	0~120	0~83	0~60
Power Source		24 VDC±10% 2.5 A					
Excitation Mode		Microstep					
Mass	Motor	kg					
	Driver	kg					
Dimension No.	Motor	□14					
	Driver	□18					

How to read specifications table → Page C-10

\*The value of maximum torque is for gear. For output torque for geared motor, see the speed – torque characteristics.

### Note:

- Direction of rotation of the motor and that of the gear output shaft are the same.

## Speed – Torque Characteristics How to read speed – torque characteristics → Page C-10

### CRK566AP-N5/CRK566BP-N5

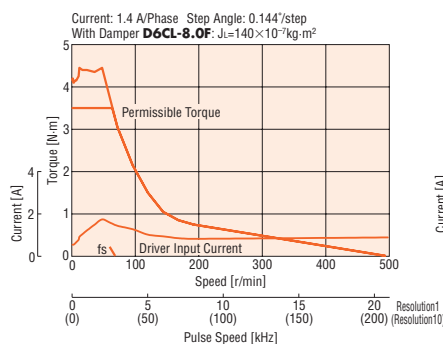

### CRK566AP-N7.2/CRK566BP-N7.2

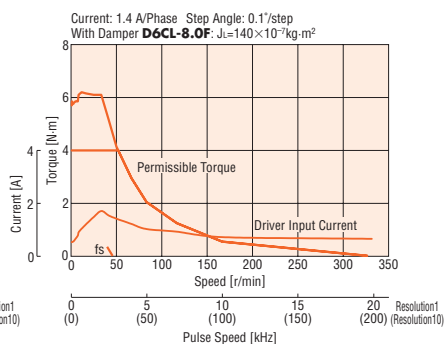

### CRK566AP-N10/CRK566BP-N10

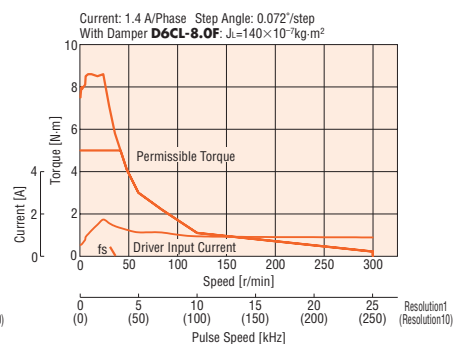

### CRK564AP-N25/CRK564BP-N25

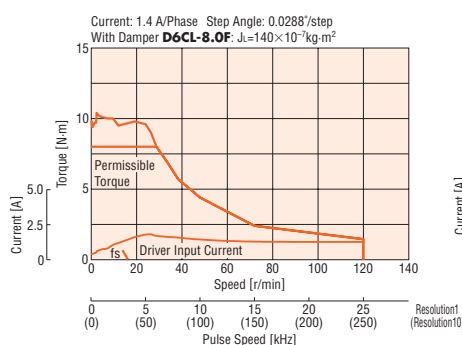

### CRK564AP-N36/CRK564BP-N36

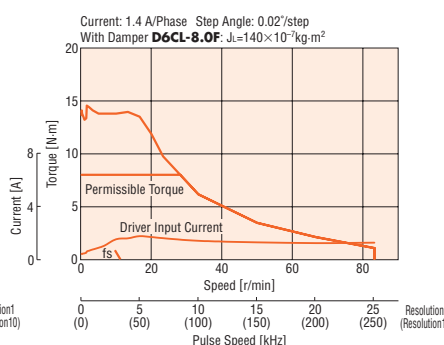

### CRK564AP-N50/CRK564BP-N50

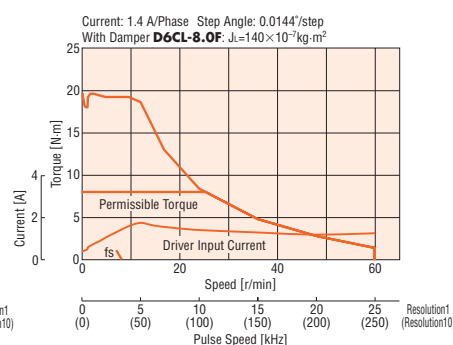

- The pulse input circuit responds to approximately 500 kHz with a pulse duty of 50%.

### Notes:

- Pay attention to heat dissipation from motor as there will be a considerable amount of heat under certain conditions. Be sure to keep the temperature of the motor case under 100°C. (Under 75°C is required to comply with UL or CSA Standards as the motor is recognized as insulation class A.)
- The driver's automatic current cutback function at motor standstill reduces maximum holding torque by approximately 50%.

# Harmonic Geared Type Motor Frame Size 20 mm, 42 mm, 60 mm

## Specifications RoHS



Model	Single Shaft	CRK513PAP-H50*	CRK513PAP-H100*	CRK543AP-H50	CRK543AP-H100	CRK564AP-H50	CRK564AP-H100
	Double Shaft	CRK513PBP-H50*	CRK513PBP-H100*	CRK543BP-H50	CRK543BP-H100	CRK564BP-H50	CRK564BP-H100
Maximum Holding Torque	N·m	0.4	0.6	3.5	5	5.5	8
Rotor Inertia	J: kg·m <sup>2</sup>	3.1×10 <sup>-7</sup>		52×10 <sup>-7</sup>		210×10 <sup>-7</sup>	
Rated Current	A/Phase	0.35		0.75		1.4	
Basic Step Angle		0.0144°	0.0072°	0.0144°	0.0072°	0.0144°	0.0072°
Gear Ratio		1 : 50	1 : 100	1 : 50	1 : 100	1 : 50	1 : 100
Permissible Torque	N·m	0.4	0.6	3.5	5	5.5	8
Maximum Torque*	N·m	0.9	1.4	8.3	11	18	28
Lost Motion (Load Torque)	arc minute	2 max. (±0.02 N·m)	2 max. (±0.03 N·m)	1.5 max. (±0.16 N·m)	1.5 max. (±0.2 N·m)	0.7 max. (±0.28 N·m)	0.7 max. (±0.39 N·m)
Permissible Speed Range	r/min	0~90	0~45	0~70	0~35	0~70	0~35
Power Source		24 VDC±10%	0.7 A	24 VDC±10%	1.4 A	24 VDC±10%	2.5 A
Excitation Mode		Microstep					
Mass	Motor	0.08		0.46		1.08	
	Driver			0.04			
Dimension No.	Motor	[15]		[16]		[17]	
	Driver			[18]			

How to read specifications table → Page C-10

\*1 Motor lead wire/connector assembly (0.6 m) is included with the motor and driver package of connector-coupled type.

\*2 The value of maximum torque is for gear. For output torque for geared motor, see the speed – torque characteristics.

### Notes:

- The inertia represents a sum of the inertia of the harmonic gear converted to a motor shaft value, and the rotor inertia.
- Direction of rotation of the motor and that of the gear output shaft are the opposite.

## Speed – Torque Characteristics

How to read speed – torque characteristics → Page C-10

### CRK513PAP-H50/CRK513PBP-H50

### CRK513PAP-H100/CRK513PBP-H100

### CRK543AP-H50/CRK543BP-H50

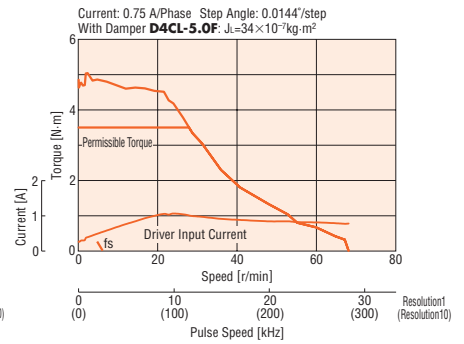
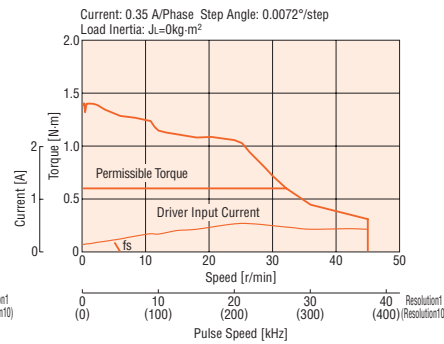
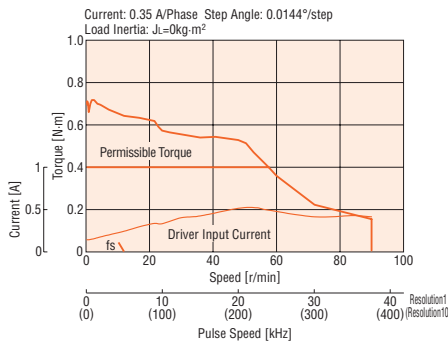

### CRK543AP-H100/CRK543BP-H100

### CRK564AP-H50/CRK564BP-H50

### CRK564AP-H100/CRK564BP-H100

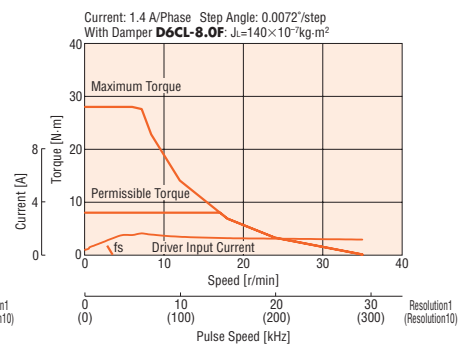
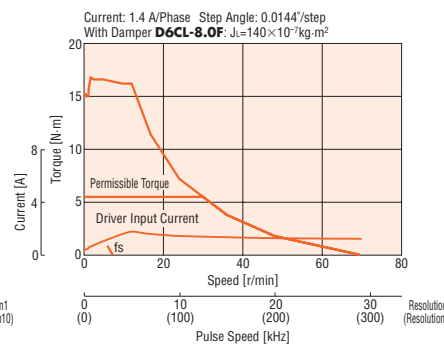
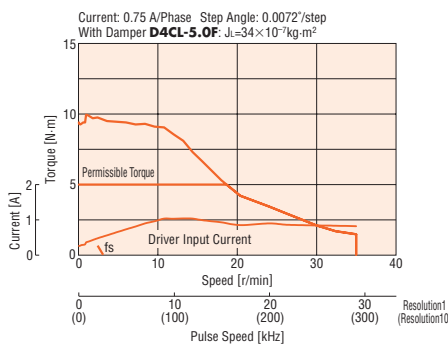

- The pulse input circuit responds to approximately 500 kHz with a pulse duty of 50%.

### Notes:

- Pay attention to heat dissipation from motor as there will be a considerable amount of heat under certain conditions. Be sure to keep the temperature of the motor case under 100°C. (Under 75°C is required to comply with UL or CSA Standards as the motor is recognized as insulation class A.)
- In order to prevent fatigue of the gear grease in the harmonic gear, keep the temperature of the gear case under 70°C.
- The driver's automatic current cutback function at motor standstill reduces maximum holding torque by approximately 50%.

## Common to Each Type

## Driver Specifications

Input Signals	Input Mode	Photocoupler input, Input resistance: 220 Ω, Input current: 10~20 mA Photocoupler ON: +4.5~5.25 V, Photocoupler OFF: 0~+1 V (Voltage between terminals)
	Pulse Signal (CW Pulse Signal)	Operation command pulse signal (CW direction operation command pulse signal when in 2-pulse input mode) Negative logic pulse input Pulse width: 1 μs minimum; Pulse rise/fall: 2 μs maximum, Pulse duty: 50% and below The motor moves one step when the pulse input is switched from photocoupler ON to OFF. Maximum input pulse frequency: 500 kHz (when the pulse duty is 50%)
	Rotation Direction Signal (CCW Pulse Signal)	Rotation direction signal Photocoupler ON: CW, Photocoupler OFF: CCW [CCW direction operation command pulse signal when in 2-pulse input mode, Negative logic pulse input] Pulse width: 1 μs minimum; Pulse rise/fall: 2 μs maximum, Pulse duty: 50% and below The motor moves one step when the pulse input is switched from photocoupler ON to OFF. Maximum input pulse frequency: 500 kHz (when the pulse duty is 50%)
	All Windings Off Signal	When in the "photocoupler ON" state, the output current to the motor is cut off and the motor shaft can be rotated manually. When in the "photocoupler OFF" state, the output current is supplied to the motor.
	Step Angle Select Signal	Step angle specified by DATA1 when photocoupler OFF, Step angle specified by DATA2 when photocoupler ON
	Current Cutback Release Signal	When in the "photocoupler ON" state, the automatic current cutback function will not be activated even after the motor stops. When in the "photocoupler OFF" state, the automatic current cutback function will be activated after the motor stops (after approx. 100 ms).
Output Signals	Output Mode	Photocoupler, Open-collector output, External use condition: 24 VDC maximum, 10 mA maximum
	Excitation Timing Signal	The signal is output every time the excitation sequence returns to the initial stage "0." (Photocoupler: ON) Example) 0.72°/step (1 Resolution): Signal is output every 10 pulses. 0.072°/step (10 Resolution): Signal is output every 100 pulses.
Functions		Automatic current cutback, Step angle switch, Pulse input mode switch, Smooth drive, All windings off, Excitation timing
Cooling Method		Natural ventilation

## General Specifications

Specifications		Motor	Driver
Insulation Class		Class B (130°C) [Recognized as class A (105°C) by UL Standard]	—
Insulation Resistance		100 MΩ or more when 500 VDC megger is applied between the windings and the case under normal ambient temperature and humidity.	—
Dielectric Strength		Sufficient to withstand 1.5 kV* at 50 Hz or 60 Hz applied between the windings and the case for 1 minute under normal temperature and humidity. *1.0 kV for <b>CRK54□□</b> 0.5 kV for <b>CRK513P, CRK52□PM, CRK52□P, CRK54□PM, CRK54□P</b>	—
Operating Environment (In Operation)	Ambient Temperature	-10~+50°C (non-freezing): High-resolution type, High-torque type, Standard type, <b>TH, PL, PN</b> geared type 0~+40°C (non-freezing): Harmonic geared type	0~+40°C (non-freezing)
	Ambient Humidity	85% or less (non-condensing)	
	Atmosphere	No corrosive gases, dust, water or oil	
Temperature Rise		Temperature rise of the windings are 80°C or less measured by the resistance change method. (at rated current, at standstill, five phases energized)	—
Stop Position Accuracy*1		±3 arc minutes (±0.05°), <b>CRK513P</b> : ±10 arc minutes (±0.17°) High-resolution type: ±2 arc minutes (±0.034°)	—
Shaft Runout		0.05 T.I.R. (mm)*4	—
Radial Play*2		0.025 mm maximum of 5 N	—
Axial Play*3		0.075 mm maximum of 10 N	—
Concentricity		0.075 T.I.R. (mm)*4	—
Perpendicularity		0.075 T.I.R. (mm)*4	—

\*1 This value is for full step under no load. (The value changes with the size of the load.)

\*2 Radial Play: Displacement in shaft position in the radial direction, when a 5 N load is applied in the vertical direction to the tip of the motor's shaft.

\*3 Axial Play: Displacement in shaft position in the axial direction, when a 10 N load is applied to the motor's shaft in the axial direction.

\*4 T.I.R. (Total Indicator Reading): The total dial gauge reading when the measurement section is rotated one revolution centered on the reference axis center.

## Note:

● Do not measure insulation resistance or perform the dielectric strength test while the motor and driver are connected.

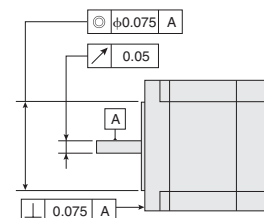

Unit = N

Permissible Overhung Load and Permissible Thrust Load

Type	Model	Permissible Overhung Load Distance from Shaft End (mm)					Permissible Thrust Load
		0	5	10	15	20	
High-Resolution Type High-Torque Type Standard Type	CRK513P□P	12	15	—	—	—	The permissible thrust load shall be no greater than the motor mass.
	CRK523PM□P CRK524PM□P CRK525PM□P CRK523P□P CRK525P□P	25	34	52	—	—	
	CRK544PM□P CRK546PM□P CRK544P□P CRK546P□P CRK543□P CRK544□P CRK545□P	20	25	34	52	—	
	CRK564PM□P CRK566PM□P CRK569PM□P	90	100	130	180	270	
	CRK564□P CRK566□P CRK569□P	63	75	95	130	190	
TH Geared Type	CRK523P□P-T7.2 CRK523P□P-T10 CRK523P□P-T20 CRK523P□P-T30	15	17	20	23	—	10
	CRK543□P-T3.6 CRK543□P-T7.2 CRK543□P-T10 CRK543□P-T20 CRK543□P-T30	10	14	20	30	—	15
	CRK564□P-T3.6 CRK564□P-T7.2 CRK564□P-T10 CRK564□P-T20 CRK564□P-T30	70	80	100	120	150	40
PL Geared Type	CRK545□P-P5 CRK545□P-P7.2 CRK545□P-P10	73	84	100	123	—	50
	CRK543□P-P25 CRK543□P-P36 CRK543□P-P50	109	127	150	184	—	50
	CRK566□P-P5	200	220	250	280	320	100
	CRK566□P-P7.2 CRK566□P-P10	250	270	300	340	390	100
	CRK564□P-P25 CRK564□P-P36 CRK564□P-P50	330	360	400	450	520	100
PN Geared Type	CRK523P□P-N5 CRK523P□P-N7.2 CRK523P□P-N10	45	60	80	100	—	20
	CRK544□P-N5 CRK544□P-N7.2 CRK544□P-N10	100	120	150	190	—	100
	CRK566□P-N5	200	220	250	280	320	100
	CRK566□P-N7.2 CRK566□P-N10	250	270	300	340	390	100
	CRK564□P-N25 CRK564□P-N36 CRK564□P-N50	330	360	400	450	520	100
Harmonic Geared Type	CRK513P□P-H50 CRK513P□P-H100	50	75	—	—	—	60
	CRK543□P-H50 CRK543□P-H100	180	220	270	360	510	220
	CRK564□P-H50 CRK564□P-H100	320	370	440	550	720	450

● Enter **A** (single shaft) or **B** (double shaft) in the box (□) within the model name.

Introduction

AC Input  
Q5STEP  
AS

DC Input  
Q5STEP  
ASC

AC Input  
5-Phase  
RK

5-Phase  
CRK

DC Input  
2-Phase  
CMK

2-Phase  
CSK

2-Phase  
Stepping  
Motors

5-Phase  
Stepping  
Motors

Controllers

Accessories

Installation

## Dimensions (Unit = mm)

### ● Motor

#### ◇ High-Torque Type

##### 1 □ 20 mm

Model	Motor Model	Mass (kg)
<b>CRK513PAP</b>	PK513PA	0.05
<b>CRK513BPB</b>	PK513PB	

Each package model comes with a motor lead wire/connector assembly (0.6 m) (UL Style 3265, AWG24).

If you are purchasing only a motor for maintenance purpose, etc., motor lead wire/connector assembly and connector will not be supplied. They must be purchased separately.

→ Page C-255

#### ● Applicable Connector

Connector housing: 51065-0500 (MOLEX)

Contact: 50212-8100 (MOLEX)

Crimp tool: 57176-5000 (MOLEX)

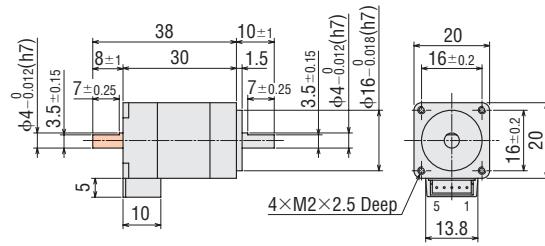

#### ◇ High-Resolution Type, High-Torque Type

##### 2 □ 28 mm

Model	Motor Model	L1	L2	Mass (kg)
<b>CRK523P□AP</b>	PK523P□A	32	—	0.11
<b>CRK523P□BP</b>	PK523P□B		42	
<b>CRK524PMAP</b>	PK524PMA	40	—	0.15
<b>CRK524PMBP</b>	PK524PMB		50	
<b>CRK525P□AP</b>	PK525P□A	51.5	—	0.2
<b>CRK525P□BP</b>	PK525P□B		61.5	

● Enter **M** in the box (□) within the model name in the case of high-resolution type.

Each package model comes with a motor leadwire/connector assembly (0.6 m) (UL Style 3265, AWG24).

If you are purchasing only a motor for maintenance purpose, etc., motor lead wire/connector assembly and connector will not be supplied. They must be purchased separately.

→ Page C-255

#### ● Applicable Connector

Connector housing: 51065-0500 (MOLEX)

Contact: 50212-8100 (MOLEX)

Crimp tool: 57176-5000 (MOLEX)

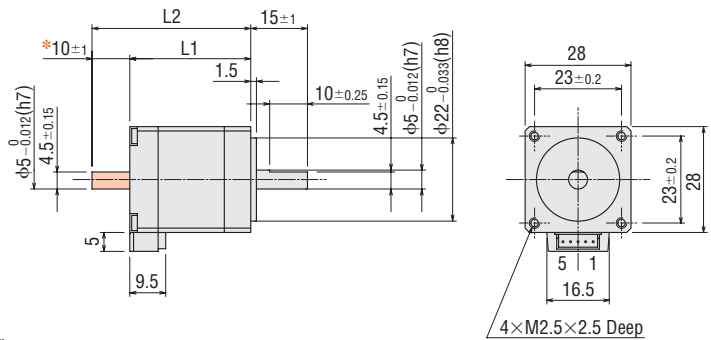

\*The length of machining on double shaft model is 10±0.25.

##### 3 □ 42 mm

Model	Motor Model	L1	L2	Mass (kg)
<b>CRK544P□AP</b>	PK544P□A	39	—	0.3
<b>CRK544P□BP</b>	PK544P□B		54	
<b>CRK546P□AP</b>	PK546P□A	59	—	0.5
<b>CRK546P□BP</b>	PK546P□B		74	

● Enter **M** in the box (□) within the model name in the case of high-resolution Type.

Each package model comes with a motor lead wire/connector assembly (0.6 m) (UL Style 3265, AWG22).

If you are purchasing only a motor for maintenance purpose, etc., motor lead wire/connector assembly and connector will not be supplied. They must be purchased separately.

→ Page C-255

#### ● Applicable Connector

Connector housing: 51103-0500 (MOLEX)

Contact: 50351-8100 (MOLEX)

Crimp tool: 57295-5000 (MOLEX)

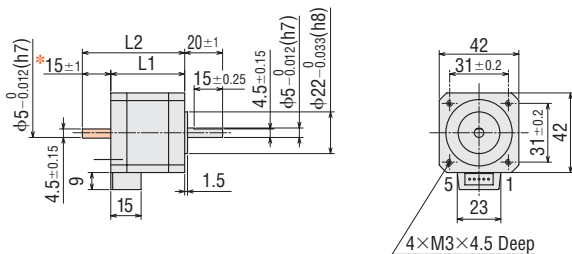

\*The length of machining on double shaft model is 15±0.25.

#### ◇ High-Resolution Type

##### 4 □ 60 mm

Model	Motor Model	L1	L2	L3	φD	Mass (kg)
<b>CRK564PMAP</b>	PK564PMA	46.5	—	7.5±0.15	8 <sup>0</sup> <sub>-0.015</sub>	0.65
<b>CRK564PMBP</b>	PK564PMB		69.5			
<b>CRK566PMAP</b>	PK566PMA	56	—	9.5±0.15	10 <sup>0</sup> <sub>-0.015</sub>	0.87
<b>CRK566PMBP</b>	PK566PMB		79			
<b>CRK569PMAP</b>	PK569PMA	87	—	110	10 <sup>0</sup> <sub>-0.015</sub>	1.5
<b>CRK569PMBP</b>	PK569PMB		110			

Each package model comes with a motor lead wire/connector assembly (0.6 m) (UL Style 3266, AWG22).

If you are purchasing only a motor for maintenance purpose, etc., motor lead wire/connector assembly and connector will not be supplied. They must be purchased separately.

→ Page C-255

#### ● Applicable Connector

Connector housing: 51144-0500 (MOLEX)

Contact: 50539-8100 (MOLEX)

Crimp tool: 57189-5000 (MOLEX)

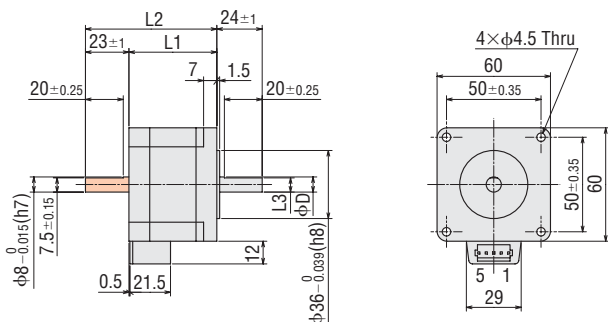

● These dimensions are for double shaft models. For single shaft models, ignore the orange (■) areas.

◇ Standard Type

5 □ 42 mm

Model	Motor Model	L1	L2	Mass (kg)
<b>CRK543AP</b>	PK543NAW	33	-	0.21
<b>CRK543BP</b>	PK543NBW		48	
<b>CRK544AP</b>	PK544NAW	39	-	0.27
<b>CRK544BP</b>	PK544NBW		54	
<b>CRK545AP</b>	PK545NAW	47	-	0.35
<b>CRK545BP</b>	PK545NBW		62	

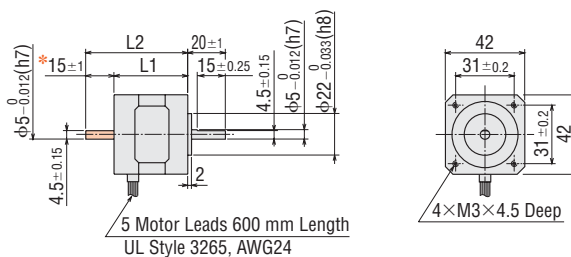

\*The length of machining on double shaft model is 15±0.25.

6 □ 60 mm

Model	Motor Model	L1	L2	Mass (kg)
<b>CRK564AP</b>	PK564NAW	46.5	-	0.6
<b>CRK564BP</b>	PK564NBW		69.5	
<b>CRK566AP</b>	PK566NAW	57.5	-	0.8
<b>CRK566BP</b>	PK566NBW		80.5	
<b>CRK569AP</b>	PK569NAW	87	-	1.3
<b>CRK569BP</b>	PK569NBW		110	

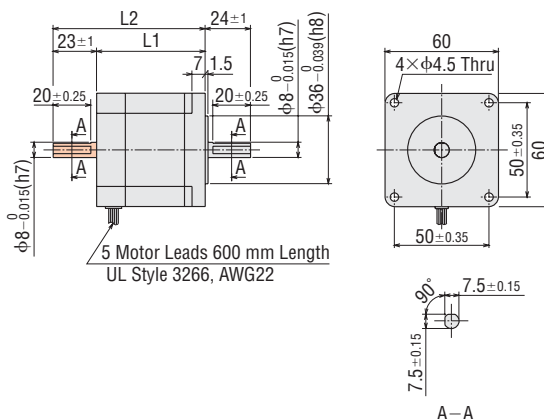

◇ TH Geared Type

7 □ 28 mm

Model	Motor Model	Gear Ratio	Mass (kg)
<b>CRK523PAP-T</b> □	PK523PA-T □	<b>7.2, 10, 20, 30</b>	0.17
<b>CRK523PBP-T</b> □	PK523PB-T □		

● Enter the gear ratio in the box (□) within the model name.  
 Each package model comes with a motor lead wire/connector assembly (0.6 m) (UL Style 3265, AWG24).  
 If you are purchasing only a motor for maintenance purpose, etc., motor lead wire/connector assembly and connector will not be supplied. They must be purchased separately.  
 → Page C-255

● Applicable Connector  
 Connector housing: 51065-0500 (MOLEX)  
 Contact: 50212-8100 (MOLEX)  
 Crimp tool: 57176-5000 (MOLEX)

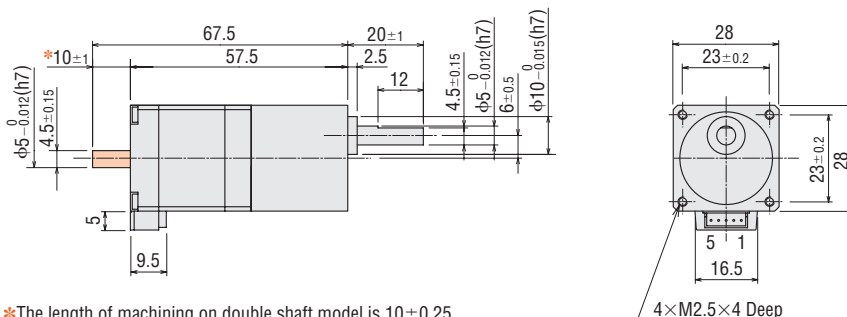

\*The length of machining on double shaft model is 10±0.25.

8 □ 42 mm

Model	Motor Model	Gear Ratio	Mass (kg)
<b>CRK543AP-T</b> □	PK543AW-T □	<b>3.6, 7.2, 10, 20, 30</b>	0.35
<b>CRK543BP-T</b> □	PK543BW-T □		

● Enter the gear ratio in the box (□) within the model name.

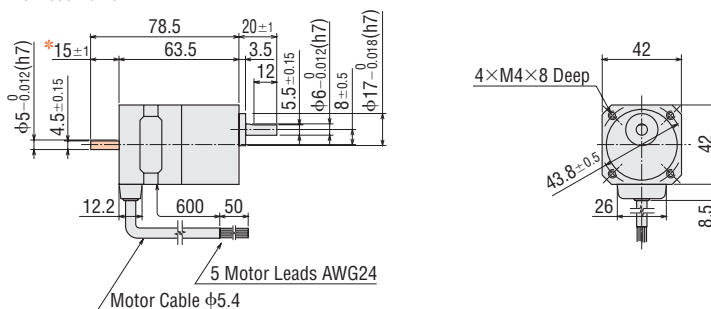

\*The length of machining on double shaft model is 15±0.25.

● These dimensions are for double shaft models. For single shaft models, ignore the orange (■) areas.

## ◇ TH Geared Type

9 □ 60 mm

Model	Motor Model	Gear Ratio	Mass (kg)
<b>CRK564AP-T</b> □	PK564AW-T □	<b>3.6, 7.2, 10, 20, 30</b>	0.95
<b>CRK564BP-T</b> □	PK564BW-T □		

● Enter the gear ratio in the box (□) within the model name.

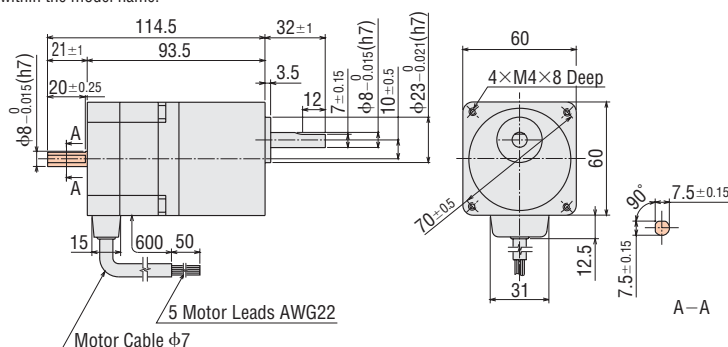

## ◇ PL Geared Type

10 □ 42 mm

Model	Motor Model	Gear Ratio	L1	L2	Mass (kg)
<b>CRK545AP-P</b> □	PK545AW-P □	<b>5, 7.2, 10</b>	74.5	—	0.58
<b>CRK545BP-P</b> □	PK545BW-P □			89.5	
<b>CRK543AP-P</b> □	PK543AW-P □	<b>25, 36, 50</b>	84	—	0.55
<b>CRK543BP-P</b> □	PK543BW-P □			99	

● Enter the gear ratio in the box (□) within the model name.

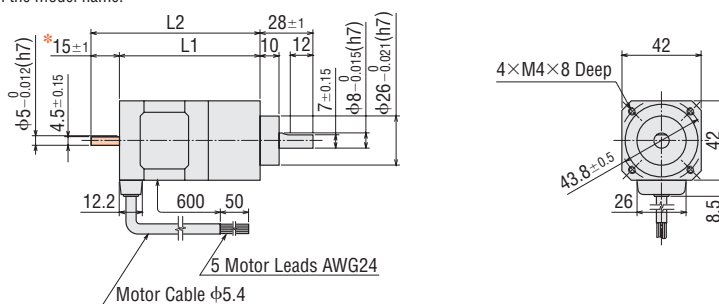

\*The length of machining on double shaft model is 15±0.25.

11 □ 60 mm

Model	Motor Model	Gear Ratio	L1	L2	Mass (kg)
<b>CRK566AP-P</b> □	PK566AW-P □	<b>5, 7.2, 10</b>	94.5	—	1.3
<b>CRK566BP-P</b> □	PK566BW-P □			115.5	
<b>CRK564AP-P</b> □	PK564AW-P □	<b>25, 36, 50</b>	108.5	—	1.4
<b>CRK564BP-P</b> □	PK564BW-P □			129.5	

● Enter the gear ratio in the box (□) within the model name.

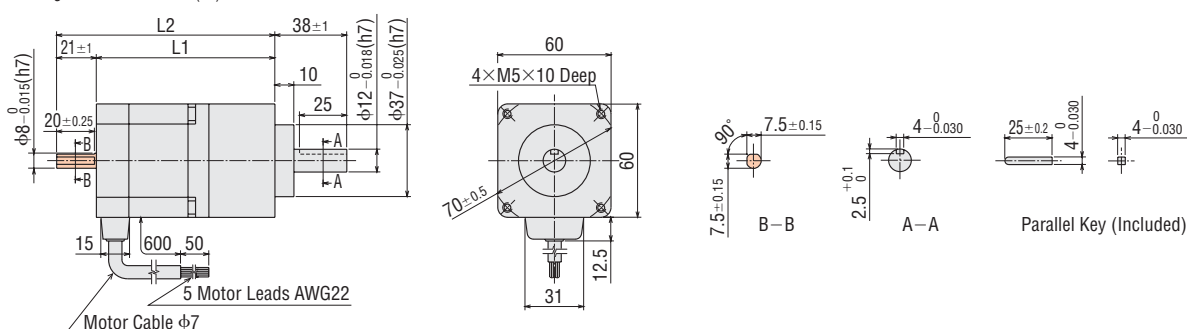

● These dimensions are for double shaft models. For single shaft models, ignore the orange (■) areas.

## ◇ PN Geared Type

12 □ 28 mm

Model	Motor Model	Gear Ratio	Mass (kg)
<b>CRK523PAP-N</b> □	PK523PA-N □	<b>5, 7.2, 10</b>	0.25
<b>CRK523PBP-N</b> □	PK523PB-N □		

● Enter the gear ratio in the box (□) within the model name.

Each package model comes with a motor lead wire/connector assembly (0.6 m) (UL Style 3265, AWG24).

If you are purchasing only a motor for maintenance purpose, etc., motor lead wire/connector assembly and connector will not be supplied. They must be purchased separately.

→ Page C-255

● Applicable Connector

Connector housing: 51065-0500 (MOLEX)

Contact: 50212-8100 (MOLEX)

Crimp tool: 57176-5000 (MOLEX)

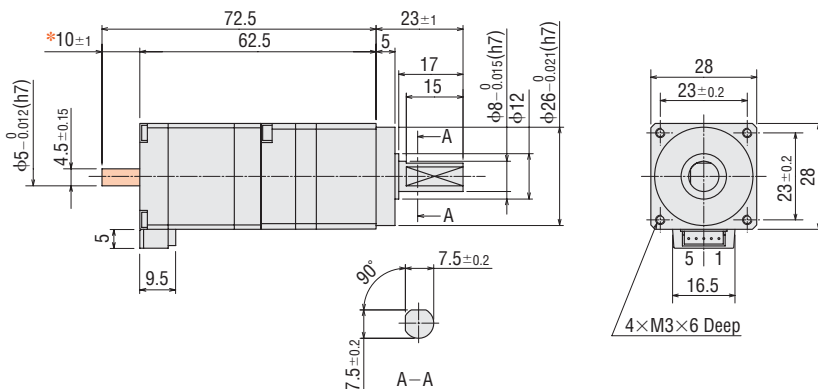

\*The length of machining on double shaft model is 10±0.25.

13 □ 42 mm

Model	Motor Model	Gear Ratio	Mass (kg)
<b>CRK544AP-N</b> □	PK544AW-N □	<b>5, 7.2, 10</b>	0.56
<b>CRK544BP-N</b> □	PK544BW-N □		

● Enter the gear ratio in the box (□) within the model name.

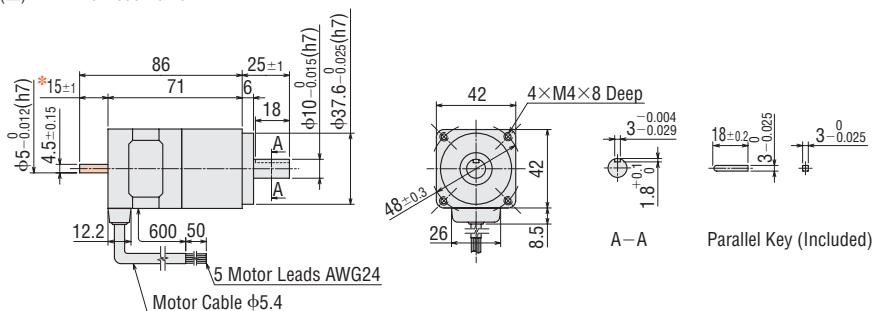

\*The length of machining on double shaft model is 15±0.25.

14 □ 60 mm

Model	Motor Model	Gear Ratio	L1	L2	Mass (kg)
<b>CRK566AP-N</b> □	PK566AW-N □	<b>5, 7.2, 10</b>	103.5	—	1.5
<b>CRK566BP-N</b> □	PK566BW-N □			124.5	
<b>CRK564AP-N</b> □	PK564AW-N □	<b>25, 36, 50</b>	108.5	—	1.5
<b>CRK564BP-N</b> □	PK564BW-N □			129.5	

● Enter the gear ratio in the box (□) within the model name.

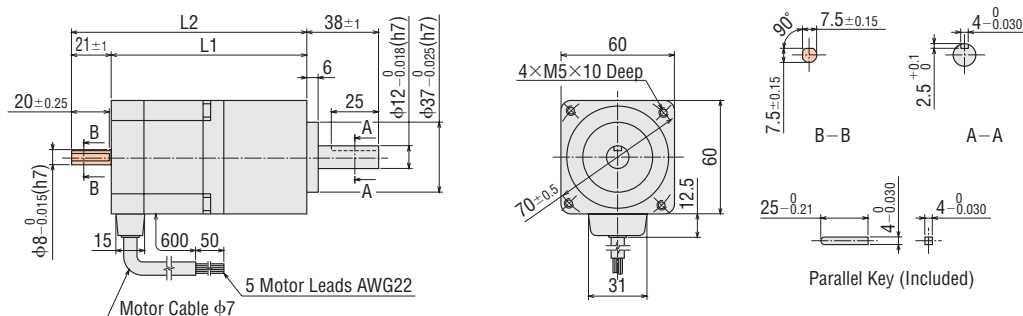

● These dimensions are for double shaft models. For single shaft models, ignore the orange (■) areas.

Introduction

AC Input

DC Input

AC Input

DC Input

DC Input

DC Input

Stepping Motors

Stepping Motors

Controllers

Accessories

Installation



## ◇ Harmonic Geared Type

15 □ 20 mm

Model	Motor Model	Gear Ratio	Mass (kg)
<b>CRK513PAP-H</b> □	PK513PA-H □ S	<b>50, 100</b>	0.08
<b>CRK513BPB-H</b> □	PK513PB-H □ S		

● Enter the gear ratio in the box (□) within the model name.

Each package model comes with a motor lead wire/connector assembly (0.6 m) (UL Style 3265, AWG24).

If you are purchasing only a motor for maintenance purpose, etc., motor lead wire/connector assembly and connector will not be supplied. They must be purchased separately.

→ Page C-255

## ● Applicable Connector

Connector housing: 51065-0500 (MOLEX)

Contact: 50212-8100 (MOLEX)

Crimp tool: 57176-5000 (MOLEX)

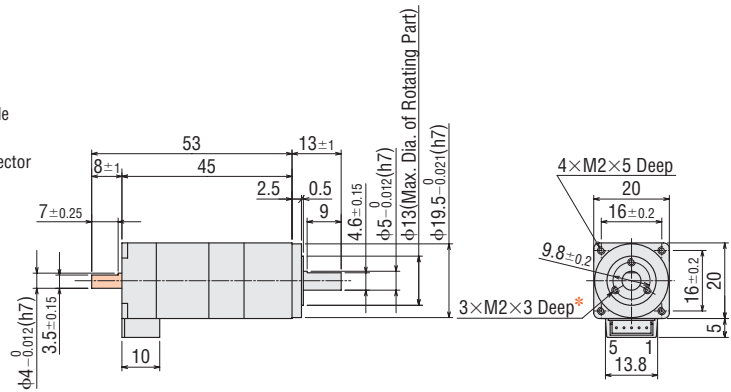

\*The position of the output shaft relative to the screw holes on the rotating part is arbitrary.

16 □ 42 mm

Model	Motor Model	Gear Ratio	Mass (kg)
<b>CRK543AP-H</b> □	PK543AW-H □ S	<b>50, 100</b>	0.46
<b>CRK543BPB-H</b> □	PK543BW-H □ S		

● Enter the gear ratio in the box (□) within the model name.

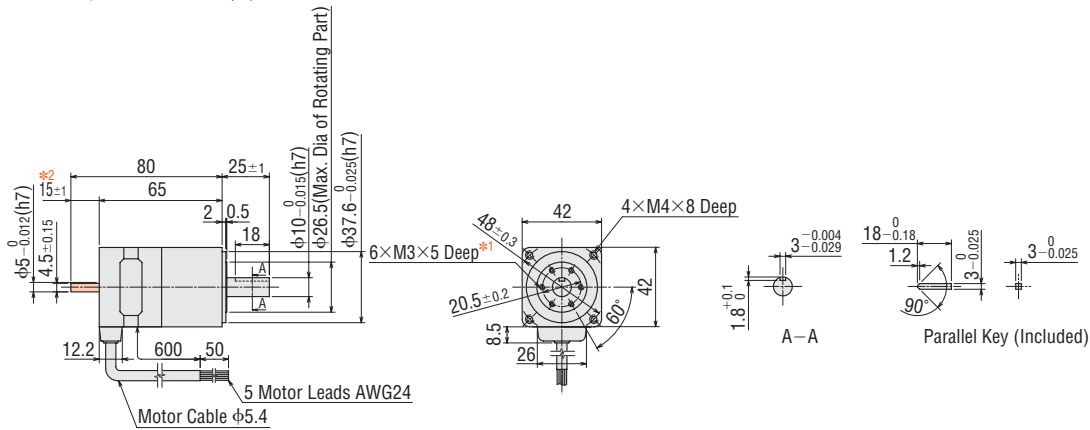

\*1 The position of the output shaft relative to the screw holes position on the rotating part is arbitrary.

\*2 The length of machining on double shaft model is 15±0.25.

17 □ 60 mm

Model	Motor Model	Gear Ratio	Mass (kg)
<b>CRK564AP-H</b> □	PK564AW-H □ S	<b>50, 100</b>	1.08
<b>CRK564BPB-H</b> □	PK564BW-H □ S		

● Enter the gear ratio in the box (□) within the model name.

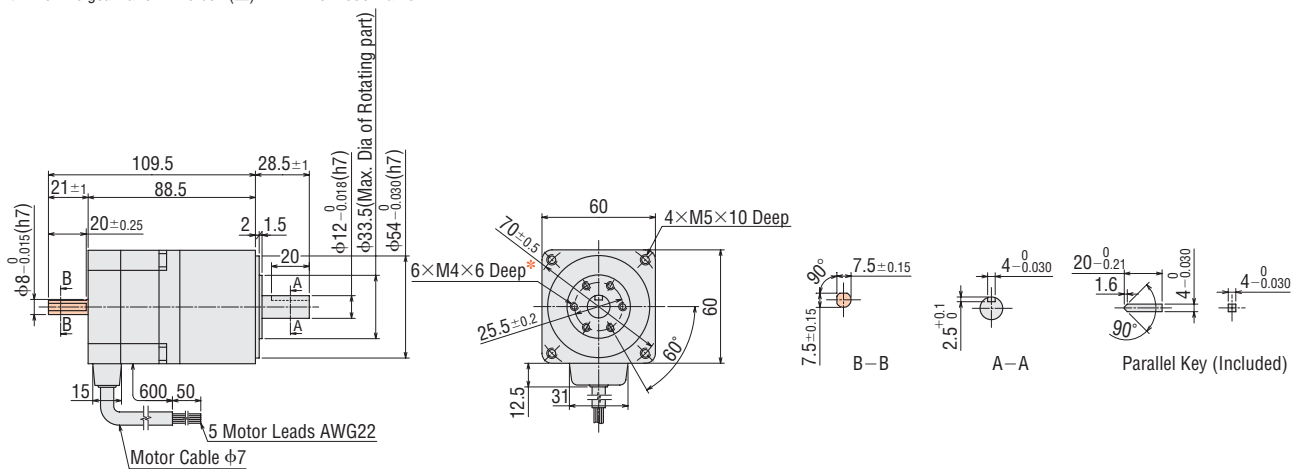

\* The position of the output shaft relative to the screw holes position on the rotating part is arbitrary.

● These dimensions are for double shaft models. For single shaft models, ignore the orange (■) areas.

## ● Driver

18 Driver Model: CRD5103P, CRD5107P, CRD5114P

Mass: 0.04 kg

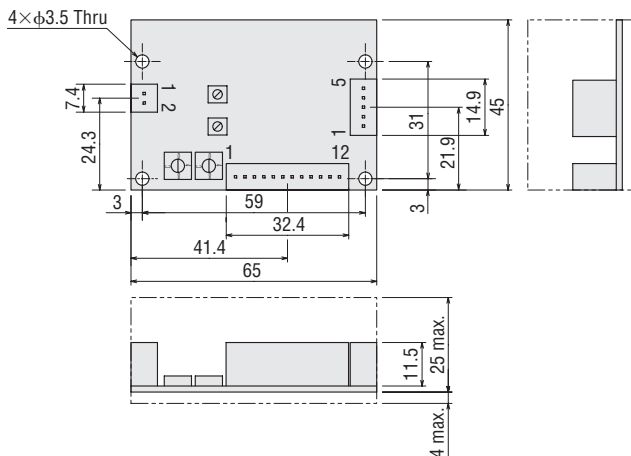

### ● Connector Housing (Included)

- 51103-0200 (MOLEX)
- 51103-1200 (MOLEX)
- 51103-0500 (MOLEX)

### ● Contact (Included)

- 50351-8100 (MOLEX)

### Note:

- Be sure to use the included connector for signal and motor and power supply. When assembling the connectors, use the hand-operated crimp tool [57295-5000 (MOLEX)]. The crimp tool is not provided with the package. It must be purchased separately.

Driver lead wire set crimped with connector (sold separately) is available.

**Driver lead wire set** → Page C-257

Introduction

AC Input  
Q5STEP  
ASDC Input  
Q5STEP  
ASCAC Input  
5-Phase  
RK5-Phase  
CRKDC Input  
2-Phase  
CMK2-Phase  
CSK2-Phase  
Stepping  
Motors5-Phase  
Stepping  
Motors

Controllers

Accessories

Installation

## Connection and Operation

### Names and Functions of Driver Parts

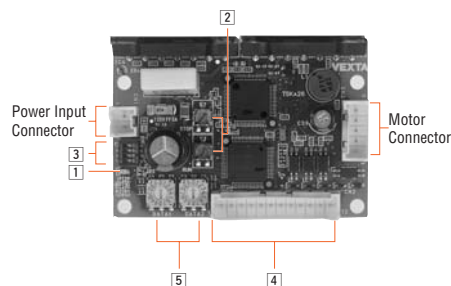

#### 1 Power Input Display

Color	Function	When Activated
Green	Power Supply Indication	Lights when power is on.

#### 2 Current Adjustment Potentiometers

Indication	Name of Potentiometer	Function
RUN	Motor Run Current Potentiometer	For adjusting the motor running current
STOP	Motor Stop Current Potentiometer	For adjusting the motor current at standstill

#### 3 Function Select Switches

Indication	Switch Name	Function
1P/2P	Pulse Input Mode Switch	Switches between 1-pulse input and 2-pulse input.
OFF/SD	Smooth Drive Function Switch	Enables or disables the smooth drive function.
R2/R1	Resolution Select Switch	Switches the base step angle between R1 and R2.

#### 4 Input/Output Signals

Indication	Input/Output	Pin No.	Signal Name	Function
CN2	Input Signal	1	Pulse Signal (CW Pulse Signal)	Operation command pulse signal (The motor will rotate in the CW direction when in 2-pulse input mode.)
		2		
		3	Rotation Direction Signal (CCW Pulse Signal)	Rotation direction signal Photocoupler ON: CW, Photocoupler OFF: CCW. (The motor will rotate in the CCW direction when in 2-pulse input mode.)
		4		
		5	All Windings Off Signal	This signal is used to turn off the output current to the motor so that the motor shaft can be rotated manually.
		6		
		7	Step Angle Select Signal	Switches to step angle set in DATA1 and DATA2.
		8		
		9	Current Cutback Release Signal	This signal is used to disable the automatic current cutback function.
		10		
Output Signal		11	Excitation Timing Signal	The signal is output every time the excitation sequence returns to the initial stage "0."
		12		

#### 5 Step Angle Setting Switch

Indication	Signal Name	Function
DATA1	Step Angle Setting Switch	Each switch can be set to the desired step angle from the 16 step angles.
DATA2		

R1				R2			
DATA1 DATA2	Microstep/ Step 1	Resolution 1	Step Angle 1	DATA1 DATA2	Microstep/ Step 2	Resolution 2	Step Angle 2
0	1	500	0.72°	0	×2.5	200	1.8°
1	2	1000	0.36°	1	×1.25	400	0.9°
2	2.5	1250	0.288°	2	1.6	800	0.45°
3	4	2000	0.18°	3	2	1000	0.36°
4	5	2500	0.144°	4	3.2	1600	0.225°
5	8	4000	0.09°	5	4	2000	0.18°
6	10	5000	0.072°	6	6.4	3200	0.1125°
7	20	10 000	0.036°	7	10	5000	0.072°
8	25	12 500	0.0288°	8	12.8	6400	0.05625°
9	40	20 000	0.018°	9	20	10 000	0.036°
A	50	25 000	0.0144°	A	25.6	12 800	0.028125°
B	80	40 000	0.009°	B	40	20 000	0.018°
C	100	50 000	0.0072°	C	50	25 000	0.0144°
D	125	62 500	0.00576°	D	51.2	25 600	0.0140625°
E	200	100 000	0.0036°	E	100	50 000	0.0072°
F	250	125 000	0.00288°	F	102.4	51 200	0.00703125°

#### Notes:

- The step angle is calculated by dividing the basic step angle by the number of microstep. The above figures are based on a basic step angle of 0.72°.
- With the high-resolution type, the basic step angle and resolution are 0.36° and 1000 (microstep/step: 1), respectively.
- If you are using a geared type, the step angle divided by the gear ratio becomes the actual step angle.
- The number of microstep that can be switched by the C/S (step angle select) signal is limited to those selected in step angles 1 and 2.
- Do not change the C/S signal input or step angle setting switch while the motor is operating. It may cause the motor to misstep and stop.

● Connection Diagrams

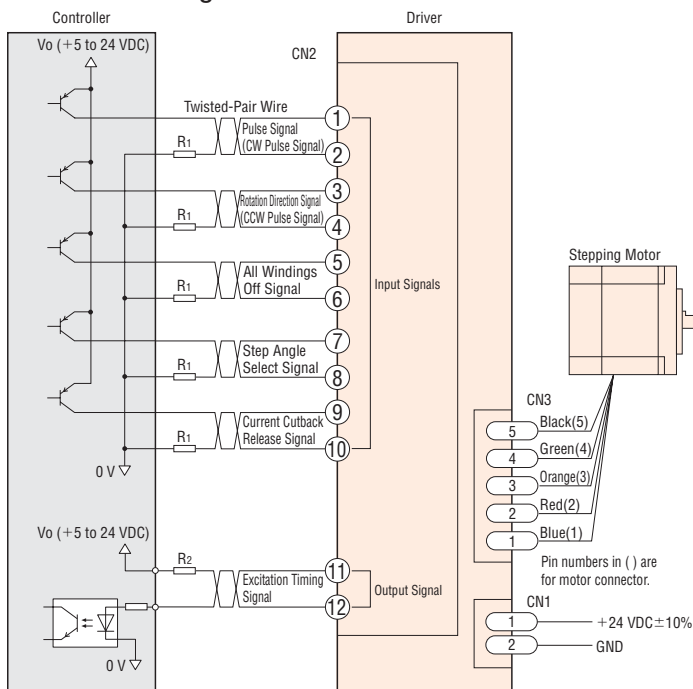

◇ Connecting Input Signal

Keep the input signal voltage to 5 VDC. When the voltage is equal to 5 VDC, the external resistor R<sub>1</sub> is not necessary. When the voltage is above 5 VDC, connect R<sub>1</sub> as shown in the diagram to keep the input current to 20 mA or below. When 5 VDC or more is applied without the external resistor, the internal components may be damaged. Example) If V<sub>o</sub> is 24 VDC, R<sub>1</sub> must be 1.5 to 2.2 kΩ, 0.5 W or more.

◇ Connecting Output Signal

Keep the output signal voltage and current 5 VDC or below and 10 mA or below, respectively. If these specifications are exceeded, the internal components may be damaged. Check the specifications of the connected equipment. When the current is above 10 mA, connect the external resistor R<sub>2</sub> as shown in the diagram to keep it to 10 mA or below.

◇ Power Supply

Use a power supply that can supply sufficient input current. When power supply capacity is insufficient, a decrease in motor output can cause the following malfunctions:  
 ● Motor does not rotate properly at high-speed.  
 ● Slow motor startup and stopping.

◇ Notes on Wiring

- Use twisted-pair wires [AWG24 to 22 (0.2 to 0.3 mm<sup>2</sup>)] with a length of 2 m or less for the signal lines.
- Note that as the length of the pulse signal line increases, the maximum transmission frequency decreases. **Technical reference** → Page F-46
- Use AWG22 (0.3 mm<sup>2</sup>) cables for the power supply lines. When assembling the connectors, use the hand-operated crimp tool for contact or the crimped driver lead wire set cable (sold separately). The crimp tool is not provided with the package. It must be purchased separately.
- Signal lines should be kept at least 2 cm away from power lines (power supply lines and motor lines). Do not bind the signal line and power line together.
- If noise generated by the motor cables or power supply cables causes a problem, try shielding the cables or insert ferrite cores in the cables.
- Incorrect connection of DC power input will lead to driver damage. Make sure that the polarity is correct before turning power on.

● Description of Input/Output Signals

Indication of Input/Output Signal "ON" "OFF"

Input (Output) "ON" indicates that the current is sent into the photocoupler (transistor) inside the driver. Input (Output) "OFF" indicates that the current is not sent into the photocoupler (transistor) inside the driver. The input/output remains "OFF" if nothing is connected.

Photocoupler OFF ON

Pulse (CW) and Rotation Direction (CCW) Input Signal

◇ Input Circuit and Sample Connection

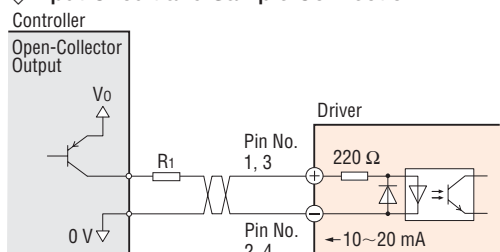

◇ Pulse Waveform Characteristics

● 1-Pulse Input Mode

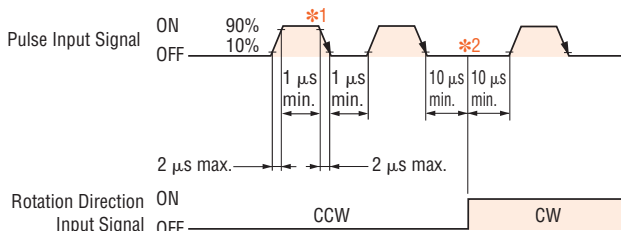

● 2-Pulse Input Mode

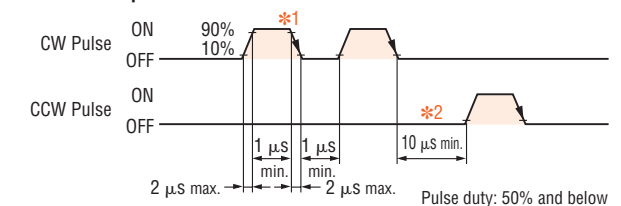

- \*1 The shaded area indicates when the photocoupler diode is ON. The motor moves when the photocoupler state changes from ON to OFF.
- \*2 The minimum interval time when changing rotation direction 10 μs is shown as a response time of circuit. This value varies greatly depending on the motor type and load inertia.

◇ Pulse Signal Characteristics

- Keep the pulse signal at the "photocoupler OFF" state when no pulses are being input.
- In 1-pulse input mode, leave the pulse signal at rest ("photocoupler OFF") when changing rotation directions.
- In 2-pulse input mode, do not input a CW pulse and CCW pulse simultaneously.

All Windings Off (A.W.OFF) Input Signal

Step Angle Select (C/S) Input Signal

Current Cutback Release (C.D.INH) Input Signal

◇ Input Circuit and Sample Connection

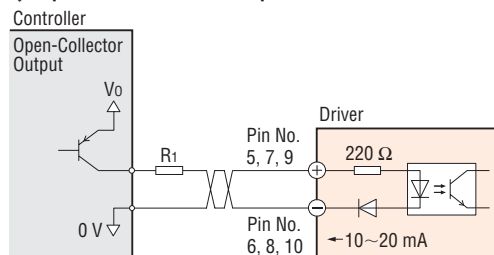

◇ All Windings Off (A.W.OFF) Input Signal

- Inputting this signal puts the motor in a non-excitation (free) state.
- This signal is used to move the motor shaft with external force or perform positioning manually. The photocoupler must be "OFF" when the motor is operating.

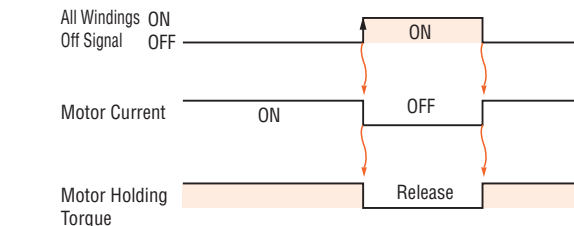

The shaded area indicates that the motor provides holding torque in proportion to standstill current set by STOP switch.

- Switching the "All Windings Off" (A.W.OFF) signal from "photocoupler ON" to "photocoupler OFF" does not alter the excitation sequence. When the motor shaft is manually adjusted with the "A.W.OFF" signal input, the shaft will shift up to ±3.6° (Geared type: ±3.6°/gear ratio) from the position set after the "A.W.OFF" signal is released.

### ◇ Step Angle Select (C/S) Input Signal

- You may select two step angles with the step angle setting switches DATA1 and DATA2.
- When the signal is at "photocoupler OFF," a step angle set by DATA1 is selected; at "photocoupler ON," DATA2 is selected.

Example: Changing the step angle from  $0.072^\circ$  to  $0.72^\circ$ .

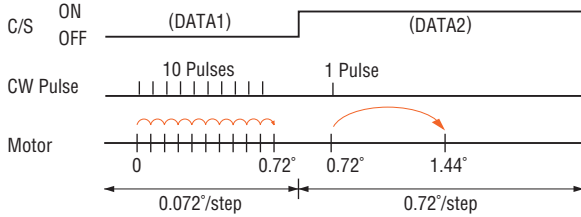

- Be sure to change step angle setting inputs only when the pulse signals are at rest. Switching while moving may cause a positional error of the motor.
- When the "Excitation Timing" signal is used, adjust the number of pulses so that the motor can operate with angles that are multiples of  $7.2^\circ$ . The "Excitation Timing" signal output may become impossible for some combinations of step angles.

Example: After operate 9 pulses with  $0.072^\circ$ /step setting, change the step angle  $0.72^\circ$ /step and operate with 1 pulse. In this case, "Excitation Timing" signal will not be output because step "0" position is skipped.

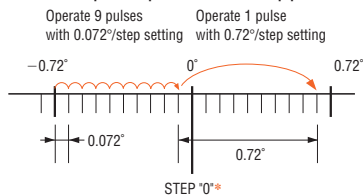

\* "Excitation Timing" signal is only output at step "0" sequence.

### ◇ Current Cutback Release (C.D.INH) Input Signal

- When this signal is in the "photocoupler ON" state, the automatic current cutback function is disabled. When this signal is in the "photocoupler OFF" state, the automatic current cutback function will be activated after the motor stops (after approx. 100 ms).
- The photocoupler must be "OFF" except when the running current is adjusted.

### Excitation Timing (TIMING) Output Signal

#### ◇ Output Circuit and Sample Connection

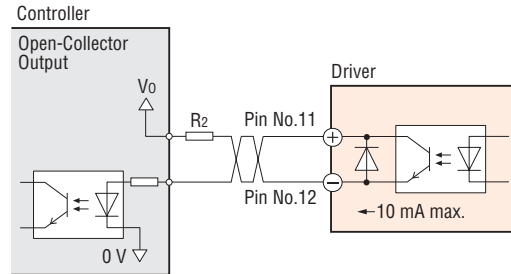

- The "Excitation Timing" signal is output to indicate when the motor excitation (current flowing through the winding) is in the initial stage (step "0" at power up).
- The "Excitation Timing" signal is output simultaneously with a pulse input each time the excitation sequence returns to step "0." The excitation sequence will complete one cycle for every  $7.2^\circ$  rotation of the motor output shaft (basic step angle  $0.72^\circ$ ).  
Microstep/step 1: Signal is output once every 10 pulses.  
Microstep/step 10: Signal is output once every 100 pulses.

#### Timing chart at $0.72^\circ$ /step (microstep/step 1)

\* When connected as shown in the sample connection, the signal will be "photocoupler ON" at step "0."

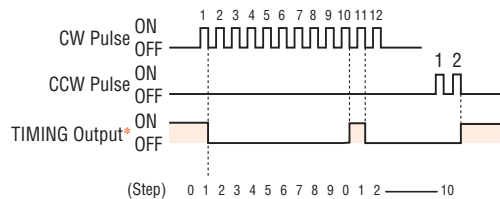

#### Note:

- When power is turned ON, the excitation sequence is reset to step "0" and the "Excitation Timing" signal is output.

### ● Timing Chart

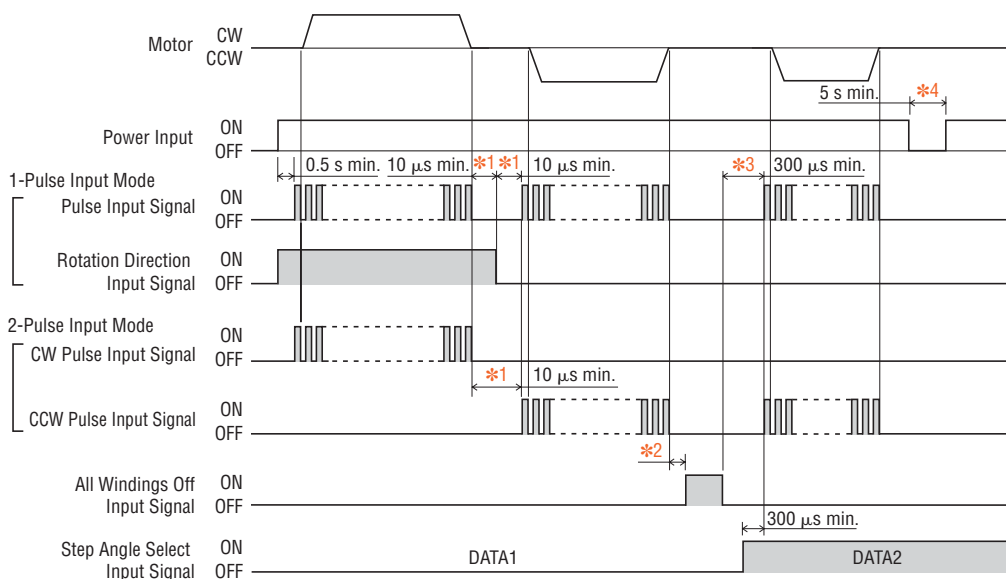

The  section indicates that the photocoupler diode is emitting light.

- \*1 Switching time to change direction (1-pulse input mode), and switching time to change CW, CCW pulse (2-pulse input mode)  $10 \mu\text{s}$  is shown as a response time of circuit. The motor may need more time.
- \*2 Depends on load inertia, load torque, and starting frequency.
- \*3 Never input a pulse signal immediately after switching the "All Windings Off" signal to the "photocoupler OFF" state. The motor may not start.
- \*4 Wait at least 5 seconds before turning on the power again.

## Adjusting the Current

### Adjusting the Motor Current

Use the "RUN" potentiometer to decrease the current and suppress the temperature rise in the motor/driver, or when there is sufficient motor torque and you want to suppress vibration by lowering the current.

Use the "STOP" potentiometer to readjust the current at motor standstill in relation to the holding-brake force of the motor.

Factory settings

Running current: Rated current

Current at motor standstill: Approx. 50% of rated current

Follow the procedure below to adjust the motor current.

### Connecting an Ammeter

Connect a DC ammeter as illustrated below.

Connect a DC ammeter in series to the blue motor lead wire and motor connector pin No. 1. Set all driver input signals to the "photocoupler OFF" state.

Do not connect the red motor lead wire to connector pin No. 2, and black motor lead wire to connector pin No. 5.

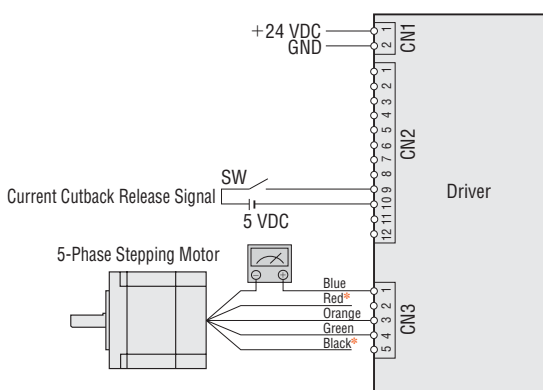

#### Note:

- Do not input pulse signals.
- \* Electric shock may result if the red and black motor lead wires contact each other. Insulate these motor lead wires to prevent electric shock.

### Adjusting the Motor Running Current

To adjust the motor running current, follow the procedure below:

1. Set the current cutback release signal to the "photocoupler ON" state. Keep other signals in the "photocoupler OFF" state.
2. Turn on the power to the driver.
3. Use the "RUN" potentiometer to adjust the motor's running current.
4. When the power is turned on, the value measured by the ammeter represents the total current in two phases through the blue motor lead wire. The current for one phase is equivalent to one-half the ammeter value. (Example: To set the current to 1.0 A/phase, adjust the current level until the ammeter reads 2.0 A.)
5. When the running current has been adjusted, set the current cutback release signal to the "photocoupler OFF" state.

#### Notes:

- Be sure to use the motor at the rated current or below.
- Adjusting the running current will also change the current at standstill.

### Adjusting the Current at Motor Standstill

To adjust the current at motor standstill, follow the procedure below:

1. Set the current cutback release signal to the "photocoupler OFF" state. Keep other signals in the "photocoupler OFF" state.
2. Turn on the power to the driver.
3. Use the "STOP" potentiometer to adjust the motor current at standstill.
4. When the power is turned on, the value measured by the ammeter represents the total current in two phases through the blue motor lead wire. The current for one phase is equivalent to one-half the ammeter value. (Example: To set the current to 1.0 A/phase, adjust the current level until the ammeter reads 2.0 A.)

$$\text{Holding Torque [N}\cdot\text{m]} = \frac{\text{Maximum Holding Torque [N}\cdot\text{m]} \times \text{Current at Standstill [A]}}{\text{Motor Rated Current [A]}}$$

#### Notes:

- Always set the running current first, turn off the driver power and turn it back on, and then set the current at standstill. Setting the running current after current at standstill may change the current setting at standstill.
- Setting the current at motor standstill too low may affect the starting of the motor or the position-holding action.

## List of Motor and Driver Combinations

Model names for motor and driver combinations are shown below.

Type	Model	Motor Model	Driver Model
High-Resolution Type	<b>CRK523PMAP</b> <b>CRK523PMBP</b> <b>CRK524PMAP</b> <b>CRK524PMBP</b> <b>CRK525PMAP</b> <b>CRK525PMBP</b>	PK523PMA* PK523PMB* PK524PMA* PK524PMB* PK525PMA* PK525PMB*	CRD5103P
	<b>CRK544PMAP</b> <b>CRK544PMBP</b> <b>CRK546PMAP</b> <b>CRK546PMBP</b>	PK544PMA* PK544PMB* PK546PMA* PK546PMB*	CRD5107P
	<b>CRK564PMAP</b> <b>CRK564PMBP</b> <b>CRK566PMAP</b> <b>CRK566PMBP</b> <b>CRK569PMAP</b> <b>CRK569PMBP</b>	PK564PMA* PK564PMB* PK566PMA* PK566PMB* PK569PMA* PK569PMB*	CRD5114P
High-Torque Type	<b>CRK513PAP</b> <b>CRK513PBP</b>	PK513PA* PK513PB*	CRD5103P
	<b>CRK523PAP</b> <b>CRK523PBP</b> <b>CRK525PAP</b> <b>CRK525PBP</b>	PK523PA* PK523PB* PK525PA* PK525PB*	
	<b>CRK544PAP</b> <b>CRK544PBP</b> <b>CRK546PAP</b> <b>CRK546PBP</b>	PK544PA* PK544PB* PK546PA* PK546PB*	
Standard Type	<b>CRK543AP</b> <b>CRK543BP</b> <b>CRK544AP</b> <b>CRK544BP</b> <b>CRK545AP</b> <b>CRK545BP</b>	PK543NAW PK543NBW PK544NAW PK544NBW PK545NAW PK545NBW	CRD5107P
	<b>CRK564AP</b> <b>CRK564BP</b> <b>CRK566AP</b> <b>CRK566BP</b> <b>CRK569AP</b> <b>CRK569BP</b>	PK564NAW PK564NBW PK566NAW PK566NBW PK569NAW PK569NBW	CRD5114P
TH Geared Type	<b>CRK523PAP-T7.2</b> <b>CRK523PBP-T7.2</b> <b>CRK523PAP-T10</b> <b>CRK523PBP-T10</b> <b>CRK523PAP-T20</b> <b>CRK523PBP-T20</b> <b>CRK523PAP-T30</b> <b>CRK523PBP-T30</b>	PK523PA-T7.2* PK523PB-T7.2* PK523PA-T10* PK523PB-T10* PK523PA-T20* PK523PB-T20* PK523PA-T30* PK523PB-T30*	CRD5103P
	<b>CRK543AP-T3.6</b> <b>CRK543BP-T3.6</b> <b>CRK543AP-T7.2</b> <b>CRK543BP-T7.2</b> <b>CRK543AP-T10</b> <b>CRK543BP-T10</b> <b>CRK543AP-T20</b> <b>CRK543BP-T20</b> <b>CRK543AP-T30</b> <b>CRK543BP-T30</b>	PK543AW-T3.6 PK543BW-T3.6 PK543AW-T7.2 PK543BW-T7.2 PK543AW-T10 PK543BW-T10 PK543AW-T20 PK543BW-T20 PK543AW-T30 PK543BW-T30	CRD5107P
	<b>CRK564AP-T3.6</b> <b>CRK564BP-T3.6</b> <b>CRK564AP-T7.2</b> <b>CRK564BP-T7.2</b> <b>CRK564AP-T10</b> <b>CRK564BP-T10</b> <b>CRK564AP-T20</b> <b>CRK564BP-T20</b> <b>CRK564AP-T30</b> <b>CRK564BP-T30</b>	PK564AW-T3.6 PK564BW-T3.6 PK564AW-T7.2 PK564BW-T7.2 PK564AW-T10 PK564BW-T10 PK564AW-T20 PK564BW-T20 PK564AW-T30 PK564BW-T30	CRD5114P

Type	Model	Motor Model	Driver Model
PL Geared Type	<b>CRK545AP-P5</b> <b>CRK545BP-P5</b> <b>CRK545AP-P7.2</b> <b>CRK545BP-P7.2</b> <b>CRK545AP-P10</b> <b>CRK545BP-P10</b> <b>CRK543AP-P25</b> <b>CRK543BP-P25</b> <b>CRK543AP-P36</b> <b>CRK543BP-P36</b> <b>CRK543AP-P50</b> <b>CRK543BP-P50</b>	PK545AW-P5 PK545BW-P5 PK545AW-P7.2 PK545BW-P7.2 PK545AW-P10 PK545BW-P10 PK543AW-P25 PK543BW-P25 PK543AW-P36 PK543BW-P36 PK543AW-P50 PK543BW-P50	CRD5107P
	<b>CRK566AP-P5</b> <b>CRK566BP-P5</b> <b>CRK566AP-P7.2</b> <b>CRK566BP-P7.2</b> <b>CRK566AP-P10</b> <b>CRK566BP-P10</b> <b>CRK564AP-P25</b> <b>CRK564BP-P25</b> <b>CRK564AP-P36</b> <b>CRK564BP-P36</b> <b>CRK564AP-P50</b> <b>CRK564BP-P50</b>	PK566AW-P5 PK566BW-P5 PK566AW-P7.2 PK566BW-P7.2 PK566AW-P10 PK566BW-P10 PK564AW-P25 PK564BW-P25 PK564AW-P36 PK564BW-P36 PK564AW-P50 PK564BW-P50	CRD5114P
PN Geared Type	<b>CRK523PAP-N5</b> <b>CRK523PBP-N5</b> <b>CRK523PAP-N7.2</b> <b>CRK523PBP-N7.2</b> <b>CRK523PAP-N10</b> <b>CRK523PBP-N10</b>	PK523PA-N5* PK523PB-N5* PK523PA-N7.2* PK523PB-N7.2* PK523PA-N10* PK523PB-N10*	CRD5103P
	<b>CRK544AP-N5</b> <b>CRK544BP-N5</b> <b>CRK544AP-N7.2</b> <b>CRK544BP-N7.2</b> <b>CRK544AP-N10</b> <b>CRK544BP-N10</b>	PK544AW-N5 PK544BW-N5 PK544AW-N7.2 PK544BW-N7.2 PK544AW-N10 PK544BW-N10	CRD5107P
	<b>CRK566AP-N5</b> <b>CRK566BP-N5</b> <b>CRK566AP-N7.2</b> <b>CRK566BP-N7.2</b> <b>CRK566AP-N10</b> <b>CRK566BP-N10</b> <b>CRK564AP-N25</b> <b>CRK564BP-N25</b> <b>CRK564AP-N36</b> <b>CRK564BP-N36</b> <b>CRK564AP-N50</b> <b>CRK564BP-N50</b>	PK566AW-N5 PK566BW-N5 PK566AW-N7.2 PK566BW-N7.2 PK566AW-N10 PK566BW-N10 PK564AW-N25 PK564BW-N25 PK564AW-N36 PK564BW-N36 PK564AW-N50 PK564BW-N50	CRD5114P
	<b>CRK513PAP-H50</b> <b>CRK513PBP-H50</b> <b>CRK513PAP-H100</b> <b>CRK513PBP-H100</b>	PK513PA-H50S* PK513PB-H50S* PK513PA-H100S* PK513PB-H100S*	CRD5103P
Harmonic Geared Type	<b>CRK543AP-H50</b> <b>CRK543BP-H50</b> <b>CRK543AP-H100</b> <b>CRK543BP-H100</b>	PK543AW-H50S PK543BW-H50S PK543AW-H100S PK543BW-H100S	CRD5107P
	<b>CRK564AP-H50</b> <b>CRK564BP-H50</b> <b>CRK564AP-H100</b> <b>CRK564BP-H100</b>	PK564AW-H50S PK564BW-H50S PK564AW-H100S PK564BW-H100S	CRD5114P

\* If you are purchasing only a motor for maintenance purpose, etc., motor lead wire/connector assembly and connector will not be supplied. They must be purchased separately. They are available as accessories.

Motor lead wire/connector assembly, motor connector set → Page C-255