

Speed control, position control and torque limiting work exactly as a servo motor.

- Speed Range 2~4000 r/min
- Speed Regulation $\pm 0.05\%$
- Built-in position function
- 16 position data
- Torque limiting

Ease of use and high reliability realized at an affordable price

- Digital setting and operation
- Alarm function
- Lineup 30~400 W

Benefits of Brushless Motors

Torque increased when gear head is attached

By combining with the parallel shaft gearhead, the torque can be increased easily as an AC motor. It is still slim and compact, even if gears are equipped. Being a combination type with preassembled motor and gear, installation to the equipment is simple and no worries of damaging the shaft.

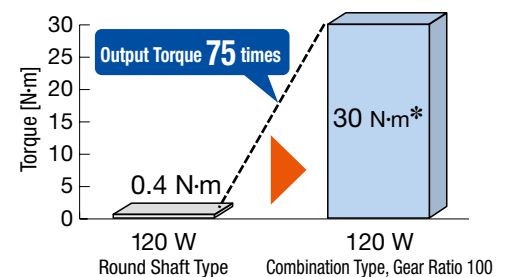

*When motor shaft speed is 2~3000 r/min

● For 120 W motors

Slim and Compact
Even if gears are equipped
Overall Length **141 mm**

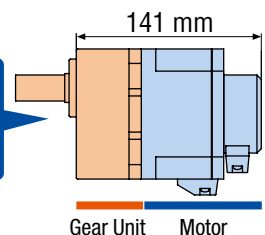

Capable of Driving Large Inertial Loads

Since the motor is constructed to accommodate large rotor inertia, therefore no adjustment is needed even when load inertia is large.

● 200 W, 400 W motor parallel shaft gearhead
Gear ratio 200

Maximum Permissible Load Inertia $37000^* \times 10^{-4} \text{ kg}\cdot\text{m}^2$



* The value changes at instantaneous stop and instantaneous bi-directional operation.

Stable Motor Operation

Flutter characteristics showing the speed fluctuation of the motor*, actual power equivalent to the servo motor.

Effective value: Approx. 0.1%

(Reference value at rated speed)

* Flutter Characteristics

Even if the motor is set to operate at a certain constant speed, the actual speed has little fluctuations against the set speed. The fluctuation in speed is called flutter.

Speed control, position control and torque limiting work exactly as a servo motor.
Improved function and performance achieved at an affordable price.

Speed Control

Highest standard of speed control contributing to improved tact time

Maximum speed 4000 r/min,
Speed ratio 1:2000
(Twice the conventional model)

BXII Series achieves 2~4000 r/min
(For digital setting*) The speed range has been substantially expanded.

*30~4000 r/min for analog setting.

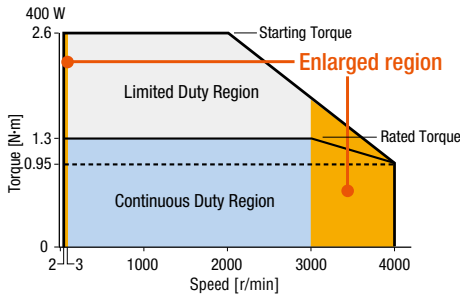

Speed selection according to the load and tact time

Speed can be set in up to 16 different speeds.
(Twice the conventional model)

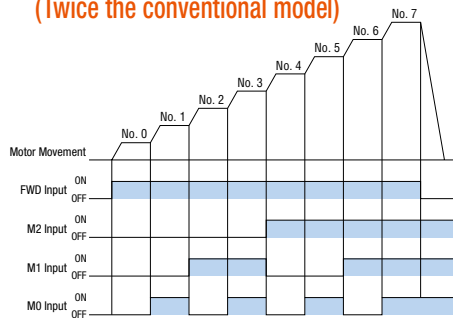

Minimal influence from external environment enabling smooth operations

Speed regulation: $\pm 0.05\%$
(Load, voltage, temperature)

Simple speed control for vertical operation

The electromagnetic brake type motor enables stable speed control during vertical operation (hoisting operation). The electromagnetic brake is automatically controlled via the driver in accordance with ON/OFF of the operation command signal. When the power supply is turned off (or when a power failure occurs), the motor stops instantly to hold the load in place.

- During vertical operation, regenerative energy is produced, therefore a separately-sold regeneration unit is necessary.

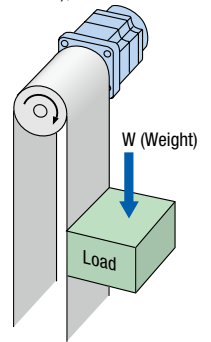

Position Control

With built-in positioning function

Positioning operation is possible using the driver alone. No need for a control module.

Conventional Model
BX Series



BXII Series



Wide variety of positioning operations

- Operating data can be set in up to 16 points (10 points more than the conventional model.)
- There are 3 types of operation functions: independent operation, linked operation, and linked operation 2.

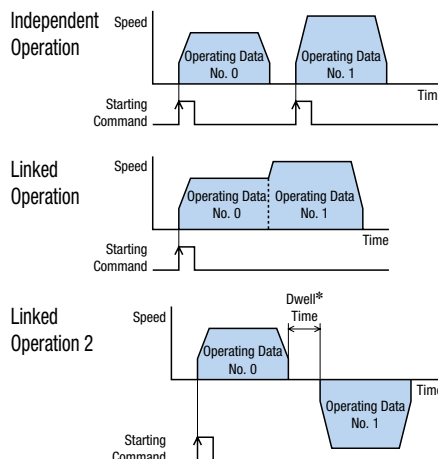

*Dwell time is the waiting time for the next positioning operation to start.

Continuous rotational operation can be in the same direction

If the command position exceeds the "round setting range" parameters, the command position and various rotation data can be returned to 0. Since various rotation data also return to 0, continuous rotational operation in the same direction is possible.

Applications with continuous operation in the same direction

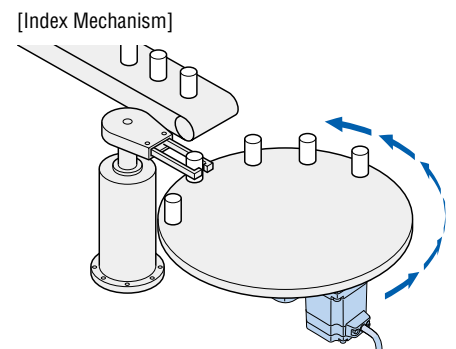

BXII Series



Torque Limiting

What is torque limiting function?

The setting range for the motor maximum torque at 0~250% can be limited in 1% increments. Depending on the conditions, motor torque can be controlled for safety, and the product can be used according to your desired application.

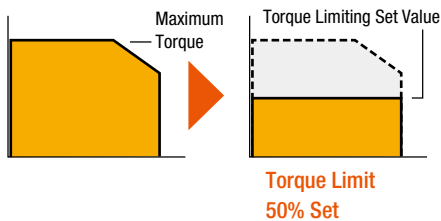

Moreover, with BXII Series...

- Improved torque limiting accuracy
BXII Approx. $\pm 10\%$ (At rated torque)
- Torque Limiting ON/OFF can be switched over via external signals (TL input)

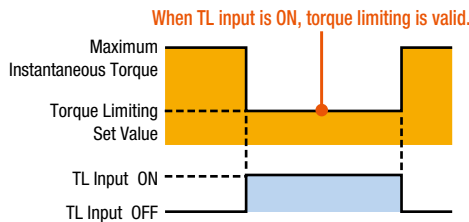

Applications using torque limiting

● Tensioning (Brake)

Used as Brake to Produce Tension

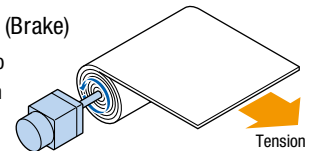

● Pushing

Used for press applications such as for printing

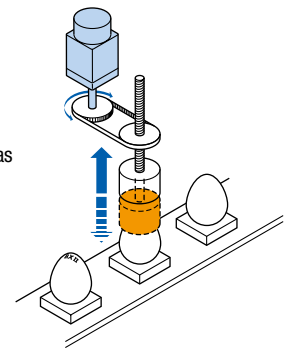

Price

Even with improved functions and performance, the price is similar to conventional models.

Oriental Motor conventional model
BX Series
60 W motor
Combination type,
Parallel-shaft
gearhead
Gear ratio 30



Oriental Motor Conventional Model **BX Series**

BXII Series
60 W motor
Combination type,
Parallel-shaft
gearhead
Gear ratio 30



BXII Series

Digital setting is possible with the driver alone
The functions are also largely improved.

Connection cable not included*



*Also available without connection cables.

● For price and lead time please contact the nearest Oriental Motor office, or visit our website.

New Functions

Teaching Function

Teaching can be done using control module **OPX-2A** (Sold separately) at the driver panel or data setting software **MEXE02***. Move the load to the target position, and the position data can be stored as the positioning data.



Control Module
OPX-2A
(Sold separately)

*You may download the Data Setting Software from website, or send a CD-ROM request to us. For details, please contact the nearest Oriental Motor sales office.

Test Operation Function (JOG operation)

The connection can be confirmed by simply connecting the motor and the driver, and turning the power on.

Return-To-Home Operation

A function where P-PRESET is input at the desired position to confirm the home position. The home position can be set with any value and an external sensor is not required.

With the enhanced of slim and compact driver, digital setting and operation are available. Improvement to user-friendly and reliability performance is now available in full lineup.

User Friendly

Simple Data Setting

Digital setting and operation using the operating panel of the driver. Speed, load factor, current position, operation number and other information are displayed.

The control module **OPX-2A** (Sold separately) can also be used for remote setting.



Indication at a load factor of 50%

With a simple operation of the switch the control mode is changed

Speed control, positioning control,

BX-compatible* (Speed control),

BX-compatible* (Positioning control) can be changed easily.

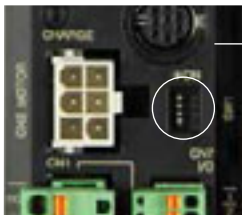

Can be switched over easily

*Usable at almost the same environments as the **BX** Series conventional model

Simple Wiring

● Since the I/O connector has become screwless, welding and special crimp tools are not necessary.

● Motor connectors and encoder connectors can be connected easily.

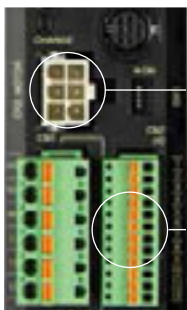

Motor Connector Easy Connection

I/O Connector
Insert the lead wire while pushing the orange button with a screwdriver.

Effective Utilization of Installation Space

With an optimal positioning of the built-in components in the driver, compactness and slimness are achieved. Close contact installation of multiple units, reducing the installation space and enabling more shafts at the same space are available.

Slim and compact driver

Installation area **6400 mm²**

Volume ratio to conventional model
Approx. **5%** decreased



Multiple units are installed in close contact with each other

BXII Series Driver

40 mm



200 mm

Installation width **38%** decrease

Conventional Model **BX** Series Driver

45 mm 25 mm



325 mm

Easy data editing and monitoring

The data setting software (**MEXEO2**) is downloadable from the Oriental Motor website and is also available in CD-ROM (for free). This software is compatible with Windows 7, Vista, XP, 2000, and can perform I/O and speed waveform monitoring, as well as data editing.

● The data setting software can be downloaded from the following URL: <http://www.orientalmotor.eu>

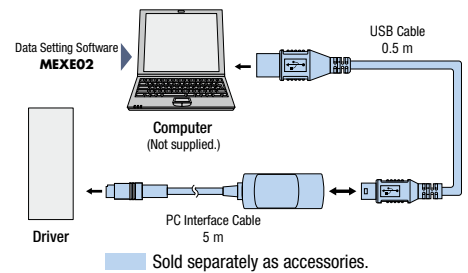

* To connect to a computer, you need to install a dedicated device driver.

Waveform Monitoring

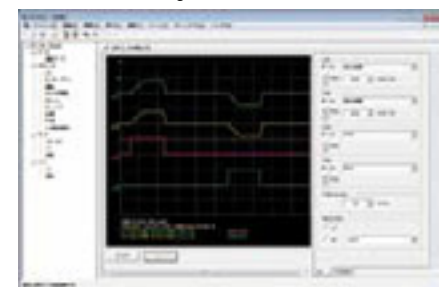

BXII Series



Reliability

Alarm Warning Function

The alarm (protective function) and the warning (warning function) preceding the alarm quickly respond if a problem occurs.

Display Example	Alarm	Warning
· Overflow	10	10
· Overvoltage	22	22
· Overload	30	30



Alarm Code
10 Indication



Warning code
10 Indication

Highly accurate return-to-home

ZSG signals are output for every rotation of the motor. By synchronizing with the external sensor, a more accurate return-to-home is possible.

Sink/Source logic selectable

With the external controller matched, sink/source logic can be changed via the switch in the driver.

Lineup

These products support the voltage specifications used around the world.

- Expanded range of voltage specifications 115 VAC (Conventional model) → 120 VAC, 230 VAC (Conventional model) → 240 VAC
- Single-Phase 200 VAC specification added for 400 W Output Power

Motor Type		Frame Size	Output Power	Package		
				Driver	Power Supply Voltage	Connection Cable
 Round Shaft Type	 Combination Type (Hollow Shaft Flat Gear)	60 mm	30 W		Single-Phase 100-120 VAC Single-Phase 200-240 VAC Three-Phase 200-240 VAC	 Cables for Motor
		80 mm	60 W			
90 mm	120 W					
 Combination Type (Parallel shaft gear)	 Combination Type (Hollow Shaft Flat Gear)	104 mm	200 W			 Cables for Encoder 1 m, 2 m, 3 m or not included
			400 W			

● For each type, models with electromagnetic brakes are also available.

- Extendable up to 30 m by using together with the accessory cable.

Hollow Shaft Flat Gear

High Permissible Torque, Long Life

High permissible torque and long life are achieved through improved gear case rigidity and larger diameters for gears and bearings. A rated life of 10000 hours* is achieved.

* 5000 hours for 200 W and 400 W

Space Saving

Direct connection to the drive shaft is possible without using a connecting part, resulting in space savings for equipment.

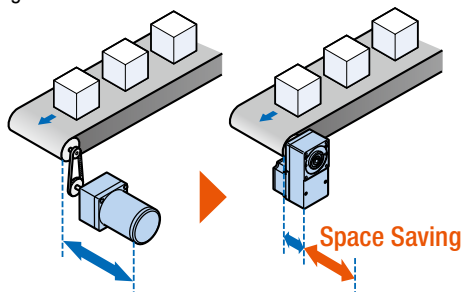

Permissible Torque without Saturation

The hollow shaft flat gearhead enables permissible torque without saturation even at high gear ratios. The motor torque can be fully utilized.

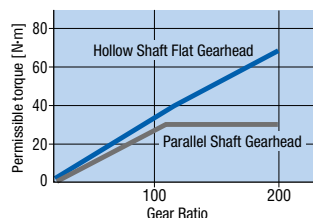

Low Cost

Eliminating parts like the coupling or the belt-and-pulley also decreases parts cost and labor.

