

Modular belts



7870 FT
Page 198

7870 FG
Page 199

7870 DT
Page 200

7870 CT
Page 201

7870 NS
Page 202

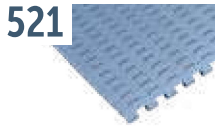

521 FT
Page 214

521 FT One track Belt
Page 215

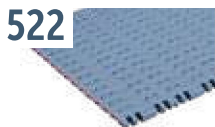

522 HD FT
Page 216

522 HD One track Belt
Page 217

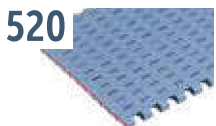

520 FT
Page 204

520 HD FT
Page 205

520 FTT
Page 206

520 FG
Page 207

520 GT
Page 208

520 GT Side indent
Page 209

520 LBP
Page 210

520 PRO LBP
Page 211

520 M
Page 212

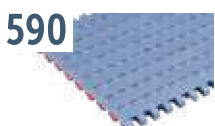

590 FT
Page 219

590 FT One track Belt
Page 220

590 FTT
Page 221

590 FG
Page 222

590 FG One track Belt
Page 223

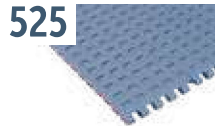

525 HD FT
Page 225

525 HD FT + RIB
Page 226

525 FTT
Page 227

525 HD FG
Page 228

525 HD GT
Page 229

525 HD GT Side indent
Page 230

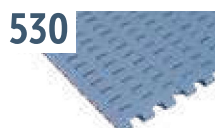

530 FT
Page 232

530 FT One track Belt
Page 233

530 FTT
Page 234

530 GT
Page 235

530 GT Side indent
Page 236

530 LBP
Page 237

530 PRO LBP
Page 238

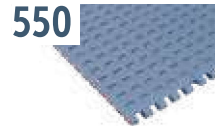

550 FT
Page 240

550 FT One track Belt
Page 241

550 FTT
Page 242

550 UTS & One track Belt
Page 243/244

550 GT
Page 245

550 GT Side indent
Page 246

550 FLIGHT TOP
Page 247/248

550 V & One track Belt
Page 249

550 PRO FT
Page 250

550 PRO M
Page 251



551 FT
Page 253

551 FTT
Page 254

551 GT
Page 255

551 GT Side indent
Page 256

551 LBP
Page 257

551 PRO LBP
Page 258



552 FT
Page 260

552 FT One track Belt
Page 261

552 FTT
Page 262

552 PT
Page 263

552 PT One track Belt
Page 264

552 GT
Page 265

552 GT Side indent
Page 266



553 FLEX TOP
Page 268/269



556 FT
Page 271

556 GT
Page 272

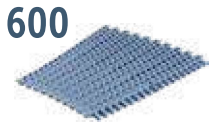
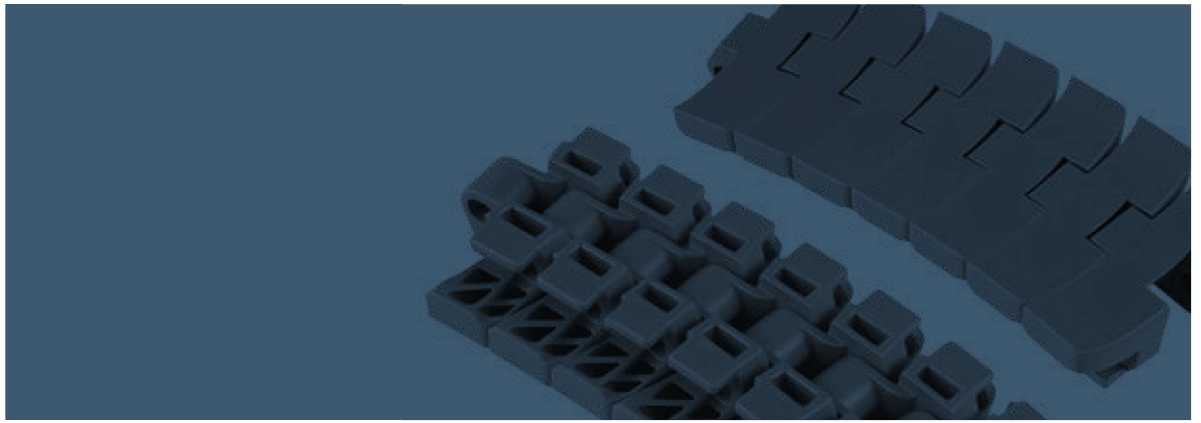

600 Standard
Page 274

600 Heavy duty
Page 275

600 Heavy duty with Bearings Page 276

600 Small radius
Page 277

600 Heavy duty/ Small radius
Page 278

600 Heavy duty/ Small radius with Bearings Page 279

600 with pusher
Page 280

Dedicated molded profiles
Page 281 > 285

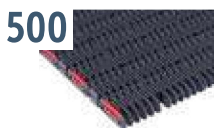

500 RR
Page 284

500 RR with Positioner
Page 285



Comb
Page 286

Comb Quick-link
Page 287

AT-Comb
Page 288



ZERO CONTACT
Page 290/291

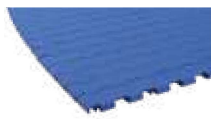

ZERO CONTACT PRO
Page 292/293



240 XE FT
Page 295

240 XE FG
Page 296

240 XE TAB FT
Page 297

240 XE TAB FG
Page 298



260 M FT
Page 299

260 M FG
Page 300

260 TAB
Page 301



261 M FT
Page 302

261 TAB
Page 303

NoseBars Standard

for Modular belt:



7870 Series
Page 307

520 Series
Page 307

525 Series
Page 307

521 Series
Page 308

522 HD Series
Page 308

530 Series
(LBP excluded) Page 309

530 LBP
Page 309

530 PRO LBP
Page 310

NoseBars with Bearings

for Modular belt:



520 Series
Page 311

525 Series
Page 311

521 Series
Page 311

522 HD Series
Page 312

530 Series
(LBP excluded) Page 312

530 LBP
Page 313

530 PRO LBP
Page 313

NoseBars with Rollers

for Modular belt:



520 Series
Page 314

525 Series
Page 314

521 Series
Page 314

522 HD Series
Page 315

530 Series
(LBP excluded) Page 315

One piece

Custom made NoseBar, supplied in a single piece.

Standard

for Modular belt:



520 Series
Page 316

525 Series
Page 316

522 HD Series
Page 316

530 Series
Page 316

with Bearings

for Modular belt:



520 Series
Page 317

525 Series
Page 317

522 HD Series
Page 317

530 Series
Page 317

with Rollers

for Modular belt:



520 Series
Page 318

525 Series
Page 318

522 HD Series
Page 318

530 Series
Page 318

7870 Series

7870

Pitch 8 mm

H= 6 mm

Imperial Size



7870 FT

7870 FG

7870 DT

7870 CT



7870 NS

Movex[®]

7870 FT

Tappeto Modulare 7870 FT, H=6 M=3"
Modular Belt Series 7870 FT, H=6 M=3" / Modulare Mattenkette 7870 FT, H=6 M=3"

Backflex radius min.: 7.5 mm | Pin diameter: 3 mm

	NoseBars
pg. 354	pg. 307
Active transfer plate	
pg. 334>338	pg. 771>781

SAMPLE BOX	
Art.-Nr.	5331018888A



- Easier installation
- Quicker maintenance

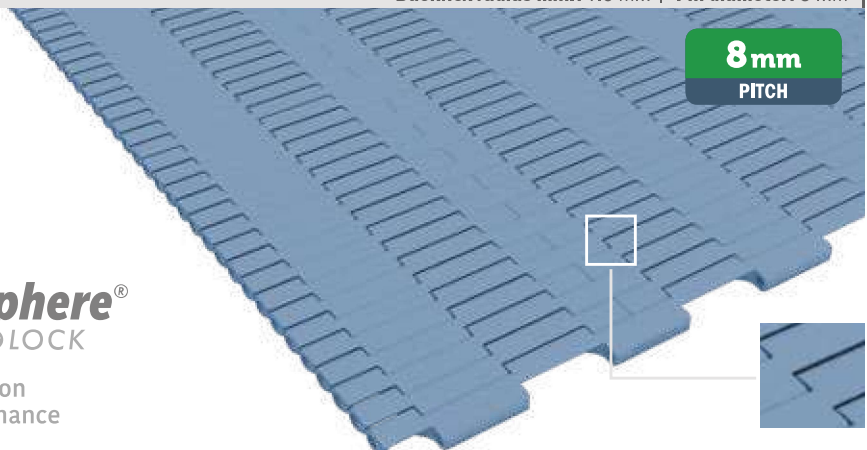

8 mm
PITCH

Width* (inch)
0003
0006
0009
0012
0015
0018
0021
0024
0027
0030
0033
0036
0039
0042
0045
0048
0051
0054

Version A - Standard

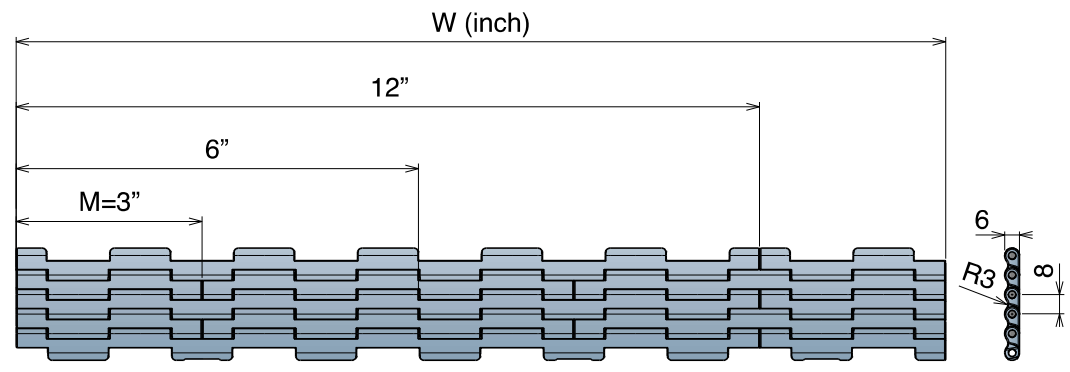

BELT MATERIAL	
POM - Acetal resin	
BELT COLORS	
RAL 5005	Cyan
White	LFA
PINS AVAILABLE	
PBT Pin	
Max w. load:	3000 N/m
Weight:	5.8 kg/m ²
Temp. range:	-40+80 °C



7870 FT
MOVEX TOOL

Developed to facilitate belt assembly and disassembly.



Article Nr. 29969

Movex tools are made with 3D printer, the color may vary due to availability of the material.

***Belts wider than standard are available with 3 inch increments.**

The nominal tensile strength and the nominal width tolerance are valid for a temperature of 23°C (73 °F).



The actual width of the belt typically falls below the nominal value by 0.1% to 0.3%. For POM belts up to 750 mm (30") in width, the shrinkage ranges from -3 mm to 1 mm, and for those wider, from -0.35% to 0%.

Non-Standard belt widths are incremented by 25.4 mm (1"). The minimum width is 50.8 mm (2.0").

NEW 7870 FG

Tappeto Modulare 7870 FG, H=6 M=3"
Modular Belt Series 7870 FG, H=6 M=3" / Modulare Mattenkette 7870 FG, H=6 M=3"

Backflex radius min.: 7.5 mm | Pin diameter: 3 mm

	NoseBars
pg. 354	pg. 307
	Active transfer plate
pg. 334>338	pg. 771>781

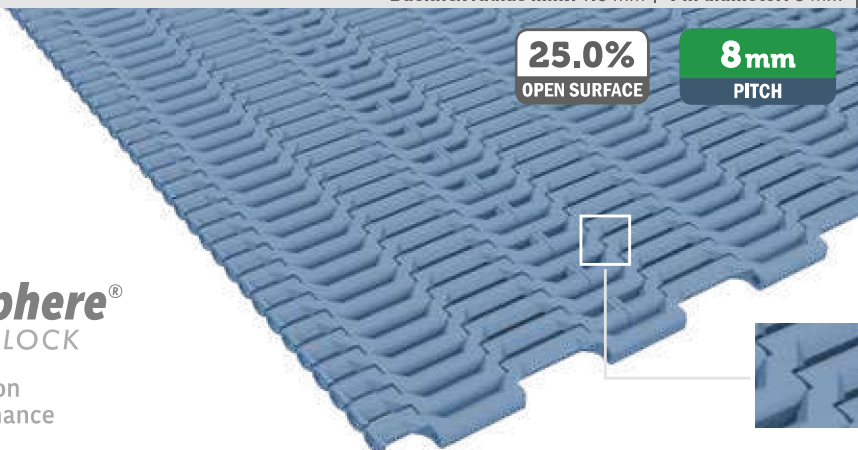

Imperial Size



- Easier installation
- Quicker maintenance

Width* (inch)
0003
0006
0009
0012
0015
0018
0021
0024
0027
0030
0033
0036
0039
0042
0045
0048
0051
0054

Version A - Standard

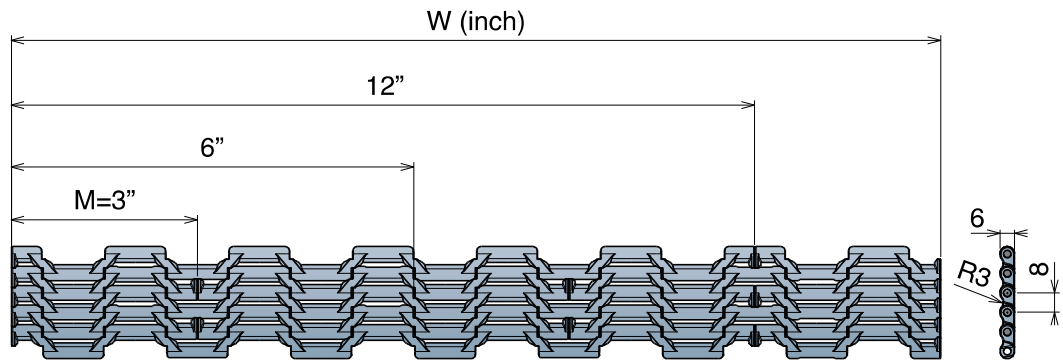

BELT MATERIAL	
POM - Acetal resin	
BELT COLORS	
RAL 5005	Cyan
White	LFA
PINS AVAILABLE	
PBT Pin	
Max w. load:	2900 N/m
Weight:	5.1 kg/m ²
Temp. range:	-40÷80 °C

7870 FT MOVEX TOOL

Developed to facilitate belt assembly and disassembly.



Article Nr. **29969**

Movex tools are made with 3D printer, the color may vary due to availability of the material.

***Belts wider than standard are available with 3 inch increments.**

The nominal tensile strength and the nominal width tolerance are valid for a temperature of 23°C (73 °F).



The actual width of the belt typically falls below the nominal value by 0.1% to 0.3%.

Non-Standard belt widths are incremented by 25.4 mm (1"). The minimum width is 50.8 mm (2.0").

NEW 7870 DT

Tappeto Modulare 7870 DT, H=6 M=3"
Modular Belt Series 7870 DT, H=6 M=3" / Modulare Mattenkette 7870 DT, H=6 M=3"

Backflex radius min.: 7.5 mm | Pin diameter: 3 mm

	NoseBars
pg. 354	pg. 307
Active transfer plate	
pg. 334>338	pg. 771>781

8 mm
PITCH



- Easier installation
- Quicker maintenance

Width* (inch)
0003
0006
0009
0012
0015
0018
0021
0024
0027
0030
0033
0036
0039
0042
0045
0048
0051
0054

Version A - Standard

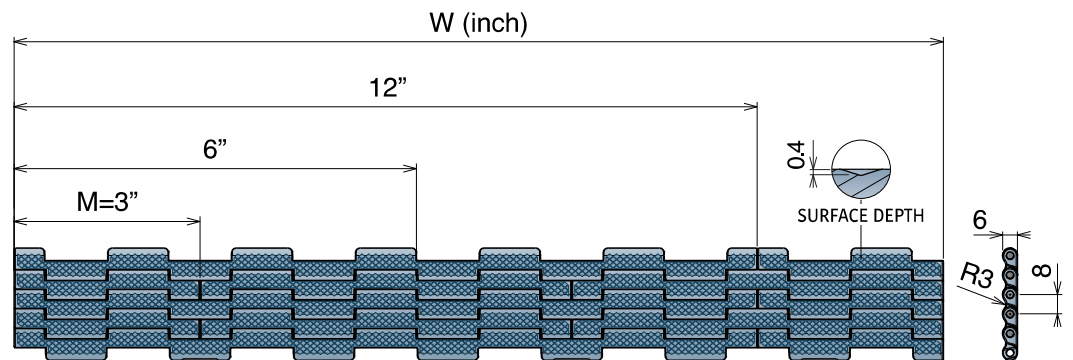

BELT MATERIAL	
POM - Acetal resin	
BELT COLORS	
RAL 5005	Cyan
White	LFA
PINS AVAILABLE	
PBT Pin	
Max w. load:	3000 N/m
Weight:	5.7 kg/m ²
Temp. range:	-40÷80 °C

7870 FT MOVEX TOOL

Developed to facilitate belt assembly and disassembly.



Article Nr. **29969**

Movex tools are made with 3D printer, the color may vary due to availability of the material.

*Belts wider than standard are available with 3 inch increments.

The nominal tensile strength and the nominal width tolerance are valid for a temperature of 23°C (73 °F).



The actual width of the belt typically falls below the nominal value by 0.1% to 0.3%. For POM belts up to 750 mm (30") in width, the shrinkage ranges from -3 mm to 1 mm, and for those wider, from -0.35% to 0%.

Non-Standard belt widths are incremented by 25.4 mm (1"). The minimum width is 50.8 mm (2.0").

NEW 7870 CT

Tappeto Modulare 7870 CT, H=6 M=3"
Modular Belt Series 7870 CT, H=6 M=3" / Modulare Mattenkette 7870 CT, H=6 M=3"

Backflex radius min.: 7.5 mm | Pin diameter: 3 mm

	NoseBars
pg. 354	pg. 307
	Active transfer plate
pg. 334>338	pg. 771>781

	Pin Sphere
pg. 651>661	



- Easier installation
- Quicker maintenance

Width* (inch)
0003
0006
0009
0012
0015
0018
0021
0024
0027
0030
0033
0036
0039
0042
0045
0048
0051
0054

Version A - Standard

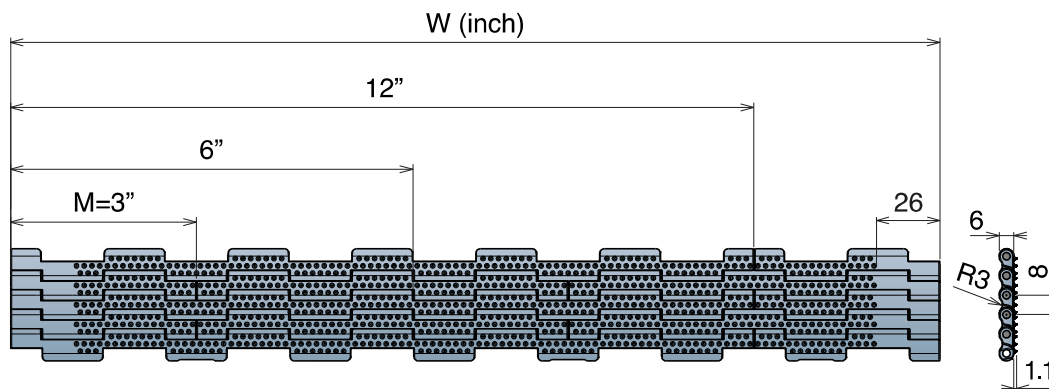

BELT MATERIAL	
POM - Acetal resin	
BELT COLORS	
RAL 5005	Cyan
White	LFA
PINS AVAILABLE	
PBT Pin	
Max w. load:	3000 N/m
Weight:	5.9 kg/m ²
Temp. range:	-40+80 °C

7870 FT MOVEX TOOL

Developed to facilitate belt assembly and disassembly.



Article Nr. **29969**

Movex tools are made with 3D printer, the color may vary due to availability of the material.

*Belts wider than standard are available with 3 inch increments.

The nominal tensile strength and the nominal width tolerance are valid for a temperature of 23°C (73 °F).

The actual width of the belt typically falls below the nominal value by 0.1% to 0.3%.

Non-Standard belt widths are incremented by 25.4 mm (1"). The minimum width is 50.8 mm (2.0").

7870 NS

Tappeti modulari / Modular belts / Mattenketten

PATENTED

Belts wider than standard are available with 3 inch increments (standard) or 1 inch increments (special)



NEW 7870 NS

Tappeto Modulare 7870 NS, H=6 M=3"

Modular Belt Series 7870 NS, H=6 M=3" / Modulare Mattenkette 7870 NS, H=6 M=3"

Backflex radius min.: 7.5 mm | Pin diameter: 3 mm

Imperial Size

	NoseBars
pg. 354	pg. 307
Active transfer plate	
pg. 334>338	pg. 771>781

8 mm
PITCH



- Easier installation
- Quicker maintenance

Width* (inch)

0003

0006

0009

0012

0015

0018

0021

0024

0027

0030

0033

0036

0039

0042

0045

0048

0051

0054

Version A - Standard

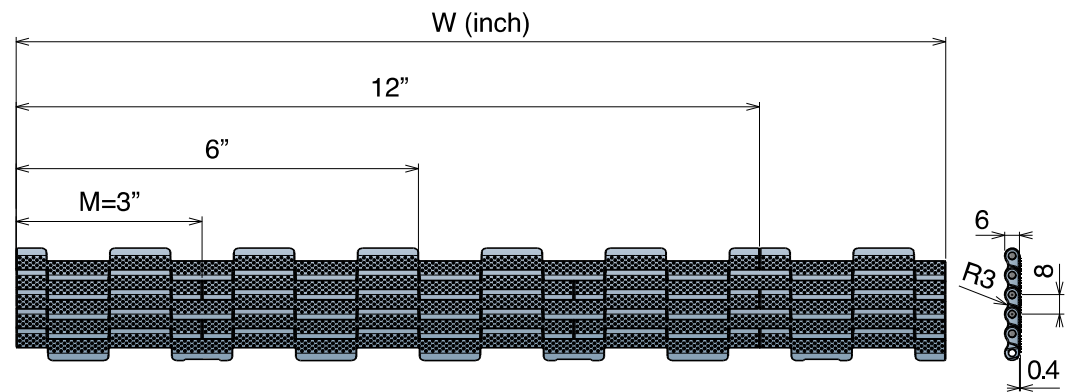

BELT MATERIAL

POM - Acetal resin

BELT COLORS

RAL 5005

Cyan

White

LFA

PINS AVAILABLE

PBT Pin

Max w. load: 3000 N/m

Weight: 5.9 kg/m²

Temp. range: -40÷80 °C

7870 FT
MOVEX TOOL

Developed to facilitate belt assembly and disassembly.



Article Nr. **29969**

Movex tools are made with 3D printer, the color may vary due to availability of the material.

***Belts wider than standard are available with 3 inch increments.**

The nominal tensile strength and the nominal width tolerance are valid for a temperature of 23°C (73 °F).

The actual width of the belt typically falls below the nominal value by 0.1% to 0.3%. For POM belts up to 750 mm (30") in width, the shrinkage ranges from -3 mm to 1 mm, and for those wider, from -0.35% to 0%.

Non-Standard belt widths are incremented by 25.4 mm (1"). The minimum width is 50.8 mm (2.0").

520

Pitch 12,7 mm
H= 8,7 mm



520 FT
520 HD FT
520 FTT
520 FG
520 GT
520 GT *Side Indent*

520 LBP
520 PRO LBP
520 M



520 FT

Tappeto Modulare 520 FT, H=8,7 M=85
Modular Belt Series 520 FT, H=8,7 M=85 / Modulare Mattenkette 520 FT, H=8,7 M=85

CODE STRUCTURE GUIDE (Example)

Backflex radius min.: 10 mm

5201	01	0085	A
Series	*Material	Width	Version

		
pg. 357-358	307/311/314	pg. 771-781

SAMPLE BOX	
Art.-Nr.	5201018888A



REINFORCED POSITIONER

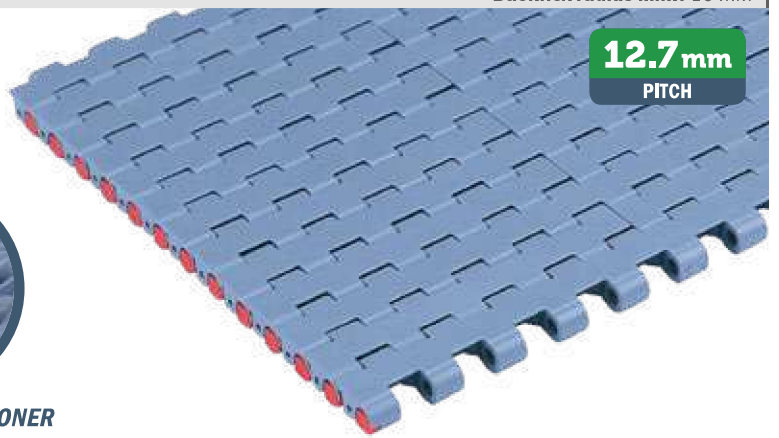

12.7mm
PITCH

* Material

LFA - Code 01

Low friction Acetal

Easy Delivery

Max w. load: 21500 N/m
Weight: 7,8 kg/m²
Temp. range dry: -40+80 °C
Temp. range wet: -40+65 °C
Pin material: PBT white

PP - Code 02

Polypropylene

Max w. load: 13000 N/m
Weight: 7,5 kg/m²
Temp. range dry: 4+104 °C
Temp. range wet: 4+104 °C
Pin material: PP blue

MX - Code 03

Performance PBT

Max w. load: 17500 N/m
Weight: 7,5 kg/m²
Temp. range dry: -40+120 °C
Temp. range wet: -40+60 °C
Pin material: POM grey

LFB - Code 23

Low friction Acetal

Max w. load: 21500 N/m
Weight: 7,8 kg/m²
Temp. range dry: -40+80 °C
Temp. range wet: -40+65 °C
Pin material: PBT white

MPX - Code 25

Lubricated Acetal

Max w. load: 21500 N/m
Weight: 7,8 kg/m²
Temp. range dry: -40+80 °C
Temp. range wet: -40+65 °C
Pin material: PBT white

PFX - Code 30

Extra performance PBT

Max w. load: 17500 N/m
Weight: 7,5 kg/m²
Temp. range dry: -40+120 °C
Temp. range wet: -40+60 °C
Pin material: POM grey

**THE BEST CHOICE FOR
DRY RUNNING APPLICATIONS**

Version A - Standard

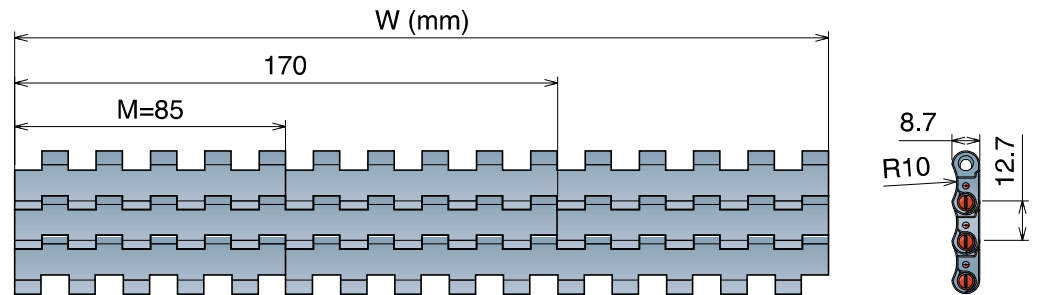

Version B - With 1 Positioner

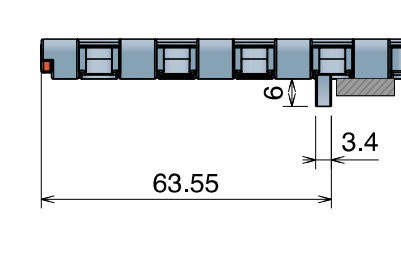

Version C - With 2 Positioner

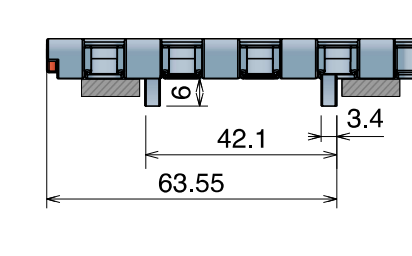

Version A - Standard

Series	Material	Width	Version
5201	*	0085	A
5201	*	0170	A
5201	*	0255	A
5201	*	0340	A
5201	*	0425	A
5201	*	0510	A
5201	*	0595	A
5201	*	0680	A
5201	*	0765	A
5201	*	0850	A
5201	*	0935	A
5201	*	1020	A
5201	*	1105	A
5201	*	1190	A
5201	*	1275	A
5201	*	1360	A
5201	*	1445	A
5201	*	1530	A

Version B - With 1 Positioner

Series	Material	Width	Version
5201	*	0085	B
5201	*	0170	B
5201	*	0255	B
5201	*	0340	B
5201	*	0425	B
5201	*	0510	B
5201	*	0595	B
5201	*	0680	B
5201	*	0765	B
5201	*	0850	B
5201	*	0935	B
5201	*	1020	B
5201	*	1105	B
5201	*	1190	B
5201	*	1275	B
5201	*	1360	B
5201	*	1445	B
5201	*	1530	B

Version C - With 2 Positioners

Series	Material	Width	Version
5201	*	0085	C
5201	*	0170	C
5201	*	0255	C
5201	*	0340	C
5201	*	0425	C
5201	*	0510	C
5201	*	0595	C
5201	*	0680	C
5201	*	0765	C
5201	*	0850	C
5201	*	0935	C
5201	*	1020	C
5201	*	1105	C
5201	*	1190	C
5201	*	1275	C
5201	*	1360	C
5201	*	1445	C
5201	*	1530	C

520 HD FT

Tappeto Modulare 520 HD, H=8,7 M=85
Modular Belt Series 520 HD, H=8,7 M=85 / Modulare Mattenkette 520 HD, H=8,7 M=85

Metric Size

CODE STRUCTURE GUIDE (Example)

Backflex radius min.: 10 mm

5211	01	0085	A
Series	*Material	Width	Version

12.7mm
PITCH

pg. 355-356	307/311/314	pg. 771>781

SAMPLE BOX	
Art.-Nr.	5211018388A

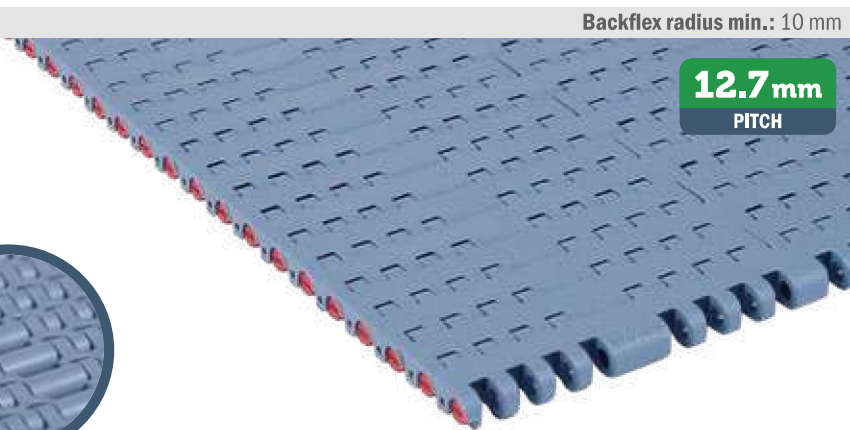
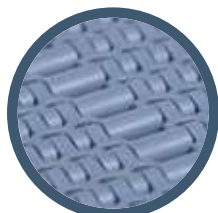

*Material

LFA - Code 01

Low friction Acetal

Easy Delivery

Max w. load: 25500 N/m
Weight: 7,8 kg/m²
Temp. range dry: -40÷80 °C
Temp. range wet: -40÷65 °C
Pin material: PBT white

MX - Code 03

Performance PBT

Max w. load: 20000 N/m
Weight: 7,5 kg/m²
Temp. range dry: -40÷120 °C
Temp. range wet: -40÷60 °C
Pin material: POM grey

MPX - Code 25

Lubricated Acetal

Max w. load: 25000 N/m
Weight: 7,8 kg/m²
Temp. range dry: -40÷80 °C
Temp. range wet: -40÷65 °C
Pin material: PBT white

PFX - Code 30

Extra performance PBT

Max w. load: 20000 N/m
Weight: 7,5 kg/m²
Temp. range dry: -40÷120 °C
Temp. range wet: -40÷60 °C
Pin material: POM grey

**THE BEST CHOICE FOR
DRY RUNNING APPLICATIONS**

Version A - Standard

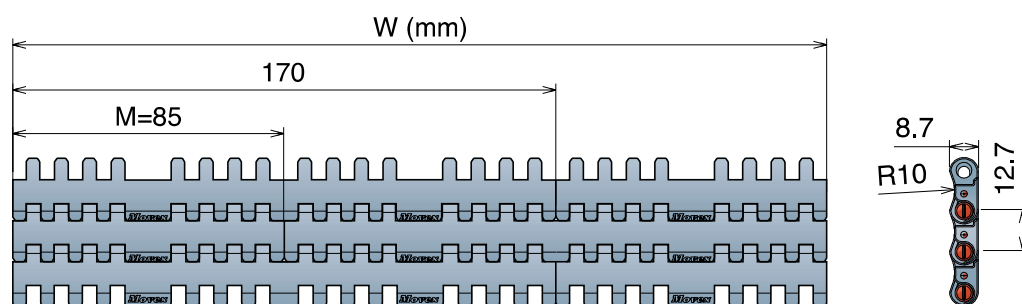

Version B - With 1 Positioner

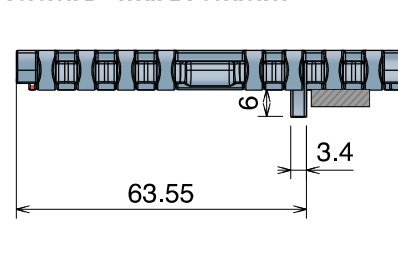

Version C - With 2 Positioners

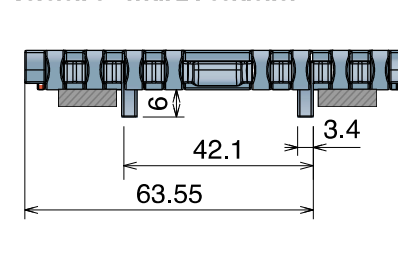

Version A - Standard

Series	Material	Width	Version
5211	*	0085	A
5211	*	0170	A
5211	*	0255	A
5211	*	0340	A
5211	*	0425	A
5211	*	0510	A
5211	*	0595	A
5211	*	0680	A

Version B - With 1 Positioner

Series	Material	Width	Version
5211	*	0085	B
5211	*	0170	B
5211	*	0255	B
5211	*	0340	B
5211	*	0425	B
5211	*	0510	B
5211	*	0595	B
5211	*	0680	B

Version C - With 2 Positioners

Series	Material	Width	Version
5211	*	0085	C
5211	*	0170	C
5211	*	0255	C
5211	*	0340	C
5211	*	0425	C
5211	*	0510	C
5211	*	0595	C
5211	*	0680	C



Advantages:

- Improved working load
- Easy installation
- Rigidity
- Product stability

520 FTT

Tappeto Modulare 520 FTT, H=8,7 M=85



Modular Belt Series 520 FTT, H=8,7 M=85 / Modulare Mattenkette 520 FTT, H=8,7 M=85

CODE STRUCTURE GUIDE (Example)

Backflex radius min.: 10 mm

5206	01	0085	C
Series	*Material	Width	Version

12.7mm
PITCH

		
pg. 357-358	307/311/314	pg. 771-781

*Material

LFA - Code 01	MX - Code 03
Low friction Acetal	Performance PBT

Max w. load: 21500 N/m	Max w. load: 17500 N/m
Weight: 7,8 kg/m ²	Weight: 7,5 kg/m ²
Temp. range dry: -40÷80 °C	Temp. range dry: -40÷120 °C
Temp. range wet: -40÷65 °C	Temp. range wet: -40÷60 °C
Pin material: PBT white	Pin material: POM grey

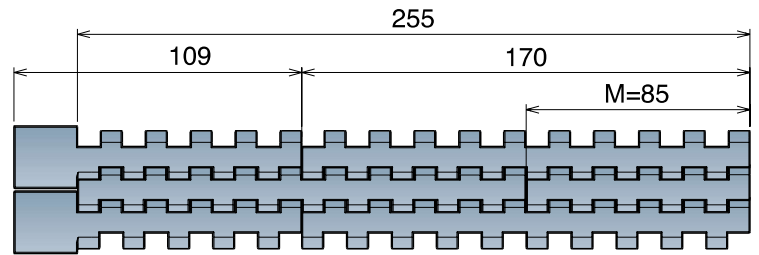
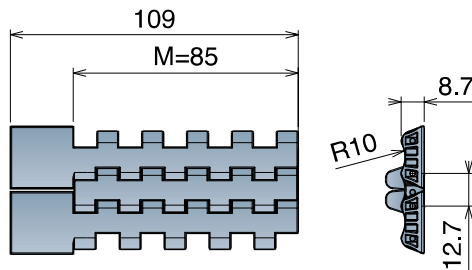
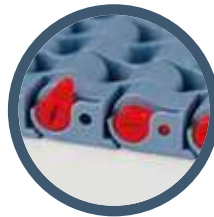
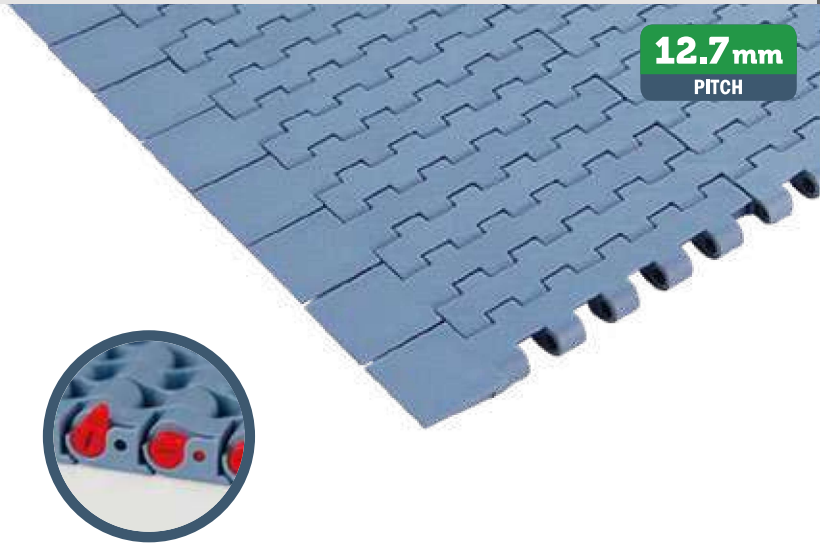

Version C

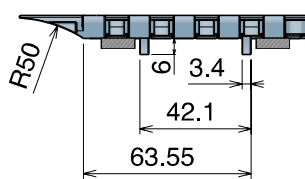

Version CN - Near

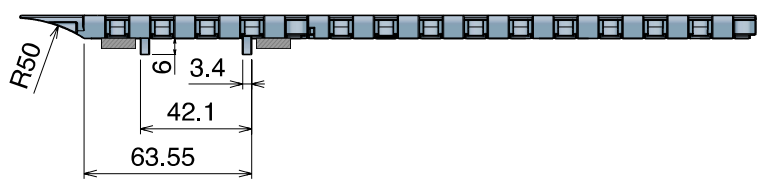

Version C

Series	Material	Width	Version
5206	*	0085	C

Version CO - Opposite

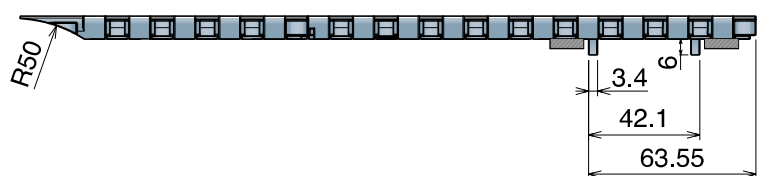

Max working load (N)

Width	85
LFA	1850
MX	1500

Version CN - Near

Series	Material	Width	Version
5206	*	0170	CN
5206	*	0255	CN

Version CO - Opposite

Series	Material	Width	Version
5206	*	0170	CO
5206	*	0255	CO

520 FG Open Surface 25% Tappeto Modulare 520 FG, H=8,7 M=85 Modular Belt Series 520 FG, H=8,7 M=85 / Modulare Mattenkette 520 FG, H=8,7 M=85



Metric Size

CODE STRUCTURE GUIDE (Example)

Backflex radius min.: 10 mm

5202	01	0085	A
Series	*Material	Width	Version

12.7mm
PITCH

		
pg. 357-358	307/311/314	pg. 771 > 781

*Material

LFA - Code 01

Low friction Acetal

Easy Delivery

Max w. load: 21500 N/m
Weight: 7,5 kg/m²
Temp. range dry: -40÷80 °C
Temp. range wet: -40÷65 °C
Pin material: PBT white

PP - Code 02

Polypropylene

Max w. load: 13000 N/m
Weight: 7,5 kg/m²
Temp. range dry: 4+104 °C
Temp. range wet: 4+104 °C
Pin material: PP blue

MX - Code 03

Performance PBT

Max w. load: 17500 N/m
Weight: 7,2 kg/m²
Temp. range dry: -40+120 °C
Temp. range wet: -40+60 °C
Pin material: POM grey

DKM - Code 16

Aramide Reinforced Acetal

Max w. load: 21500 N/m
Weight: 7,5 kg/m²
Temp. range dry: -40÷80 °C
Temp. range wet: -40÷65 °C
Pin material: PBT white

MWX - Code 17

Polyamide Composite

Max w. load: 21500 N/m
Weight: 7,8 kg/m²
Temp. range dry: -40+104 °C
Temp. range wet: NR
Pin material: PBT white

LFB - Code 23

Low friction Acetal

Max w. load: 21500 N/m
Weight: 7,5 kg/m²
Temp. range dry: -40+80 °C
Temp. range wet: -40+65 °C
Pin material: PBT white

MPX - Code 25

Lubricated Acetal

Max w. load: 21500 N/m
Weight: 7,5 kg/m²
Temp. range dry: -40÷80 °C
Temp. range wet: -40÷65 °C
Pin material: PBT white

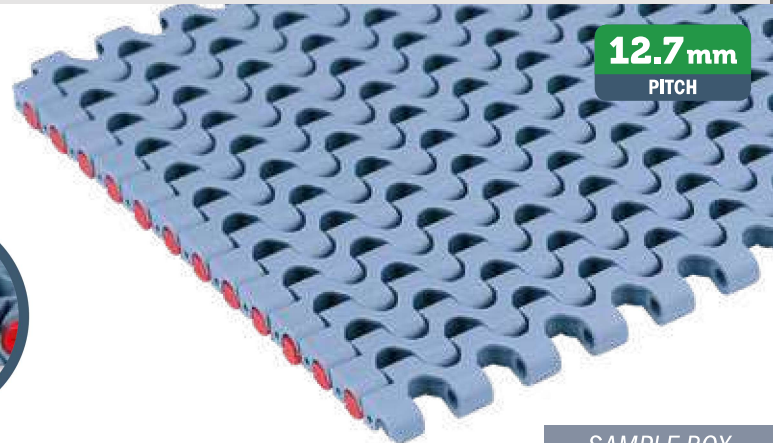
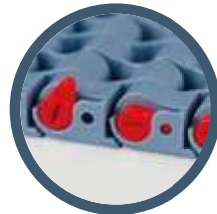

Version A - Standard

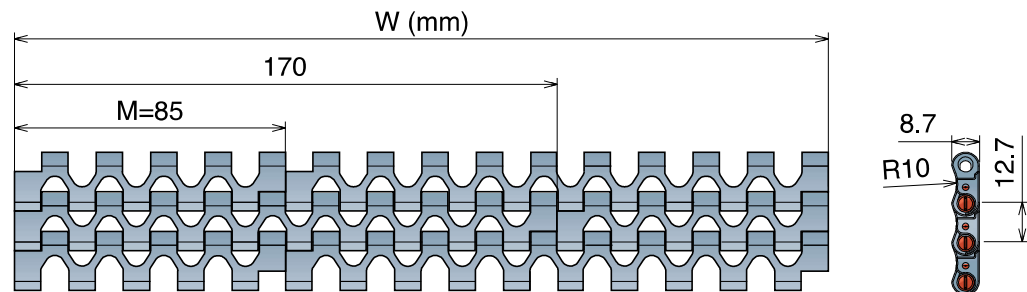

Version B - With 1 Positioner

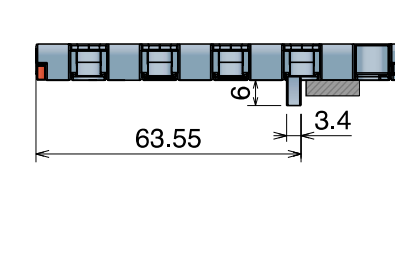

Version C - With 2 Positioner

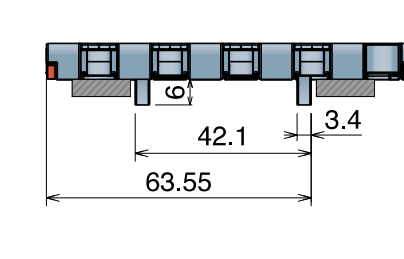

Version A - Standard

Series	Material	Width	Version
5202	*	0085	A
5202	*	0170	A
5202	*	0255	A
5202	*	0340	A
5202	*	0425	A
5202	*	0510	A
5202	*	0595	A
5202	*	0680	A
5202	*	0765	A
5202	*	0850	A
5202	*	0935	A
5202	*	1020	A
5202	*	1105	A
5202	*	1190	A
5202	*	1275	A
5202	*	1360	A
5202	*	1445	A
5202	*	1530	A

Version B - With 1 Positioner

Series	Material	Width	Version
5202	*	0085	B
5202	*	0170	B
5202	*	0255	B
5202	*	0340	B
5202	*	0425	B
5202	*	0510	B
5202	*	0595	B
5202	*	0680	B
5202	*	0765	B
5202	*	0850	B
5202	*	0935	B
5202	*	1020	B
5202	*	1105	B
5202	*	1190	B
5202	*	1275	B
5202	*	1360	B
5202	*	1445	B
5202	*	1530	B

Version C - With 2 Positioners

Series	Material	Width	Version
5202	*	0085	C
5202	*	0170	C
5202	*	0255	C
5202	*	0340	C
5202	*	0425	C
5202	*	0510	C
5202	*	0595	C
5202	*	0680	C
5202	*	0765	C
5202	*	0850	C
5202	*	0935	C
5202	*	1020	C
5202	*	1105	C
5202	*	1190	C
5202	*	1275	C
5202	*	1360	C
5202	*	1445	C
5202	*	1530	C

520 GT

Tappeto Modulare 520 GT, H=8,7 M=85
 Modular Belt Series 520 GT, H=8,7 M=85 / Modulare Mattenkette 520 GT, H=8,7 M=85

CODE STRUCTURE GUIDE (Example)

Backflex radius min.: 20 mm

5203	01	0085	A
Series	*Material	Width	Version

pg. 357-358	307/311/314	pg. 771-781

SAMPLE BOX

Art.-Nr. **520301888A**

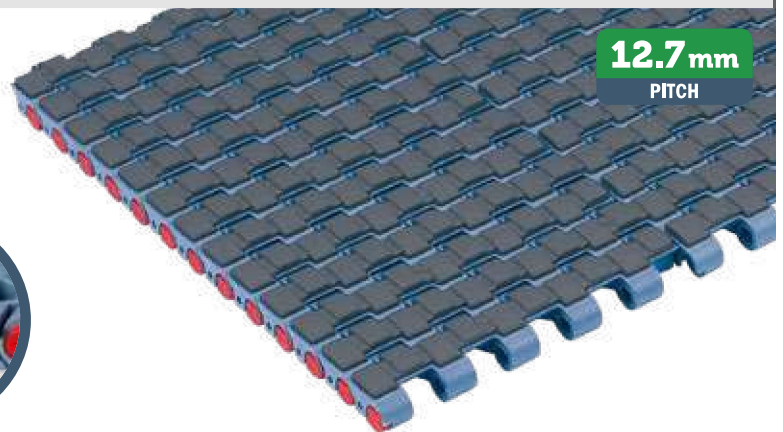

12.7mm
PITCH

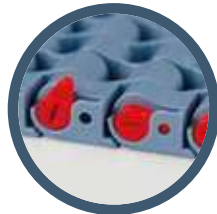

Metric Size

*Material

LFA - Code 01

Low friction Acetal

Easy Delivery

Max w. load: 21500 N/m
 Weight: 9,0 kg/m²
 Temp. range dry: -40+80 °C
 Temp. range wet: -40+65 °C
 Pin material: PBT white
 Top rubber: 50 ShA-Dark grey

PP - Code 02

Polypropylene

Max w. load: 13000 N/m
 Weight: 7,5 kg/m²
 Temp. range dry: 4+80 °C
 Temp. range wet: 4+80 °C
 Pin material: PP blu
 Top rubber: 50 ShA-Pigeon blue

MX - Code 03

Performance PBT

Max w. load: 17500 N/m
 Weight: 9,3 kg/m²
 Temp. range dry: -40+120 °C
 Temp. range wet: -40+60 °C
 Pin material: POM grey
 Top rubber: 50 ShA-Dark grey

Version A - Standard

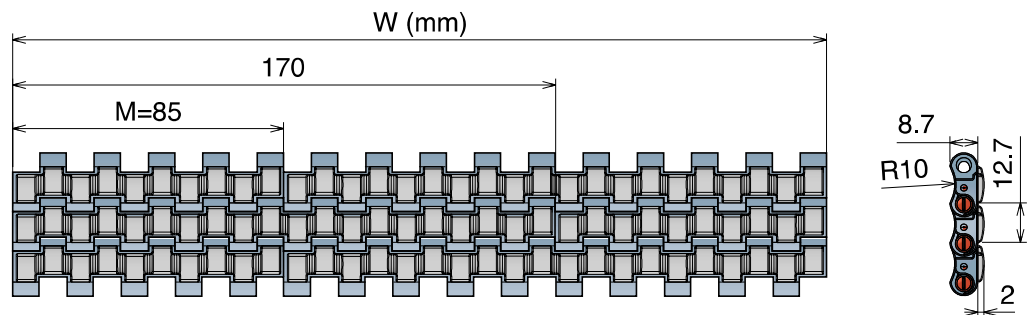

Version B - With 1 Positioner

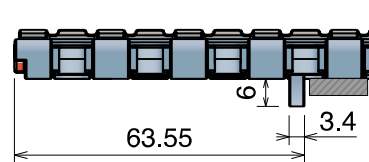

Version C - With 2 Positioner

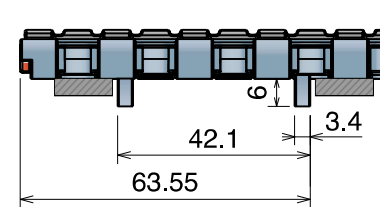

Version A - Standard

Series	Material	Width	Version
5203	*	0085	A
5203	*	0170	A
5203	*	0255	A
5203	*	0340	A
5203	*	0425	A
5203	*	0510	A
5203	*	0595	A
5203	*	0680	A
5203	*	0765	A
5203	*	0850	A
5203	*	0935	A
5203	*	1020	A
5203	*	1105	A
5203	*	1190	A
5203	*	1275	A
5203	*	1360	A
5203	*	1445	A
5203	*	1530	A

Version B - With 1 Positioner

Series	Material	Width	Version
5203	*	0085	B
5203	*	0170	B
5203	*	0255	B
5203	*	0340	B
5203	*	0425	B
5203	*	0510	B
5203	*	0595	B
5203	*	0680	B
5203	*	0765	B
5203	*	0850	B
5203	*	0935	B
5203	*	1020	B
5203	*	1105	B
5203	*	1190	B
5203	*	1275	B
5203	*	1360	B
5203	*	1445	B
5203	*	1530	B

Version C - With 2 Positioners

Series	Material	Width	Version
5203	*	0085	C
5203	*	0170	C
5203	*	0255	C
5203	*	0340	C
5203	*	0425	C
5203	*	0510	C
5203	*	0595	C
5203	*	0680	C
5203	*	0765	C
5203	*	0850	C
5203	*	0935	C
5203	*	1020	C
5203	*	1105	C
5203	*	1190	C
5203	*	1275	C
5203	*	1360	C
5203	*	1445	C
5203	*	1530	C

NEW

520 GT Side indent

Tappeto Modulare 520 GT Side Indent, H=8,7 M=85

Modular Belt Series 520 GT Side Indent, H=8,7 M=85 / Modulare Mattenkette 520 GT Side Indent, H=8,7 M=85

Metric Size

CODE STRUCTURE GUIDE (Example)

Backflex radius min.: 20 mm

5205	01	0085	A
Series	*Material	Width	Version

12.7mm
PITCH

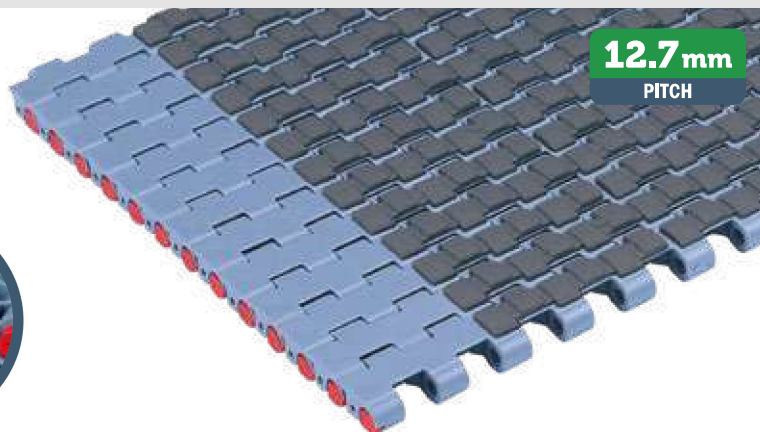

pg. 357-358	307/311/314	pg. 771>781

SAMPLE BOX

Art.-Nr. **5205018888A**

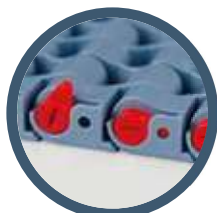

*Material

LFA - Code 01

Low friction Acetal

Easy Delivery

Max w. load: 21500 N/m
Weight: 9,0 kg/m²
Temp. range dry: -40÷80 °C
Temp. range wet: -40÷65 °C
Pin material: PBT white
Top rubber: 50 ShA-Dark grey

PP - Code 02

Polypropylene

Max w. load: 13000 N/m
Weight: 7,5 kg/m²
Temp. range dry: 4÷80 °C
Temp. range wet: 4÷80 °C
Pin material: PP blu
Top rubber: 50 ShA-Pigeon blue

MX - Code 03

Performance PBT

Max w. load: 17500 N/m
Weight: 9,3 kg/m²
Temp. range dry: -40÷120 °C
Temp. range wet: -40÷60 °C
Pin material: POM grey
Top rubber: 50 ShA-Dark grey

Version A - Standard

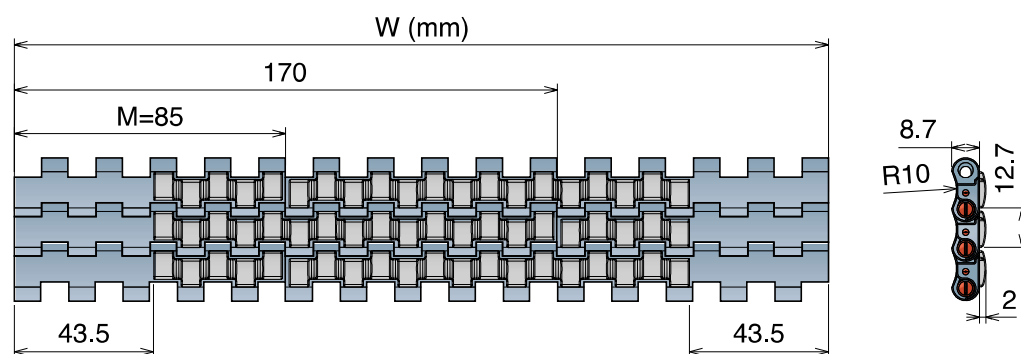

Version B - With 1 Positioner

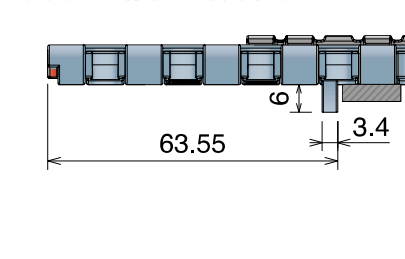

Version C - With 2 Positioner

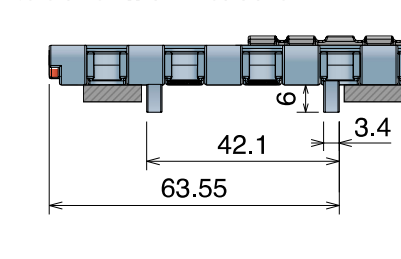

Version A - Standard

Series	Material	Width	Version
5205	*	0085	A
5205	*	0170	A
5205	*	0255	A
5205	*	0340	A
5205	*	0425	A
5205	*	0510	A
5205	*	0595	A
5205	*	0680	A
5205	*	0765	A
5205	*	0850	A
5205	*	0935	A
5205	*	1020	A
5205	*	1105	A
5205	*	1190	A
5205	*	1275	A
5205	*	1360	A
5205	*	1445	A
5205	*	1530	A

Version B - With 1 Positioner

Series	Material	Width	Version
5205	*	0085	B
5205	*	0170	B
5205	*	0255	B
5205	*	0340	B
5205	*	0425	B
5205	*	0510	B
5205	*	0595	B
5205	*	0680	B
5205	*	0765	B
5205	*	0850	B
5205	*	0935	B
5205	*	1020	B
5205	*	1105	B
5205	*	1190	B
5205	*	1275	B
5205	*	1360	B
5205	*	1445	B
5205	*	1530	B

Version C - With 2 Positioners

Series	Material	Width	Version
5205	*	0085	C
5205	*	0170	C
5205	*	0255	C
5205	*	0340	C
5205	*	0425	C
5205	*	0510	C
5205	*	0595	C
5205	*	0680	C
5205	*	0765	C
5205	*	0850	C
5205	*	0935	C
5205	*	1020	C
5205	*	1105	C
5205	*	1190	C
5205	*	1275	C
5205	*	1360	C
5205	*	1445	C
5205	*	1530	C

520 LBP



Tappeto Modulare 520 LBP, H=8,7 M=85

Modular Belt Series 520 LBP, H=8,7 M=85 / Modulare Mattenkette 520 LBP, H=8,7 M=85

CODE STRUCTURE GUIDE (Example)

Backflex radius min.: 65 mm

5204	01	0085	A
Series	*Material	Width	Version

		
pg. 357-358	307/311/314	pg. 771>781

SAMPLE BOX	
Art.-Nr.	5204010888A

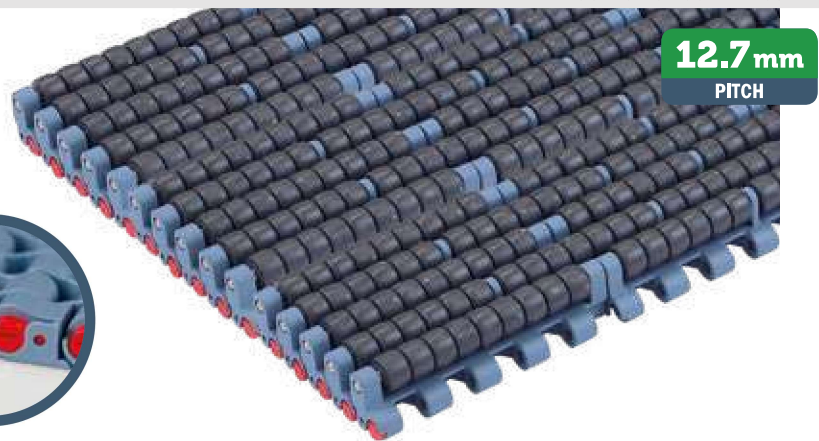

12.7mm
PITCH

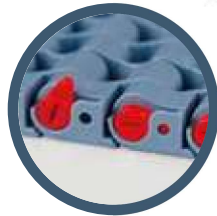

Version A - Standard

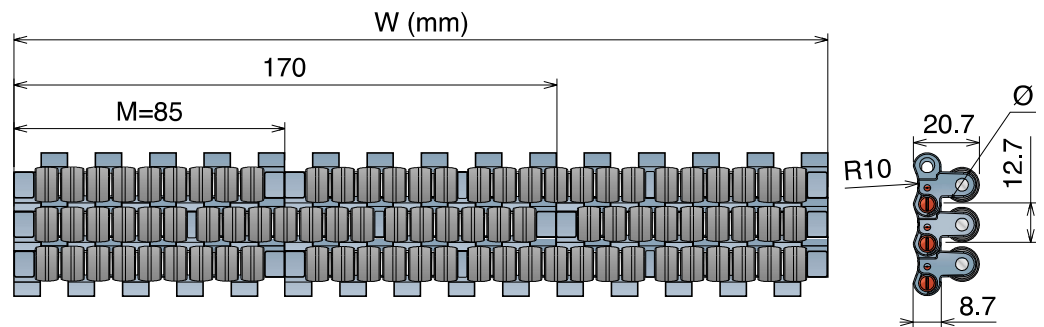

Version B - With 1 Positioner

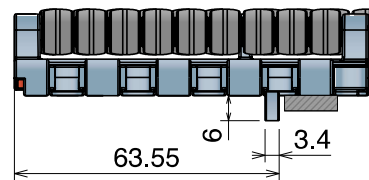

Version C - With 2 Positioner

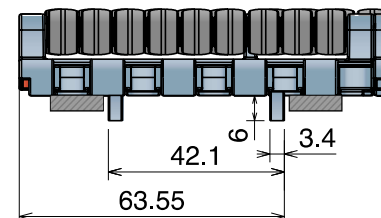

*Material

LFA - Code 01

Low friction Acetal

Max w. load: 21500 N/m
 Weight: 24,0 kg/m²
 Temp. range dry: -40+80 °C
 Temp. range wet: -40+65 °C
 Pin material: PBT white

Version A - Standard

Series	Material	Width	Version
5204	01	0085	A
5204	01	0170	A
5204	01	0255	A
5204	01	0340	A
5204	01	0425	A
5204	01	0510	A
5204	01	0595	A
5204	01	0680	A
5204	01	0765	A
5204	01	0850	A
5204	01	0935	A
5204	01	1020	A
5204	01	1105	A
5204	01	1190	A
5204	01	1275	A
5204	01	1360	A
5204	01	1445	A
5204	01	1530	A

Version B - With 1 Positioner

Series	Material	Width	Version
5204	01	0085	B
5204	01	0170	B
5204	01	0255	B
5204	01	0340	B
5204	01	0425	B
5204	01	0510	B
5204	01	0595	B
5204	01	0680	B
5204	01	0765	B
5204	01	0850	B
5204	01	0935	B
5204	01	1020	B
5204	01	1105	B
5204	01	1190	B
5204	01	1275	B
5204	01	1360	B
5204	01	1445	B
5204	01	1530	B

Version C - With 2 Positioners

Series	Material	Width	Version
5204	01	0085	C
5204	01	0170	C
5204	01	0255	C
5204	01	0340	C
5204	01	0425	C
5204	01	0510	C
5204	01	0595	C
5204	01	0680	C
5204	01	0765	C
5204	01	0850	C
5204	01	0935	C
5204	01	1020	C
5204	01	1105	C
5204	01	1190	C
5204	01	1275	C
5204	01	1360	C
5204	01	1445	C
5204	01	1530	C

PATENTED

Belts wider than standard are available with 85 mm increments

520 PRO LBP

Tappeto Modulare 520 PRO LBP, H=8,7 M=85
 Modular Belt Series 520 PRO LBP, H=8,7 M=85 / Modulare Mattenkette 520 PRO LBP, H=8,7 M=85

CODE STRUCTURE GUIDE (Example)

Backflex radius min.: 40 mm

5209	01	0085	A
Series	*Material	Width	Version

	NoseBars	
pg. 355-356	307/311/314	pg. 771>781

SAMPLE BOX

Art.-Nr. **5210018888A**

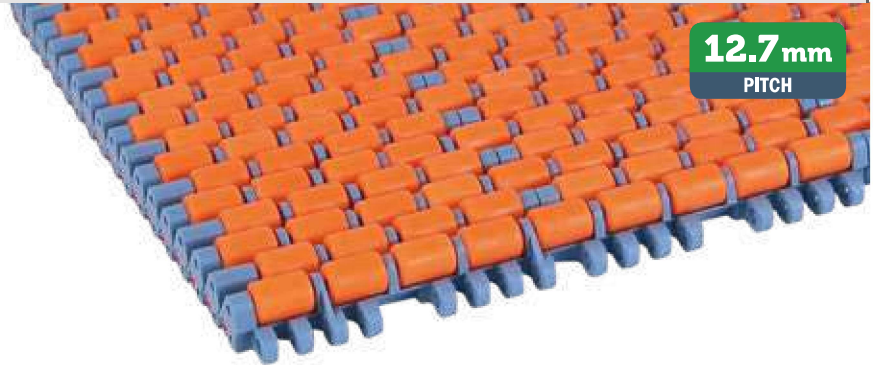

12.7mm
PITCH

Metric Size

Material

LFA - Code 01

Low friction Acetal

- Max w. load: 25000 N/m
- Weight SS pin: 19,0 kg/m²
- Weight Plastic pin: 15,3 kg/m²
- Temp. range dry: -40+80 °C
- Temp. range wet: -40+65 °C
- Pin material: PBT white

PFX Roller

THE BEST CHOICE TO REACH
THE LOWEST FRICTION



Bottom view

Version A - Standard

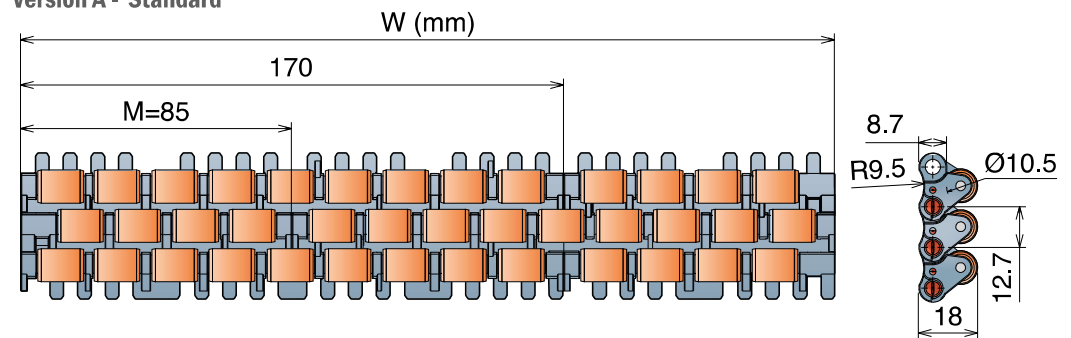

Version B - With 1 Positioner

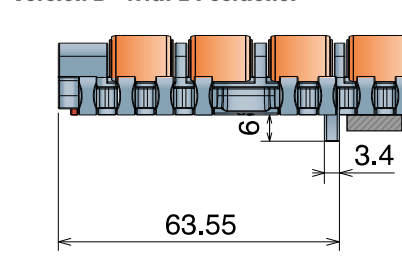

Version C - With 2 Positioner

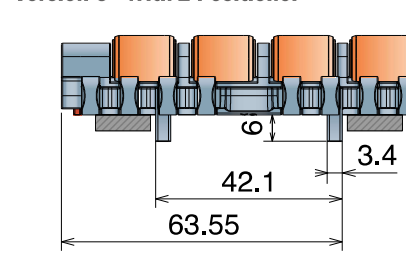

Stainless steel Pin



Plastic Pin

Series	Material	Width	Version
5209	01	0085	*
5209	01	0170	*
5209	01	0255	*
5209	01	0340	*
5209	01	0425	*
5209	01	0510	*
5209	01	0595	*
5209	01	0680	*
5209	01	0765	*
5209	01	0850	*
5209	01	0935	*
5209	01	1020	*
5209	01	1105	*
5209	01	1190	*
5209	01	1275	*
5209	01	1360	*
5209	01	1445	*
5209	01	1530	*

Series	Material	Width	Version
5210	01	0085	*
5210	01	0170	*
5210	01	0255	*
5210	01	0340	*
5210	01	0425	*
5210	01	0510	*
5210	01	0595	*
5210	01	0680	*
5210	01	0765	*
5210	01	0850	*
5210	01	0935	*
5210	01	1020	*
5210	01	1105	*
5210	01	1190	*
5210	01	1275	*
5210	01	1360	*
5210	01	1445	*
5210	01	1530	*

*Version	
Standard	Add A
With 1 Positioner	Add B
With 2 Positioners	Add C

Metric Size

520 M

Tappeto Modulare 520 M, H=8,7 K 330
Modular Belt Series 520 M, H=8,7 K 330 / Modulare Mattenkette 520 M, H=8,7 K 330

Part	Article-Nr.	Ref.	Weight Kg/m	* Material
1193	1195019330	LFA 520 M K330	1,11	LFA
1193	1195039330	MX 520 M K330	1,11	MX
1193	1195309330	PFX 520 M K330	1,11	PFX

Backflex radius min.: 15 mm

12.7mm
PITCH

10 feet 3,048 m	pg. 357-358	307/311/314	pg. 163->169	pg. 771->781
--------------------	-------------	-------------	--------------	--------------

SAMPLE BOX
Art.-Nr. **1195018888A**

MAGNETIC SYSTEM



- Easier installation • Quicker maintenance
- Interchangeable with previous design

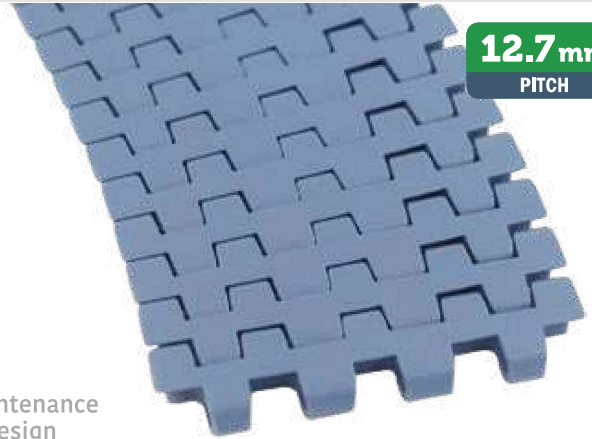

* Material

LFA - Code 01
Low friction Acetal

Easy Delivery

Max w. load: 2500 N
Temp. range dry: -40+80 °C
Temp. range wet: -40+65 °C
Pin: Ferritic stainless steel

MX - Code 03
Performance PBT

Max w. load: 2000 N
Temp. range dry: -40+120 °C
Temp. range wet: -40+60 °C
Pin: Ferritic stainless steel

PFX - Code 30
Extra performance PBT

Max w. load: 2000 N
Temp. range dry: -40+120 °C
Temp. range wet: -40+60 °C
Pin: Ferritic stainless steel

**THE BEST CHOICE FOR
DRY RUNNING APPLICATIONS**

Version A - Standard

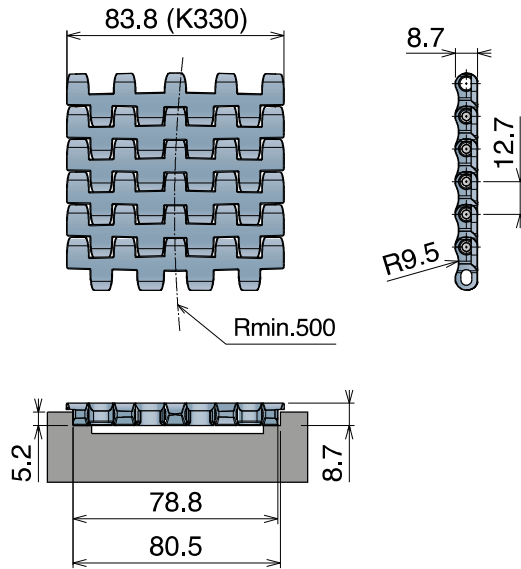

Advantages:

- No conveyor side transfers required
- Space savings
- Less components required
- Less drives required

Coventional layout

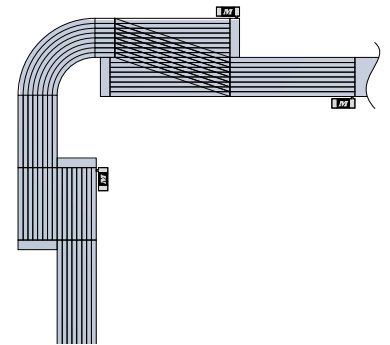

Layout with 520 M K330

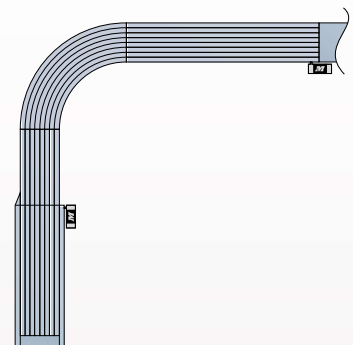

520 M
MOVEX TOOL

The specific tool for 520 M developed to facilitate belt assembly and disassembly.



Article Nr. **29968**

Movex tools are made with 3D printer, the color may vary due to availability of the material.

521/522 Series

521/522

Pitch 12,7 mm

H= 8,7 mm



Imperial Size

Metric Size

521 FT

521 FT *One track belt*

522 HD FT

522 HD FT *One track belt*

Movex[®]

NEW 521 FT



Tappeto Modulare 521 FT, H=8,7
Modular Belt Series 521 FT, H=8,7 / Modulare Mattenkette 521 FT, H=8,7

Imperial Size

CODE STRUCTURE GUIDE (Example)

Backflex radius min.: 10 mm

5311	01	003	A
Series	*Material	Width	Version

		
pg. 355-356	308/311/314	pg. 771-781

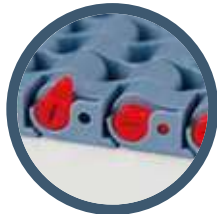
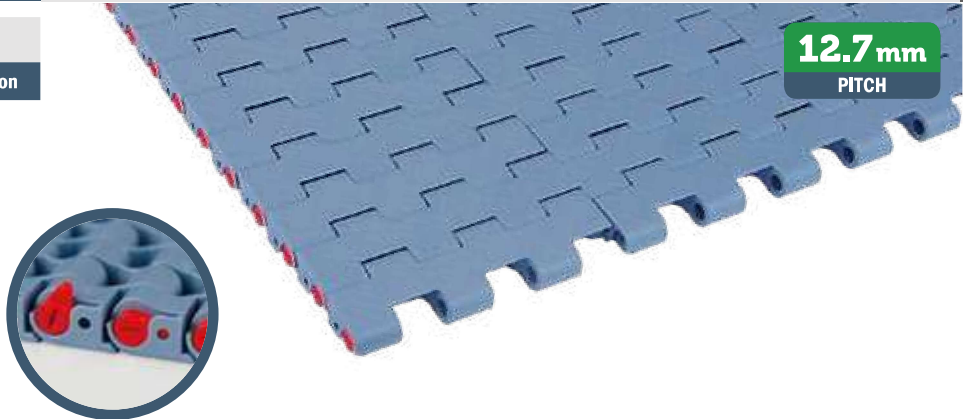

*Material

LFA - Code 01

Low friction Acetal

Easy Delivery

Max w. load: 21500 N/m
Weight: 8,0 kg/m²
Temp. range dry: -40÷80 °C
Temp. range wet: -40÷65 °C
Pin material: PBT white

MX - Code 03

Performance PBT

Max w. load: 17500 N/m
Weight: 7,8 kg/m²
Temp. range dry: -40÷120 °C
Temp. range wet: -40÷60 °C
Pin material: POM grey

DKM - Code 16

Aramide Reinforced Acetal

Max w. load: 21500 N/m
Weight: 8,0 kg/m²
Temp. range dry: -40÷80 °C
Temp. range wet: -40÷65 °C
Pin material: PBT white

MWX - Code 17

Polyamide Composite

Max w. load: 21500 N/m
Weight: 8,3 kg/m²
Temp. range dry: -40÷104 °C
Temp. range wet: NR
Pin material: PBT white

MPX - Code 25

Lubricated Acetal

Max w. load: 2500 N
Weight: 8,9 kg/m²
Temp. range dry: -40÷104 °C
Temp. range wet: NR
Pin material: PBT white

PFX - Code 30

Extra performance PBT

Max w. load: 17500 N/m
Weight: 7,8 kg/m²
Temp. range dry: -40÷120 °C
Temp. range wet: -40÷60 °C
Pin material: POM grey

**THE BEST CHOICE FOR
DRY RUNNING APPLICATIONS**

Version A - Standard

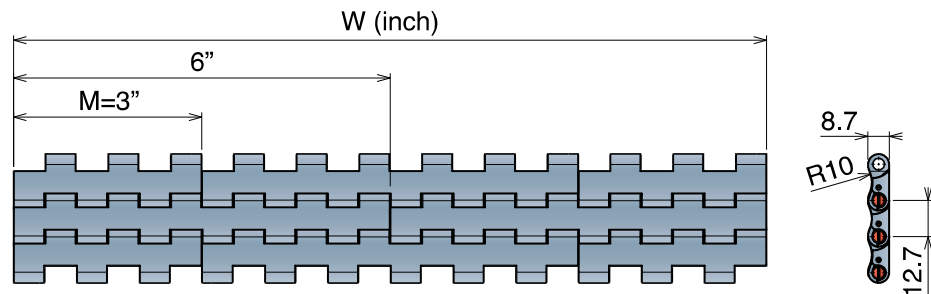

Version A - Standard

Series	Material	Width	Version
5311	01	0003	A
5311	01	0006	A
5311	01	0009	A
5311	01	0012	A
5311	01	0015	A
5311	01	0018	A
5311	01	0021	A
5311	01	0024	A
5311	01	0027	A
5311	01	0030	A
5311	01	0033	A
5311	01	0036	A
5311	01	0039	A
5311	01	0042	A
5311	01	0045	A
5311	01	0048	A
5311	01	0051	A
5311	01	0054	A

521 FT One track Belt

Tappeto Modulare 521 FT, H=8,7
Modular Belt Series 521 FT, H=8,7 / Modulare Mattenkette 521 FT, H=8,7



Imperial Size

CODE STRUCTURE GUIDE (Example)

Backflex radius min.: 10 mm

5311	01	9750	A
Series	*Material	Width	Version

12.7mm
PITCH

		
pg. 355-356	308/311/314	pg. 771>781

*Material

LFA - Code 01

Low friction Acetal

Weight: 8,0 kg/m²
Temp. range dry: -40÷80 °C
Temp. range wet: -40÷65 °C
Pin material: PBT white

MX - Code 03

Performance PBT

Weight: 7,8 kg/m²
Temp. range dry: -40÷120 °C
Temp. range wet: -40÷60 °C
Pin material: POM grey

DKM - Code 16

Aramide Reinforced Acetal

Weight: 8,0 kg/m²
Temp. range dry: -40÷80 °C
Temp. range wet: -40÷65 °C
Pin material: PBT white

MWX - Code 17

Polyamide Composite

Weight: 8,3 kg/m²
Temp. range dry: -40÷104 °C
Temp. range wet: NR
Pin material: PBT white

MPX - Code 25

Lubricated Acetal

Weight: 8,0 kg/m²
Temp. range dry: -40÷80 °C
Temp. range wet: -40÷65 °C
Pin material: PBT white

PFX - Code 30

Extra performance PBT

Weight: 7,8 kg/m²
Temp. range dry: -40÷120 °C
Temp. range wet: -40÷60 °C
Pin material: POM grey

Max working load (N)

Width	K450	K750
LFA	2400	4000
MX	2000	3300
DKM	2400	4000
MWX	2400	4000
MPX	2400	4000
PFX	2000	3300



K450

Version A - Standard

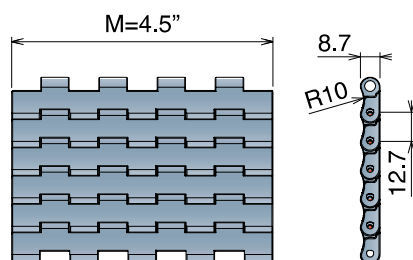

Version C - With 2 Positioner

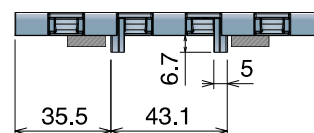

Series	Material	Width	Version
5311	*	9450	A
5311	*	9450	C

K750

Version A - Standard

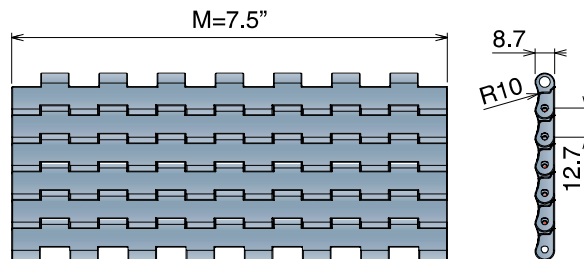

Version C - With 2 Positioner

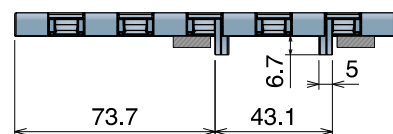

Series	Material	Width	Version
5311	*	9750	A
5311	*	9750	C



522 HD FT Tappeto Modulare 522 HD, H=8,7 M=50 Modular Belt Series 522 HD, H=8,7 M=50 / Modulare Mattenkette 522 HD, H=8,7 M=50

CODE STRUCTURE GUIDE (Example)

Backflex radius min.: 10 mm

5271	01	0100	A
Series	*Material	Width	Version

12.7mm
PITCH

		
pg. 355-356	308/312/315	pg. 771-781

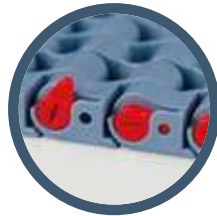

*Material

LFA - Code 01

Low friction Acetal

Easy Delivery

Max w. load: 25500 N/m
Weight: 7,8 kg/m²
Temp. range dry: -40÷80 °C
Temp. range wet: -40÷65 °C
Pin material: PBT white

MX - Code 03

Performance PBT

Max w. load: 20000 N/m
Weight: 7,5 kg/m²
Temp. range dry: -40÷120 °C
Temp. range wet: -40÷60 °C
Pin material: POM grey

PFX - Code 30

Extra performance PBT

Max w. load: 20000 N/m
Weight: 7,5 kg/m²
Temp. range dry: -40÷120 °C
Temp. range wet: -40÷60 °C
Pin material: POM grey

**THE BEST CHOICE FOR
DRY RUNNING APPLICATIONS**

Version A - Standard

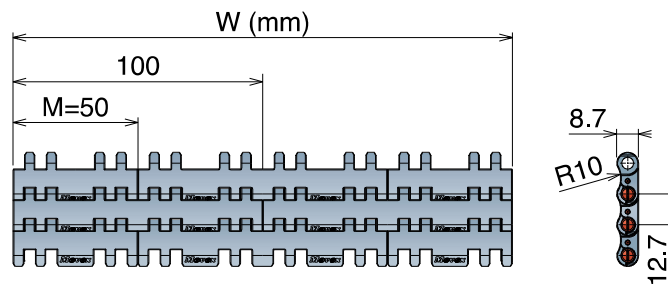

Version C - With 2 Positioner

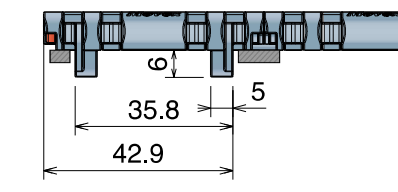

Version A - Standard

Series	Material	Width	Version
5271	*	0100**	A
5271	*	0150	A
5271	*	0200	A
5271	*	0250	A
5271	*	0300	A

Version C - With 2 Positioners

Series	Material	Width	Version
5271	*	0100**	C
5271	*	0150	C
5271	*	0200	C
5271	*	0250	C
5271	*	0300	C

** Belt assembled with Pin Sphere.

522 HD One track belt MOVEX TOOL

The specific tool for belts developed to facilitate belt assembly and disassembly, perfectly compatible also with all 522 HD One-Track belt versions (See next page).



Article Nr. **29971**

Movex tools are made with 3D printer, the color may vary due to availability of the material.

522 HD FT One track Belt



Tappeto Modulare 522 HD, H=8,7
Modular Belt Series 522 HD, H=8,7 / Modulare Mattenkette 522 HD, H=8,7

CODE STRUCTURE GUIDE (Example)

Backflex radius min.: 10 mm

5271	01	9115	A
Series	*Material	Width	Version

12.7mm
PITCH



SAMPLE BOX

pg. 355-356 308/312/315 pg. 771>781 Art.-Nr. **5271018888A**

*Material

Easy Delivery

LFA - Code 01
Low friction Acetal

MX - Code 03
Performance PBT

PFX - Code 30
Extra performance PBT

Max w. load: See table below Weight: 7,8 kg/m ² Temp. range dry: -40+80 °C Temp. range wet: -40+65 °C Pin material: PBT white	Max w. load: See table below Weight: 7,5 kg/m ² Temp. range dry: -40+120 °C Temp. range wet: -40+60 °C Pin material: POM black	Max w. load: See table below Weight: 7,5 kg/m ² Temp. range dry: -40+120 °C Temp. range wet: -40+60 °C Pin material: POM black
---	--	--



Pin Sphere®
 AUTOLOCK

- Easier installation
- Quicker maintenance
- High strength

Width 29 mm

Version C - With 2 Positioner

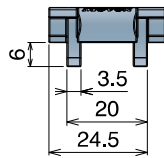
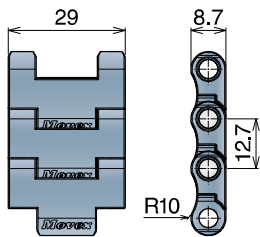
Version A - Standard



Series	Material	Width	Version
5271	*	9115	A
5271	*	9115	C

Width 34 mm

Version C - With 2 Positioner

Version A - Standard

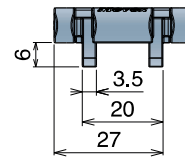
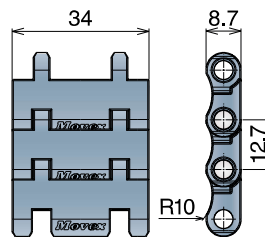

Series	Material	Width	Version
5271	*	9134	A
5271	*	9134	C

Width 37 mm

Version C - With 2 Positioner

Version A - Standard

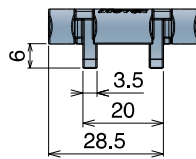
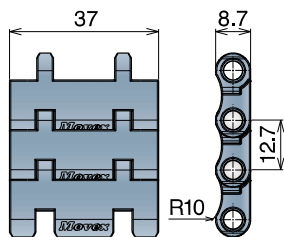

Series	Material	Width	Version
5271	*	9145	A
5271	*	9145	C

Width 51 mm

Version C - With 2 Positioner

Version A - Standard

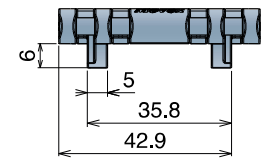
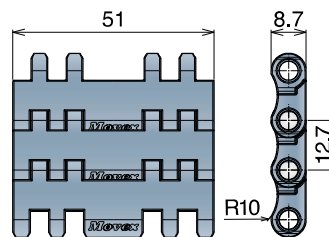

Series	Material	Width	Version
5271	*	9200	A
5271	*	9200	C

Width 76 mm

Version C - With 2 Positioner

Version A - Standard

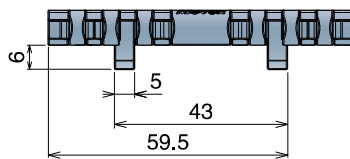
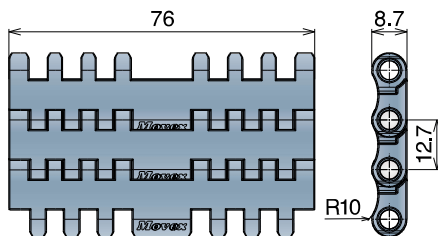

Series	Material	Width	Version
5271	*	9300	A
5271	*	9300	C

Max working load (N)

Width	29	34	37	51	76
LFA	600	870	945	1300	2000
MX	450	680	740	1020	1520
PFX	450	680	740	1020	1520

590 Series

590

Pitch 19,05 mm
H= 8,7 mm



Movex[®]

590 FT
590 FT *One track Belt*
590 FTT
590 FG
590 FG *One track Belt*

590 FT



Tappeto Modulare 590 FT, H=8,7 M=3"
Modular Belt Series 590 FT, H=8,7 M=3" / Modulare Mattenkette 590 FT, H=8,7 M=3"

Imperial Size

CODE STRUCTURE GUIDE (Example)

Backflex radius min.: 25 mm

5301	01	0003	A
Series	*Material	Width	Version

		A
pg. 361	pg. 771>781	Accessories Blueline catalog

SAMPLE BOX	
Art.-Nr.	5301018888A

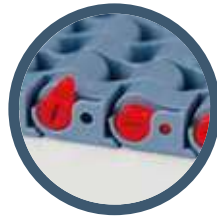
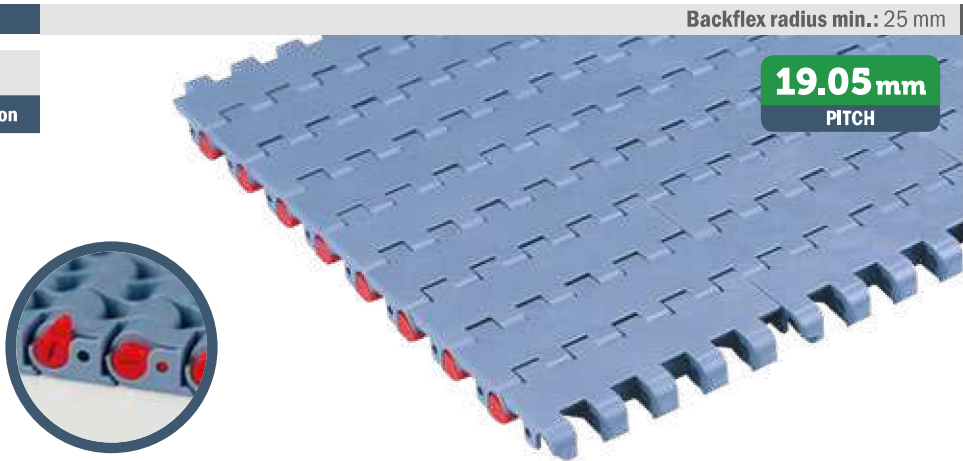

*Material

LFA - Code 01
Low friction Acetal

Easy Delivery

Max w. load: 30000 N/m
Weight: 7,2 kg/m²
Temp. range dry: -40÷80 °C
Temp. range wet: -40÷65 °C
Pin material: PBT white

MX - Code 03
Performance PBT

Max w. load: 24000 N/m
Weight: 7,0 kg/m²
Temp. range dry: -40÷120 °C
Temp. range wet: -40÷60 °C
Pin material: POM grey

MPX - Code 25
Lubricated Acetal

Max w. load: 30000 N/m
Weight: 7,2 kg/m²
Temp. range dry: -40÷80 °C
Temp. range wet: -40÷65 °C
Pin material: PBT white

Version A - Standard

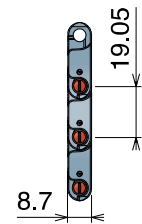
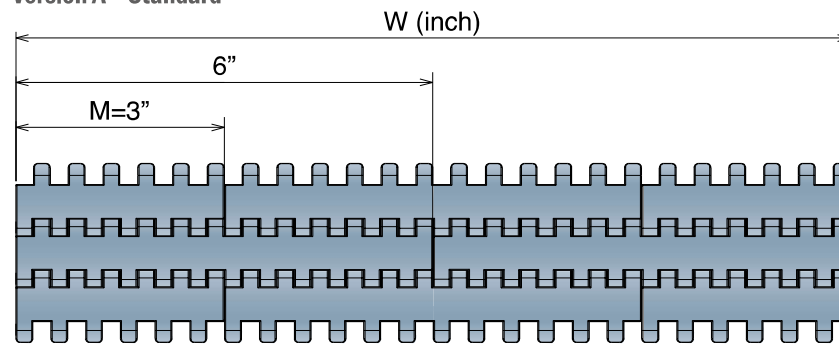

Version C - With 2 Positioner

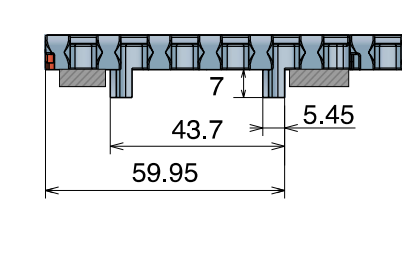

Version A - Standard

Series	Material	Width	Version
5301	*	0003	A
5301	*	0006	A
5301	*	0009	A
5301	*	0012	A
5301	*	0015	A
5301	*	0018	A
5301	*	0021	A
5301	*	0024	A
5301	*	0027	A
5301	*	0030	A
5301	*	0033	A
5301	*	0036	A
5301	*	0039	A
5301	*	0042	A
5301	*	0045	A
5301	*	0048	A
5301	*	0051	A
5301	*	0054	A

Version C - With 2 Positioners

Series	Material	Width	Version
5301	*	0003	C
5301	*	0006	C
5301	*	0009	C
5301	*	0012	C
5301	*	0015	C
5301	*	0018	C
5301	*	0021	C
5301	*	0024	C
5301	*	0027	C
5301	*	0030	C
5301	*	0033	C
5301	*	0036	C
5301	*	0039	C
5301	*	0042	C
5301	*	0045	C
5301	*	0048	C
5301	*	0051	C
5301	*	0054	C

590 FT One track Belt

Tappeti modulari / Modular belts / Mattenketten

Imperial Size

590 FT One track Belt



Tappeto Modulare 590 FT, H=8,7
Modular Belt Series 590 FT, H=8,7 / Modulare Mattenkette 590 FT, H=8,7

CODE STRUCTURE GUIDE (Example)

Backflex radius min.: 25 mm

5301	01	9325	A
Series	*Material	Width	Version

19.05 mm
PITCH

	
pg. 361	pg. 771>781

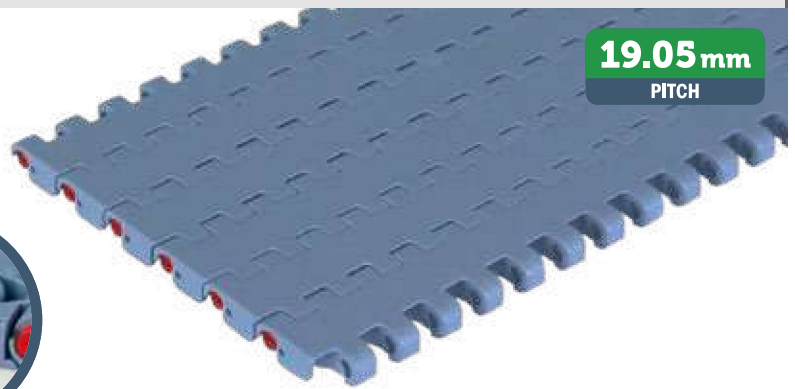
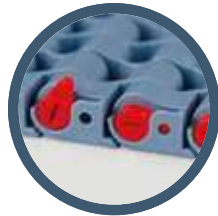

*Material

LFA - Code 01
Low friction Acetal

Easy Delivery

Weight: 7,2 kg/m²
Temp. range dry: -40÷80 °C
Temp. range wet: -40÷65 °C
Pin material: PBT white

MX - Code 03
Performance PBT

Weight: 7,0 kg/m²
Temp. range dry: -40÷120 °C
Temp. range wet: -40÷60 °C
Pin material: POM grey

MPX - Code 25
Lubricated Acetal

Weight: 7,2 kg/m²
Temp. range dry: -40÷80 °C
Temp. range wet: -40÷65 °C
Pin material: PBT white

Max working load (N)

Width	K325	K450	K750
LFA	2500	3400	5700
MX	2000	2800	4500
MPX	2500	3400	5700

Version A - Standard

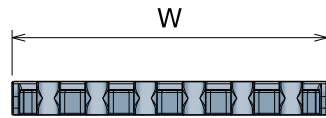

Version C - With 2 Positioner

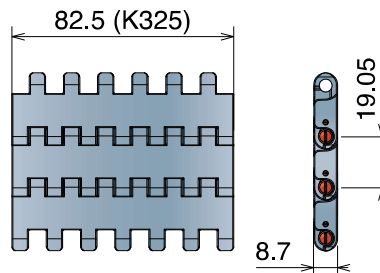
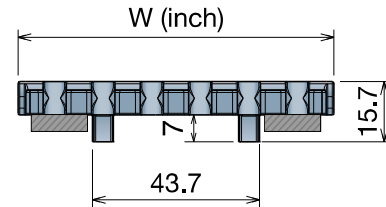

K325 - One track belt

Series	Material	Width	Version
5301	*	9325	A
5301	*	9325	C

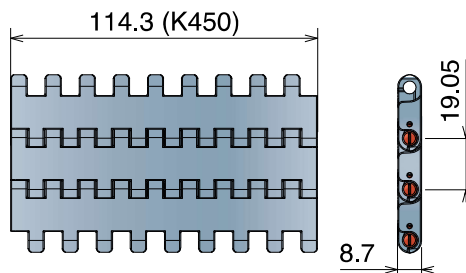

K450 - One track belt

Series	Material	Width	Version
5301	*	9450	A
5301	*	9450	C

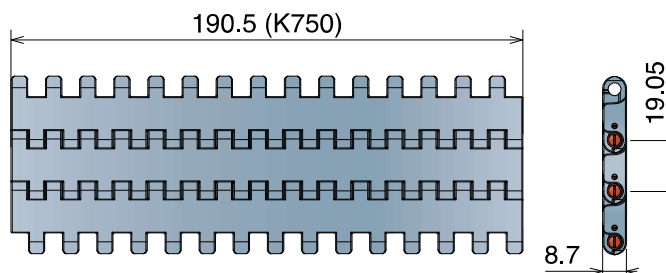

K750 - One track belt

Series	Material	Width	Version
5301	*	9750	A
5301	*	9750	C

Tappeti modulari / Modular belts / Mattenketten

590 FTT

Tappeto Modulare 590 FTT, H=8,7
 Modular Belt Series 590 FTT, H=8,7 / Modulare Mattenkette 590 FTT, H=8,7

Imperial Size

CODE STRUCTURE GUIDE (Example)

Backflex radius min.: 25 mm

5306	01	9450	C-R
Series	*Material	Width	Version

19.05mm
PITCH

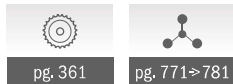

pg. 361

pg. 771>781

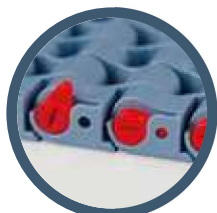

*Material

LFA - Code 01

Low friction Acetal

Weight: 7,2 kg/m²
 Temp. range dry: -40+80 °C
 Temp. range wet: -40+65 °C
 Pin material: PBT white

MX - Code 03

Performance PBT

Weight: 7,0 kg/m²
 Temp. range dry: -40+120 °C
 Temp. range wet: -40+60 °C
 Pin material: POM grey

MPX - Code 25

Lubricated Acetal

Weight: 7,2 kg/m²
 Temp. range dry: -40+80 °C
 Temp. range wet: -40+65 °C
 Pin material: PBT white

Max working load (N)

Width	K450	K750
LFA	3400	5700
MX	2800	4500
MPX	3400	5700

Version 590 FTT DX

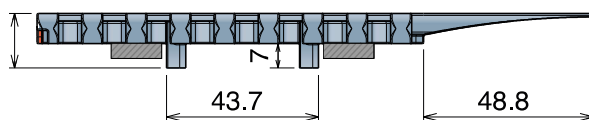

W(inch)

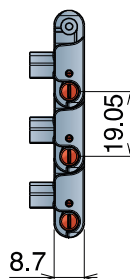
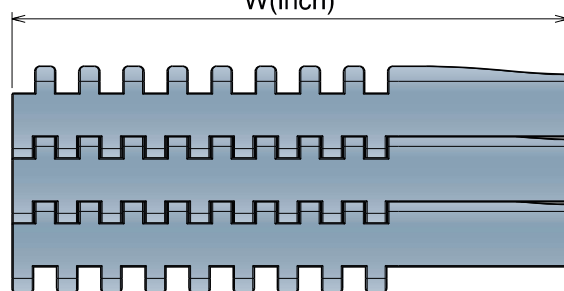

Version 590 FTT SX

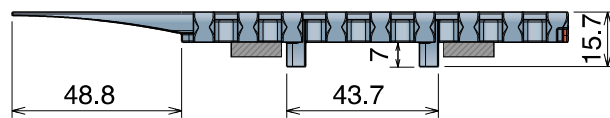

W(inch)

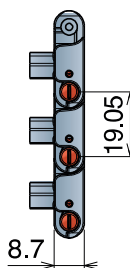
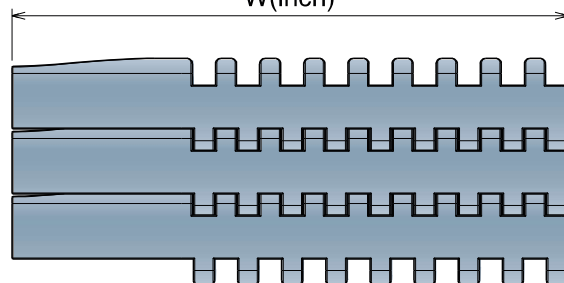

Version 590 FTT DX

Series	Material	Width	Version	Total width
5306	*	9450	C-R	160.0
5306	*	9750	C-R	236.2

Version 590 FTT SX

Series	Material	Width	Version	Total width
5306	*	9450	C-L	160.0
5306	*	9750	C-L	236.2

590 FG

Tappeti modulari / Modular belts / Mattenketten

NEW

590 FG

Tappeto Modulare 590 FG, H=8,7
Modular Belt Series 590 FG, H=8,7 / Modulare Mattenkette 590 FG, H=8,7

Imperial Size

CODE STRUCTURE GUIDE (Example)

Backflex radius min.: 25 mm

5302	01	0085	A
Series	*Material	Width	Version

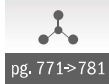

19.05 mm
PITCH

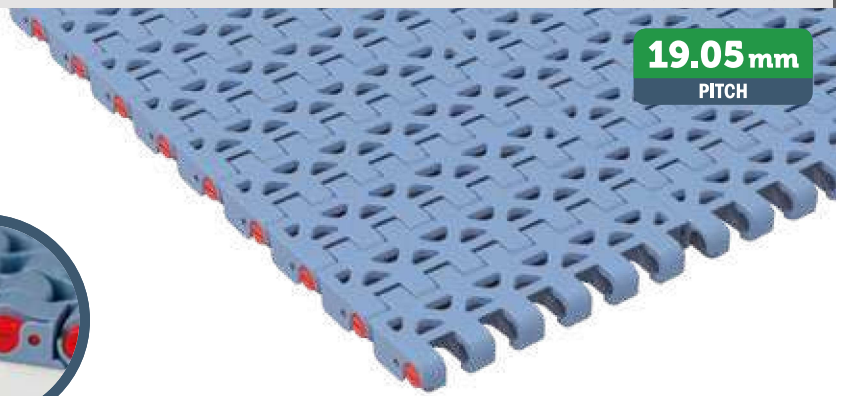
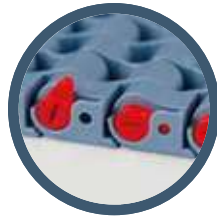

*Material

LFA - Code 01

Low friction Acetal

Easy Delivery

Max w. load: 30000 N/m
Weight: 6,5 kg/m²
Temp. range dry: -40+80 °C
Temp. range wet: -40+65 °C
Pin material: PBT white

MX - Code 03

Performance PBT

Max w. load: 24000 N/m
Weight: 6,0 kg/m²
Temp. range dry: -40+120 °C
Temp. range wet: -40+60 °C
Pin material: POM grey

LFB - Code 23

Low friction Acetal

Max w. load: 30000 N/m
Weight: 6,5 kg/m²
Temp. range dry: -40+80 °C
Temp. range wet: -40+65 °C
Pin material: PBT white

PFX - Code 30

Extra performance PBT

Max w. load: 24000 N/m
Weight: 6,0 kg/m²
Temp. range dry: -40+120 °C
Temp. range wet: -40+60 °C
Pin material: POM grey

**THE BEST CHOICE FOR
DRY RUNNING APPLICATIONS**

Version A - Standard

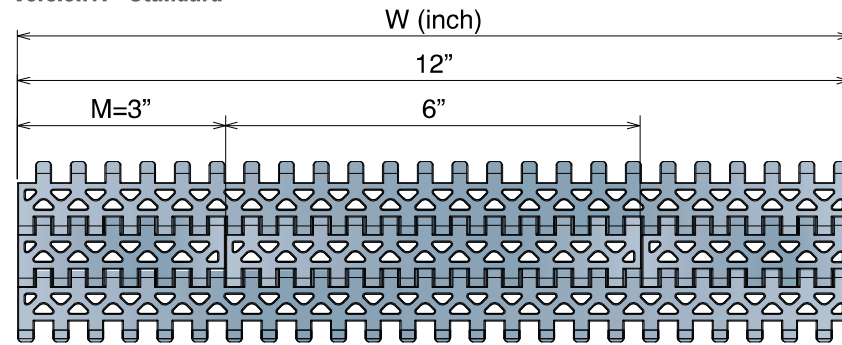

Version C - With 2 Positioner

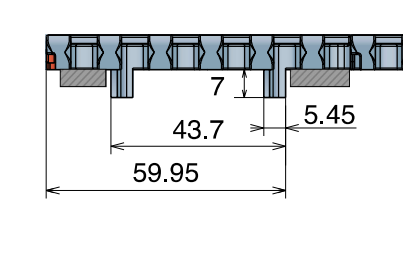

Version A - Standard

Series	Material	Width	Version
5302	*	0003	A
5302	*	0006	A
5302	*	0009	A
5302	*	0012	A
5302	*	0015	A
5302	*	0018	A
5302	*	0021	A
5302	*	0024	A
5302	*	0027	A
5302	*	0030	A
5302	*	0033	A
5302	*	0036	A
5302	*	0039	A
5302	*	0042	A
5302	*	0045	A
5302	*	0048	A
5302	*	0051	A
5302	*	0054	A

Version C - With 2 Positioners

Series	Material	Width	Version
5302	*	0003	C
5302	*	0006	C
5302	*	0009	C
5302	*	0012	C
5302	*	0015	C
5302	*	0018	C
5302	*	0021	C
5302	*	0024	C
5302	*	0027	C
5302	*	0030	C
5302	*	0033	C
5302	*	0036	C
5302	*	0039	C
5302	*	0042	C
5302	*	0045	C
5302	*	0048	C
5302	*	0051	C
5302	*	0054	C

NEW

590 FG One track Belt

Tappeto Modulare 590 FG, H=8,7
Modular Belt Series 590 FG, H=8,7 / Modulare Mattenkette 590 FG, H=8,7

CODE STRUCTURE GUIDE (Example)

Backflex radius min.: 25 mm

5302	01	9330	A
Series	*Material	Width	Version

19.05mm
PITCH

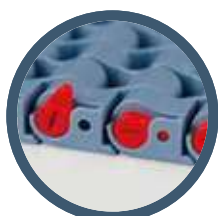
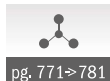

Imperial Size

*Material

LFA - Code 01

Low friction Acetal

Easy Delivery

Max w. load: 30000 N/m
Weight: 6,5 kg/m²
Temp. range dry: -40+80 °C
Temp. range wet: -40+65 °C
Pin material: PBT white

MX - Code 03

Performance PBT

Max w. load: 24000 N/m
Weight: 6,0 kg/m²
Temp. range dry: -40+120 °C
Temp. range wet: -40+60 °C
Pin material: POM grey

LFB - Code 23

Low friction Acetal

Max w. load: 30000 N/m
Weight: 6,5 kg/m²
Temp. range dry: -40+80 °C
Temp. range wet: -40+65 °C
Pin material: PBT white

PFX - Code 30

Extra performance PBT

Max w. load: 24000 N/m
Weight: 6,0 kg/m²
Temp. range dry: -40+120 °C
Temp. range wet: -40+60 °C
Pin material: POM grey

**THE BEST CHOICE FOR
DRY RUNNING APPLICATIONS**

Version A - Standard

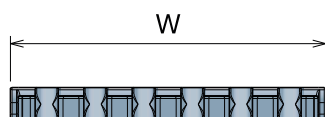

Version C - With 2 Positioner

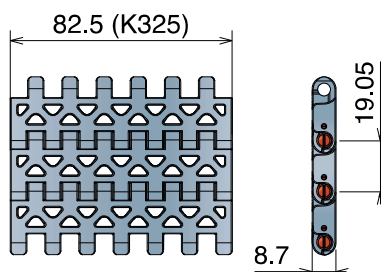
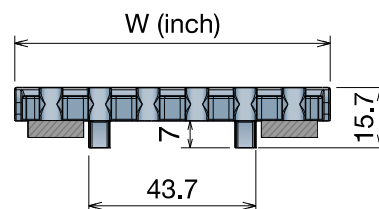

K325 - One track belt

Series	Material	Width	Version
5302	*	9325	A
5302	*	9325	C

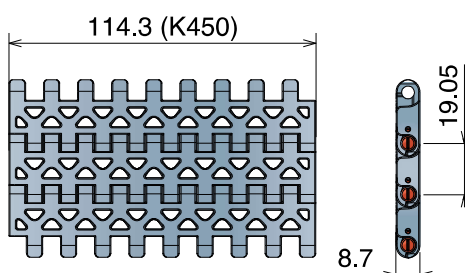

K450 - One track belt

Series	Material	Width	Version
5302	*	9450	A
5302	*	9450	C

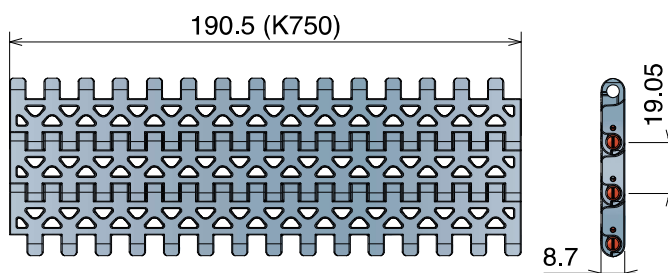

K750 - One track belt

Series	Material	Width	Version
5302	*	9750	A
5302	*	9750	C

525

Pitch 15,0 mm
H= 8,7 mm

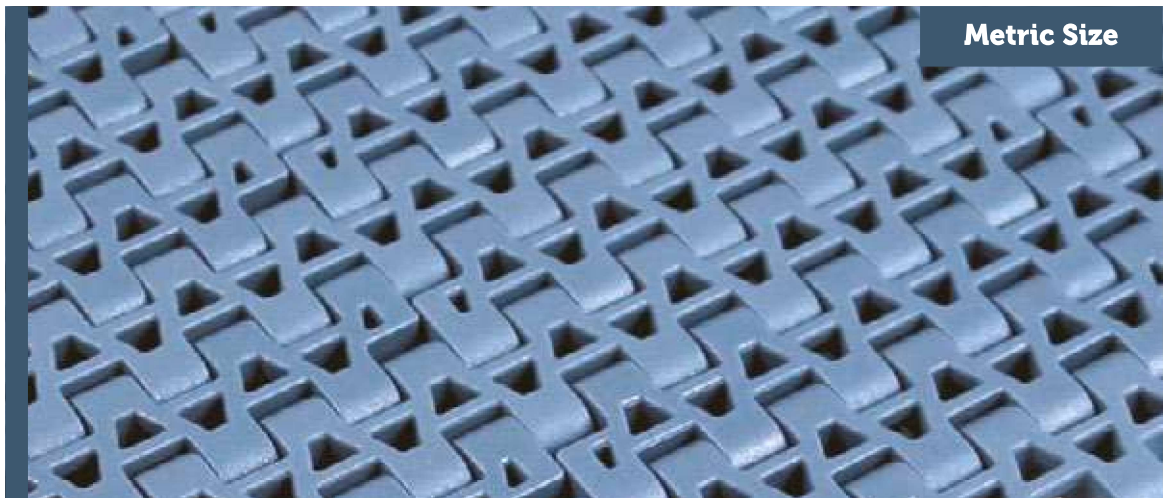

- 525 HD FT
- 525 HD FT+RIB
- 525 FTT
- 525 HD FG
- 525 HD GT
- 525 HD GT *Side Indent*

525 HD FT



Tappeto Modulare 525 HD, H=8,7 M=85
Modular Belt Series 525 HD, H=8,7 M=85 / Modulare Mattenkette 525 HD, H=8,7 M=85

Metric Size

CODE STRUCTURE GUIDE (Example)			
5261	01	0085	A
Series	*Material	Width	Version

Backflex radius min.: 25 mm

15.0 mm
PITCH

		
pg. 359-360	307/311/314	pg. 771>781

SAMPLE BOX	
Art.-Nr.	5261018388A



REINFORCED POSITIONER

*Material

LFA - Code 01

Low friction Acetal

Easy Delivery

Max w. load: 25500 N/m
Weight: 9,0 kg/m²
Temp. range dry: -40÷80 °C
Temp. range wet: -40÷65 °C
Pin material: PBT white

PP - Code 02

Polypropylene

Max w. load: 15500 N/m
Weight: 8,7 kg/m²
Temp. range dry: 4÷104 °C
Temp. range wet: 4÷104 °C
Pin material: PP blue

MX - Code 03

Performance PBT

Max w. load: 20500 N/m
Weight: 8,7 kg/m²
Temp. range dry: -40÷120 °C
Temp. range wet: -40÷60 °C
Pin material: POM grey

LFB - Code 23

Low friction Acetal

Max w. load: 25500 N/m
Weight: 9,0 kg/m²
Temp. range dry: -40÷80 °C
Temp. range wet: -40÷65 °C
Pin material: PBT white

PFX - Code 30

Extra performance PBT

Max w. load: 20500 N/m
Weight: 8,7 kg/m²
Temp. range dry: -40÷120 °C
Temp. range wet: -40÷60 °C
Pin material: POM grey

**THE BEST CHOICE FOR
DRY RUNNING APPLICATIONS**

Version A - Standard

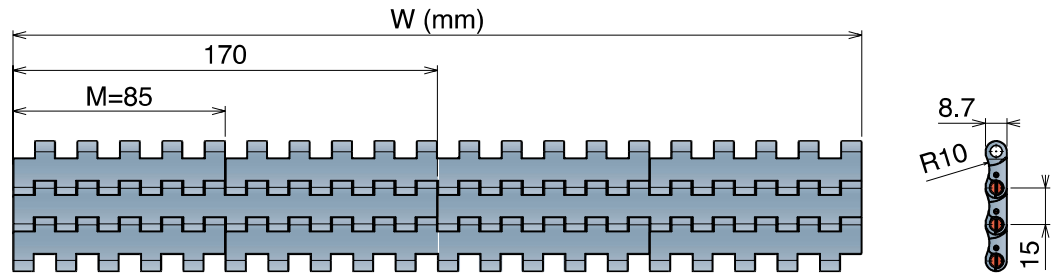

Version B - With 1 Positioner

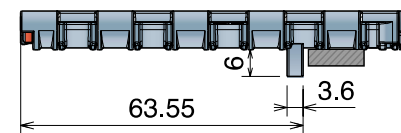

Version C - With 2 Positioner

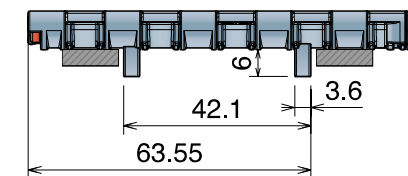

Version A - Standard

Series	Material	Width	Version
5261	*	0085	A
5261	*	0170	A
5261	*	0255	A
5261	*	0340	A
5261	*	0425	A
5261	*	0510	A
5261	*	0595	A
5261	*	0680	A
5261	*	0765	A
5261	*	0850	A
5261	*	0935	A
5261	*	1020	A
5261	*	1105	A
5261	*	1190	A
5261	*	1275	A
5261	*	1360	A
5261	*	1445	A
5261	*	1530	A

Version B - With 1 Positioner

Series	Material	Width	Version
5261	*	0085	B
5261	*	0170	B
5261	*	0255	B
5261	*	0340	B
5261	*	0425	B
5261	*	0510	B
5261	*	0595	B
5261	*	0680	B
5261	*	0765	B
5261	*	0850	B
5261	*	0935	B
5261	*	1020	B
5261	*	1105	B
5261	*	1190	B
5261	*	1275	B
5261	*	1360	B
5261	*	1445	B
5261	*	1530	B

Version C - With 2 Positioners

Series	Material	Width	Version
5261	*	0085	C
5261	*	0170	C
5261	*	0255	C
5261	*	0340	C
5261	*	0425	C
5261	*	0510	C
5261	*	0595	C
5261	*	0680	C
5261	*	0765	C
5261	*	0850	C
5261	*	0935	C
5261	*	1020	C
5261	*	1105	C
5261	*	1190	C
5261	*	1275	C
5261	*	1360	C
5261	*	1445	C
5261	*	1530	C

525 HD FT + RIB



Tappeto Modulare 525 HD, H=8,7 M=85

Modular Belt Series 525 HD, H=8,7 M=85 / Modulare Mattenkette 525 HD, H=8,7 M=85

CODE STRUCTURE GUIDE (Example)

Backflex radius min.: 25 mm

5261	01	0085	A	XR3
Series	*Material	Width	Version	RIB

		
pg. 359-360	307/311/314	pg. 771-781



15.0mm
PITCH

Metric Size

* Material

LFA - Code 01

Low friction Acetal

Max w. load: 25500 N/m
Weight: 9,0 kg/m²
Temp. range dry: -40+80 °C
Temp. range wet: -40+65 °C
Pin material: PBT white

MX - Code 03

Performance PBT

Max w. load: 20500 N/m
Weight: 8,7 kg/m²
Temp. range dry: -40+120 °C
Temp. range wet: -40+60 °C
Pin material: POM grey

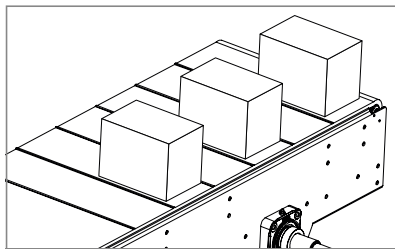

Special application in palletizer

Version A - Standard

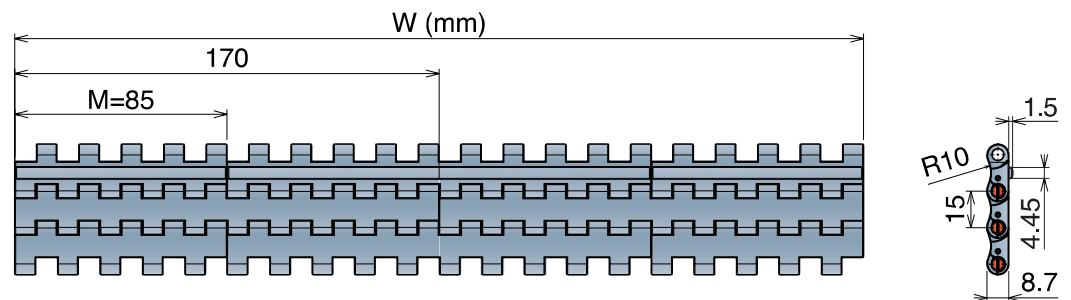

Version B - With 1 Positioner

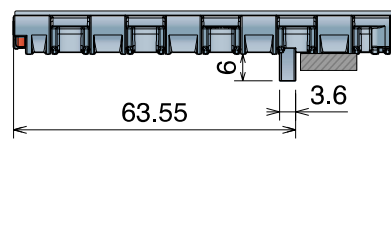

Version C - With 2 Positioners

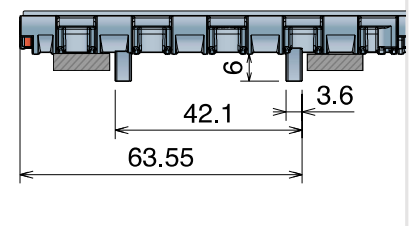

Version A - Standard

Series	Material	Width	Version	RIB
5261	*	0085	A	XR3 or XR5
5261	*	0170	A	XR3 or XR5
5261	*	0255	A	XR3 or XR5
5261	*	0340	A	XR3 or XR5
5261	*	0425	A	XR3 or XR5
5261	*	0510	A	XR3 or XR5
5261	*	0595	A	XR3 or XR5
5261	*	0680	A	XR3 or XR5
5261	*	0765	A	XR3 or XR5
5261	*	0850	A	XR3 or XR5
5261	*	0935	A	XR3 or XR5
5261	*	1020	A	XR3 or XR5
5261	*	1105	A	XR3 or XR5
5261	*	1190	A	XR3 or XR5
5261	*	1275	A	XR3 or XR5
5261	*	1360	A	XR3 or XR5
5261	*	1445	A	XR3 or XR5
5261	*	1530	A	XR3 or XR5

XR3 (RIB every 3 links) | XR5 (RIB every 5 links)

Version B - With 1 Positioner

Series	Material	Width	Version	RIB
5261	*	0085	B	XR3 or XR5
5261	*	0170	B	XR3 or XR5
5261	*	0255	B	XR3 or XR5
5261	*	0340	B	XR3 or XR5
5261	*	0425	B	XR3 or XR5
5261	*	0510	B	XR3 or XR5
5261	*	0595	B	XR3 or XR5
5261	*	0680	B	XR3 or XR5
5261	*	0765	B	XR3 or XR5
5261	*	0850	B	XR3 or XR5
5261	*	0935	B	XR3 or XR5
5261	*	1020	B	XR3 or XR5
5261	*	1105	B	XR3 or XR5
5261	*	1190	B	XR3 or XR5
5261	*	1275	B	XR3 or XR5
5261	*	1360	B	XR3 or XR5
5261	*	1445	B	XR3 or XR5
5261	*	1530	B	XR3 or XR5

XR3 (RIB every 3 links) | XR5 (RIB every 5 links)

Version C - With 2 Positioners

Series	Material	Width	Version	RIB
5261	*	0085	C	XR3 or XR5
5261	*	0170	C	XR3 or XR5
5261	*	0255	C	XR3 or XR5
5261	*	0340	C	XR3 or XR5
5261	*	0425	C	XR3 or XR5
5261	*	0510	C	XR3 or XR5
5261	*	0595	C	XR3 or XR5
5261	*	0680	C	XR3 or XR5
5261	*	0765	C	XR3 or XR5
5261	*	0850	C	XR3 or XR5
5261	*	0935	C	XR3 or XR5
5261	*	1020	C	XR3 or XR5
5261	*	1105	C	XR3 or XR5
5261	*	1190	C	XR3 or XR5
5261	*	1275	C	XR3 or XR5
5261	*	1360	C	XR3 or XR5
5261	*	1445	C	XR3 or XR5
5261	*	1530	C	XR3 or XR5

XR3 (RIB every 3 links) | XR5 (RIB every 5 links)

525 FTT

Tappeto Modulare 525 FTT, H=8,7 M=85
 Modular Belt Series 525 FTT, H=8,7 M=85 / Modulare Mattenkette 525 FTT, H=8,7 M=85

Metric Size

CODE STRUCTURE GUIDE (Example)			
5256	01	0085	C
Series	*Material	Width	Version

Backflex radius min.: 25 mm

15.0 mm
PITCH

pg. 359-360	307/311/314	pg. 771>781

*Material

LFA - Code 01	MX - Code 03
Low friction Acetal	Performance PBT

Max w. load: 21500 N/m	Max w. load: 17500 N/m
Weight: 7,8 kg/m ²	Weight: 7,5 kg/m ²
Temp. range dry: -40+80 °C	Temp. range dry: -40+120 °C
Temp. range wet: -40+65 °C	Temp. range wet: -40+60 °C
Pin material: PBT white	Pin material: POM grey

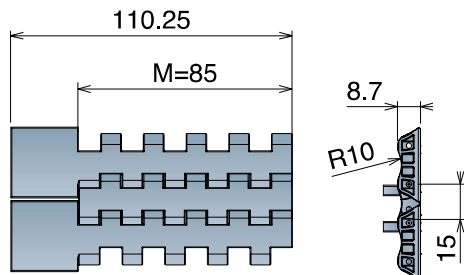

Version C

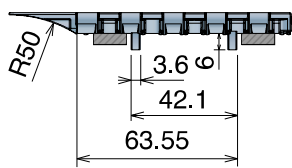

Version C

Series	Material	Width	Version
5256	*	0085	C

Max working load (N)

Width	85
LFA	1850
MX	1500

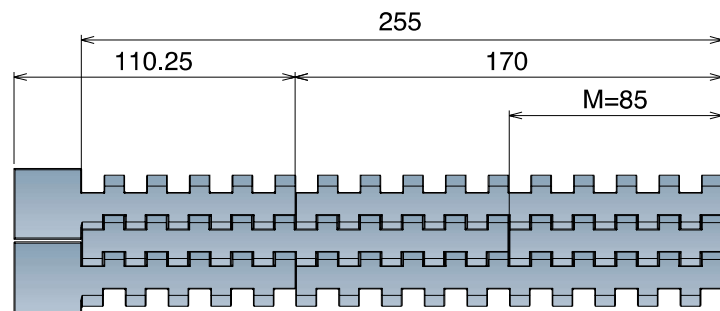

Version CN - Near

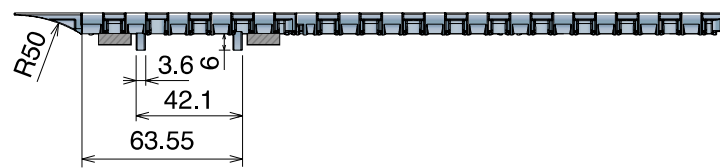

Version CO - Opposite



Version CN - Near

Series	Material	Width	Version
5256	*	0170	CN
5256	*	0255	CN

Version CO - Opposite



Series	Material	Width	Version
5256	*	0170	CO
5256	*	0255	CO

525 HD FG Open Surface 35% Tappeto Modulare 525 HD Flush grid, H=8,7 M=85 Modular Belt Series 525 HD Flush grid, H=8,7 M=85 / Modulare Mattenkette 525 HD Flush grid, H=8,7 M=85

CODE STRUCTURE GUIDE (Example)

Backflex radius min.: 25 mm

5262	01	0085	A
Series	*Material	Width	Version

		
pg. 359-360	307/311/314	pg. 771-781

SAMPLE BOX	
Art.-Nr.	5262018888A

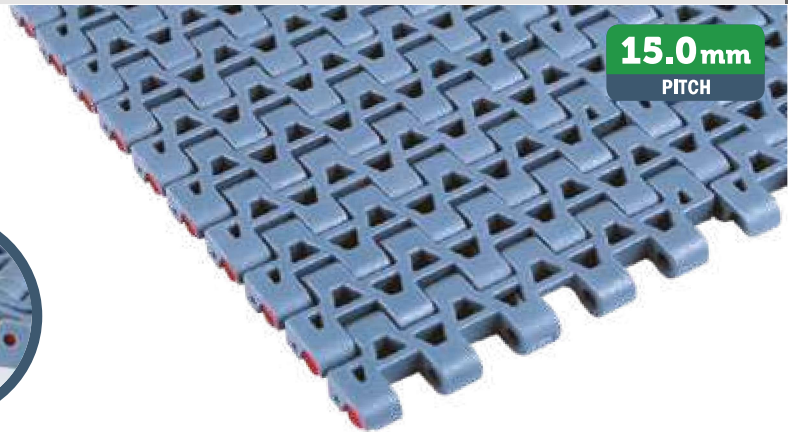

Metric Size

*Material

LFA - Code 01 Low friction Acetal

Easy Delivery

Max w. load: 25500 N/m
Weight: 8,1 kg/m²
Temp. range dry: -40+80 °C
Temp. range wet: -40+65 °C
Pin material: PBT white

MX - Code 03 Performance PBT

Max w. load: 20500 N/m
Weight: 7,8 kg/m²
Temp. range dry: -40+120 °C
Temp. range wet: -40+60 °C
Pin material: POM grey

LFB - Code 23 Low friction Acetal

Max w. load: 25500 N/m
Weight: 8,1 kg/m²
Temp. range dry: -40+80 °C
Temp. range wet: -40+65 °C
Pin material: PBT white

PFX - Code 30 Extra performance PBT

Max w. load: 20500 N/m
Weight: 7,8 kg/m²
Temp. range dry: -40+120 °C
Temp. range wet: -40+60 °C
Pin material: POM grey

**THE BEST CHOICE FOR
DRY RUNNING APPLICATIONS**

Version A - Standard

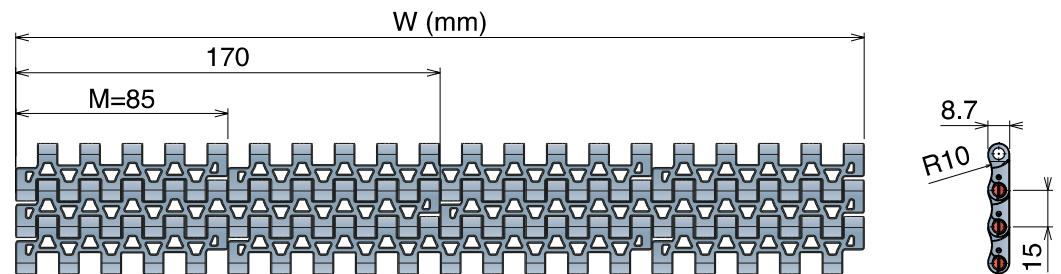

Version B - With 1 Positioner

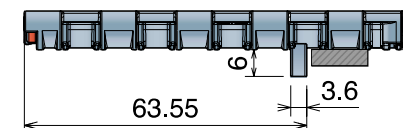

Version C - With 2 Positioners

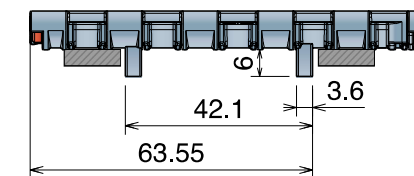

Version A - Standard

Series	Material	Width	Version
5262	*	0085	A
5262	*	0170	A
5262	*	0255	A
5262	*	0340	A
5262	*	0425	A
5262	*	0510	A
5262	*	0595	A
5262	*	0680	A
5262	*	0765	A
5262	*	0850	A
5262	*	0935	A
5262	*	1020	A
5262	*	1105	A
5262	*	1190	A
5262	*	1275	A
5262	*	1360	A
5262	*	1445	A
5262	*	1530	A

Version B - With 1 Positioner

Series	Material	Width	Version
5262	*	0085	B
5262	*	0170	B
5262	*	0255	B
5262	*	0340	B
5262	*	0425	B
5262	*	0510	B
5262	*	0595	B
5262	*	0680	B
5262	*	0765	B
5262	*	0850	B
5262	*	0935	B
5262	*	1020	B
5262	*	1105	B
5262	*	1190	B
5262	*	1275	B
5262	*	1360	B
5262	*	1445	B
5262	*	1530	B

Version C - With 2 Positioners

Series	Material	Width	Version
5262	*	0085	C
5262	*	0170	C
5262	*	0255	C
5262	*	0340	C
5262	*	0425	C
5262	*	0510	C
5262	*	0595	C
5262	*	0680	C
5262	*	0765	C
5262	*	0850	C
5262	*	0935	C
5262	*	1020	C
5262	*	1105	C
5262	*	1190	C
5262	*	1275	C
5262	*	1360	C
5262	*	1445	C
5262	*	1530	C

525 HD GT

Tappeto Modulare 525 HD GT, H=8,7 M=85
 Modular Belt Series 525 HD GT, H=8,7 M=85 / Modulare Mattenkette 525 HD GT, H=8,7 M=85

Metric Size

CODE STRUCTURE GUIDE (Example)			
5263	01	0085	A
Series	*Material	Width	Version

Backflex radius min.: 25 mm

pg. 359-360	307/311/314	pg. 771>781

SAMPLE BOX	
Art.-Nr.	5263018388A

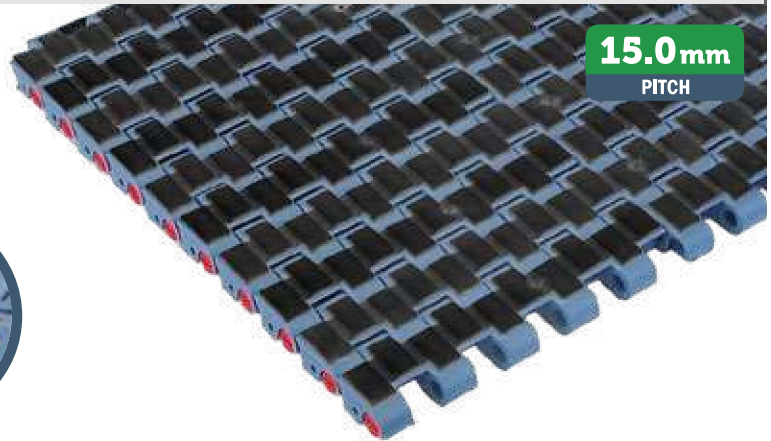

15.0 mm
PITCH

*Material

LFA - Code 01

Low friction Acetal

Easy Delivery

Max w. load: 25500 N/m
 Weight: 10,35 kg/m²
 Temp. range dry: -40÷80 °C
 Temp. range wet: -40÷65 °C
 Pin material: PBT white
 Top rubber: 50 ShA- Dark grey

PP - Code 02

Polypropylene

Max w. load: 15500 N/m
 Weight: 8,7 kg/m²
 Temp. range dry: 4÷80 °C
 Temp. range wet: 4÷80 °C
 Pin material: PP blue
 Top rubber: 50 ShA- Pigeon blue

MX - Code 03

Performance PBT

Max w. load: 20500 N/m
 Weight: 10,35 kg/m²
 Temp. range dry: -40÷120 °C
 Temp. range wet: -40÷60 °C
 Pin material: POM grey
 Top rubber: 50 ShA- Dark grey

Version A - Standard

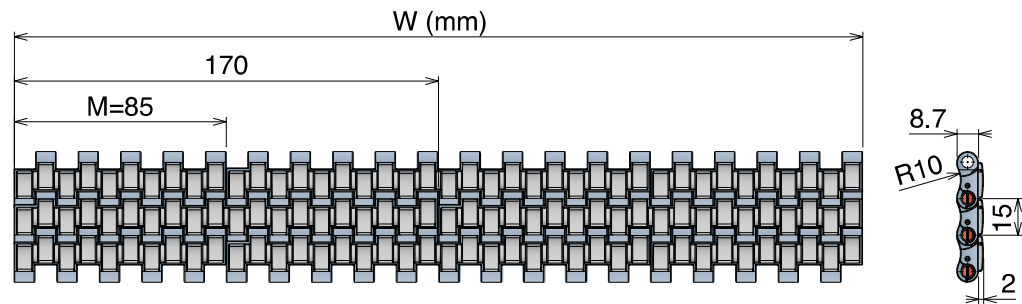

Version B - With 1 Positioner

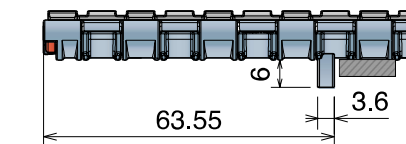

Version C - With 2 Positioners

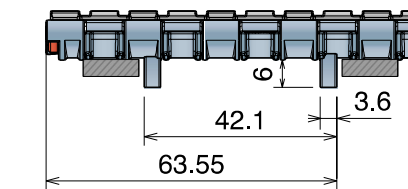

Version A - Standard

Series	Material	Width	Version
5263	*	0085	A
5263	*	0170	A
5263	*	0255	A
5263	*	0340	A
5263	*	0425	A
5263	*	0510	A
5263	*	0595	A
5263	*	0680	A
5263	*	0765	A
5263	*	0850	A
5263	*	0935	A
5263	*	1020	A
5263	*	1105	A
5263	*	1190	A
5263	*	1275	A
5263	*	1360	A
5263	*	1445	A
5263	*	1530	A

Version B - With 1 Positioner

Series	Material	Width	Version
5263	*	0085	B
5263	*	0170	B
5263	*	0255	B
5263	*	0340	B
5263	*	0425	B
5263	*	0510	B
5263	*	0595	B
5263	*	0680	B
5263	*	0765	B
5263	*	0850	B
5263	*	0935	B
5263	*	1020	B
5263	*	1105	B
5263	*	1190	B
5263	*	1275	B
5263	*	1360	B
5263	*	1445	B
5263	*	1530	B

Version C - With 2 Positioners

Series	Material	Width	Version
5263	*	0085	C
5263	*	0170	C
5263	*	0255	C
5263	*	0340	C
5263	*	0425	C
5263	*	0510	C
5263	*	0595	C
5263	*	0680	C
5263	*	0765	C
5263	*	0850	C
5263	*	0935	C
5263	*	1020	C
5263	*	1105	C
5263	*	1190	C
5263	*	1275	C
5263	*	1360	C
5263	*	1445	C
5263	*	1530	C

525 HD GT Side indent

Tappeti modulari / Modular belts / Mattenketten



Belts wider than standard are available with 85 mm increments

525 HD GT Side Indent Tappeto Modulare 525 HD GT Side Indent, H=8,7 M=85 Modular Belt Series 525 HD GT Side Indent, H=8,7 M=85 / Modulare Mattenkette 525 HD GT Side Indent, H=8,7 M=85

CODE STRUCTURE GUIDE (Example)

Backflex radius min.: 25 mm

5265	01	0255	A
Series	*Material	Width	Version

		
pg. 359-360	307/311/314	pg. 771-781

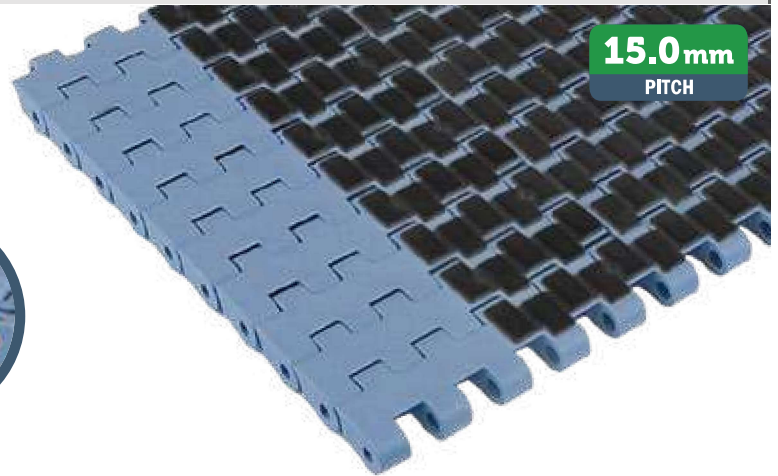

15.0mm
PITCH



Metric Size

*Material

LFA - Code 01

Low friction Acetal

Easy Delivery

Max w. load: 25500 N/m
Weight: 10,35 kg/m²
Temp. range dry: -40+80 °C
Temp. range wet: -40+65 °C
Pin material: PBT white
Top rubber: 50 ShA- Dark grey

PP - Code 02

Polypropylene

Max w. load: 15500 N/m
Weight: 8,7 kg/m²
Temp. range dry: 4+80 °C
Temp. range wet: 4+80 °C
Pin material: PP blue
Top rubber: 50 ShA- Pigeon blue

MX - Code 03

Performance PBT

Max w. load: 20500 N/m
Weight: 10,35 kg/m²
Temp. range dry: -40+120 °C
Temp. range wet: -40+60 °C
Pin material: POM grey
Top rubber: 50 ShA- Dark grey

Version A - Standard

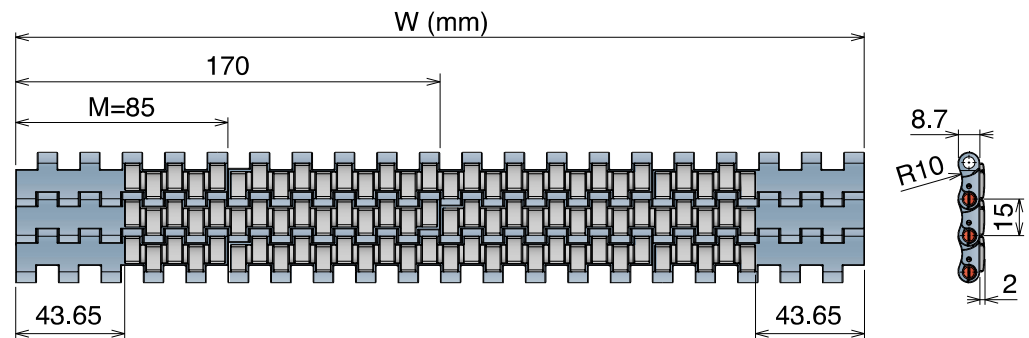

Version B - With 1 Positioner

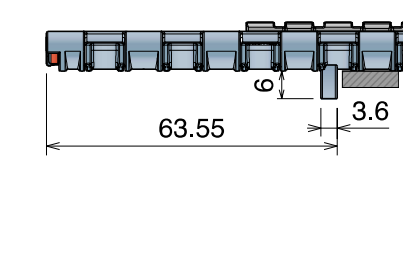

Version C - With 2 Positioner

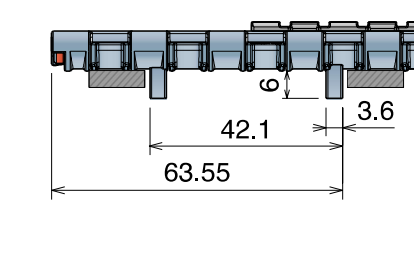

Version A - Standard

Series	Material	Width	Version
5265	*	0255	A
5265	*	0340	A
5265	*	0425	A
5265	*	0510	A
5265	*	0595	A
5265	*	0680	A
5265	*	0765	A
5265	*	0850	A
5265	*	0935	A
5265	*	1020	A
5265	*	1105	A
5265	*	1190	A
5265	*	1275	A
5265	*	1360	A
5265	*	1445	A
5265	*	1530	A

Version B - With 1 Positioner

Series	Material	Width	Version
5265	*	0255	B
5265	*	0340	B
5265	*	0425	B
5265	*	0510	B
5265	*	0595	B
5265	*	0680	B
5265	*	0765	B
5265	*	0850	B
5265	*	0935	B
5265	*	1020	B
5265	*	1105	B
5265	*	1190	B
5265	*	1275	B
5265	*	1360	B
5265	*	1445	B
5265	*	1530	B

Version C - With 2 Positioners

Series	Material	Width	Version
5265	*	0255	C
5265	*	0340	C
5265	*	0425	C
5265	*	0510	C
5265	*	0595	C
5265	*	0680	C
5265	*	0765	C
5265	*	0850	C
5265	*	0935	C
5265	*	1020	C
5265	*	1105	C
5265	*	1190	C
5265	*	1275	C
5265	*	1360	C
5265	*	1445	C
5265	*	1530	C

530 Series

530

Pitch 15,0 mm
H= 8,7 mm



530 FT

530 FT *One track Belt*

530 FTT

530 GT

530 GT *Side indent*

530 LBP

530 PRO LBP

Movex[®]

530 FT



Tappeto Modulare 530 FT, H=8,7 M=3"
Modular Belt Series 530 FT, H=8,7 M=3" / Modulare Mattenkette 530 FT, H=8,7 M=3"

CODE STRUCTURE GUIDE (Example)

Backflex radius min.: 25 mm

5321	01	0003	A
Series	*Material	Width	Version

15.0mm
PITCH

		
pg. 359-360	309/312/315	pg. 771-781

SAMPLE BOX

Art.-Nr. **5321018888A**



Version A - Standard

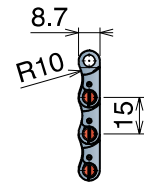
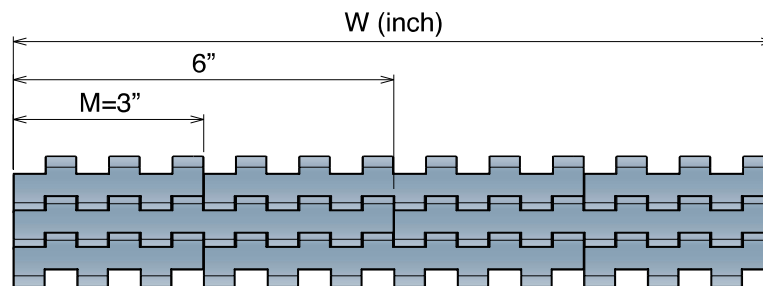

*Material

LFA - Code 01

Low friction Acetal

Easy Delivery

Max w. load: 26000 N/m
Weight: 9,2 kg/m²
Temp. range dry: -40+80 °C
Temp. range wet: -40+65 °C
Pin material: PBT white

MX - Code 03

Performance PBT

Max w. load: 21000 N/m
Weight: 9,0 kg/m²
Temp. range dry: -40+120 °C
Temp. range wet: -40+60 °C
Pin material: POM grey

DKM - Code 16

Aramide Reinforced Acetal

Max w. load: 26000 N/m
Weight: 9,2 kg/m²
Temp. range dry: -40+80 °C
Temp. range wet: -40+65 °C
Pin material: PBT white

MWX - Code 17

Polyamide Composite

Max w. load: 26000 N/m
Weight: 9,5 kg/m²
Temp. range dry: -40+104 °C
Temp. range wet: NR
Pin material: PBT white

MPX - Code 25

Lubricated Acetal

Max w. load: 26000 N/m
Weight: 9,2 kg/m²
Temp. range dry: -40+80 °C
Temp. range wet: -40+65 °C
Pin material: PBT white

Version A - Standard

Series	Material	Width	Version
5321	*	0003	A
5321	*	0006	A
5321	*	0009	A
5321	*	0012	A
5321	*	0015	A
5321	*	0018	A
5321	*	0021	A
5321	*	0024	A
5321	*	0027	A
5321	*	0030	A
5321	*	0033	A
5321	*	0036	A
5321	*	0039	A
5321	*	0042	A
5321	*	0045	A
5321	*	0048	A
5321	*	0051	A
5321	*	0054	A

530 FT One track Belt



Tappeto Modulare 530 FT, H=8,7 M=3"
Modular Belt Series 530 FT, H=8,7 M=3" / Modulare Mattenkette 530 FT, H=8,7 M=3"

CODE STRUCTURE GUIDE (Example)

Backflex radius min.: 10 mm

5321	01	9450	A
Series	*Material	Width	Version

15.0mm
PITCH

		
pg. 359-360	309/312/315	pg. 771>781



Imperial Size

***Material**

LFA - Code 01

Low friction Acetal

Easy Delivery

Max w. load: 3000 N
Weight: 9,2 kg/m²
Temp. range dry: -40+80 °C
Temp. range wet: -40+65 °C
Pin material: PBT white

MX - Code 03

Performance PBT

Max w. load: 2400 N
Weight: 9,0 kg/m²
Temp. range dry: -40+120 °C
Temp. range wet: -40+60 °C
Pin material: POM grey

DKM - Code 16

Aramide Reinforced Acetal

Max w. load: 3000 N
Weight: 9,2 kg/m²
Temp. range dry: -40+80 °C
Temp. range wet: -40+65 °C
Pin material: PBT white

MWX - Code 17

Polyamide Composite

Max w. load: 3000 N
Weight: 9,5 kg/m²
Temp. range dry: -40+104 °C
Temp. range wet: NR
Pin material: PBT white

MPX - Code 25

Lubricated Acetal

Max w. load: 3000 N
Weight: 9,2 kg/m²
Temp. range dry: -40+80 °C
Temp. range wet: -40+65 °C
Pin material: PBT white

K450

Version A - Standard

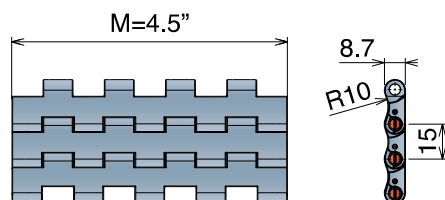

Version A - Standard

Series	Material	Width	Version
5321	*	9450	A

530 FTT

Tappeto Modulare 530 FTT, H=8,7 M=3"
 Modular Belt Series 530 FTT, H=8,7 M=3" / Modulare Mattenkette 530 FTT, H=8,7 M=3"

CODE STRUCTURE GUIDE (Example)

Backflex radius min.: 25 mm

5326	01	0003	A
Series	*Material	Width	Version

15.0mm
PITCH

pg. 359-360	309/312/315	pg. 771->781



***Material**

LFA - Code 01

Low friction Acetal

Max w. load: 26000 N/m
 Weight: 9,2 kg/m²
 Temp. range dry: -40+80 °C
 Temp. range wet: -40+65 °C
 Pin material: PBT white

MX - Code 03

Performance PBT

Max w. load: 21000 N/m
 Weight: 9,0 kg/m²
 Temp. range dry: -40+120 °C
 Temp. range wet: -40+60 °C
 Pin material: POM grey

Version A - Standard

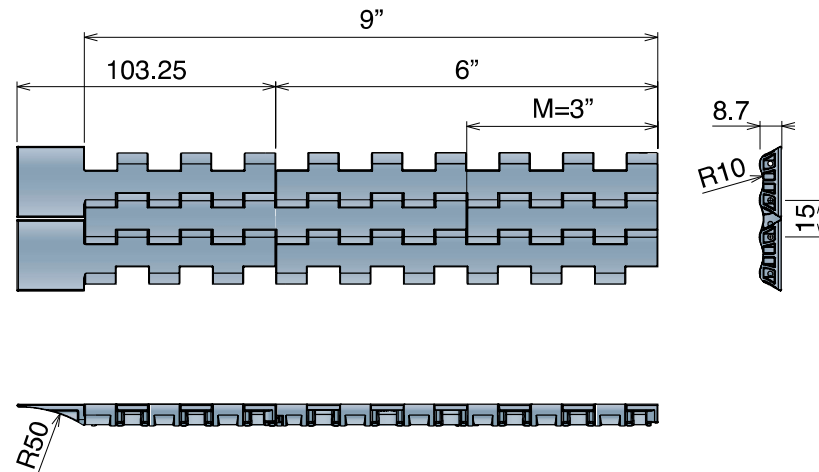

Version A - Standard

Series	Material	Width	Version
5326	*	0003	A
5326	*	0006	A
5326	*	0009	A



530 GT



Tappeto Modulare 530 GT, H=8,7 M=3"
 Modular Belt Series 530 GT, H=8,7 M=3" / Modulare Mattenkette 530 GT, H=8,7 M=3"

CODE STRUCTURE GUIDE (Example)

Backflex radius min.: 30 mm

5323	01	0003	A
Series	*Material	Width	Version

15.0mm
PITCH

		
pg. 359-360	309/312/315	pg. 771>781

SAMPLE BOX

Art.-Nr. **5323018888A**

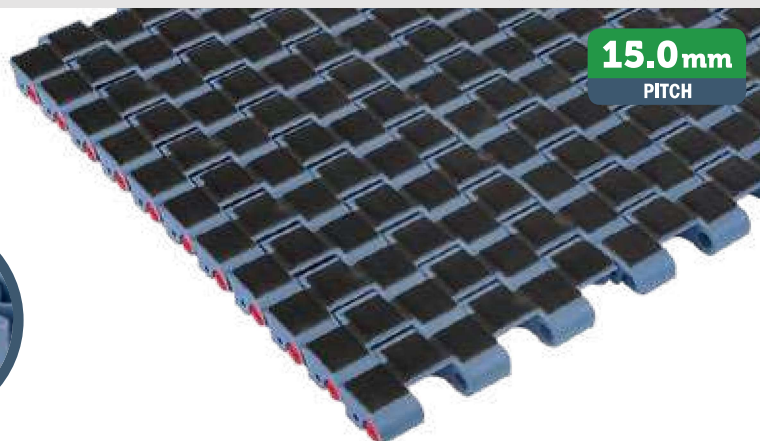

Imperial Size

*Material

LFA - Code 01

Low friction Acetal

Easy Delivery

Max w. load: 26000 N/m
 Weight: 10,6 kg/m²
 Temp. range dry: -40÷80 °C
 Temp. range wet: -40÷65 °C
 Pin material: PBT white
 Top rubber: 50 ShA-Pigeon blue

PP - Code 02

Polypropylene

Max w. load: 16000 N/m
 Weight: 9,0 kg/m²
 Temp. range dry: 4÷80 °C
 Temp. range wet: 4÷80 °C
 Pin material: PP blue
 Top rubber: 50 ShA-Pigeon blue

MX - Code 03

Performance PBT

Max w. load: 21000 N/m
 Weight: 10,6 kg/m²
 Temp. range dry: -40÷120 °C
 Temp. range wet: -40÷60 °C
 Pin material: POM grey
 Top rubber: 50 ShA-Dark grey

Version A - Standard

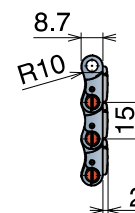
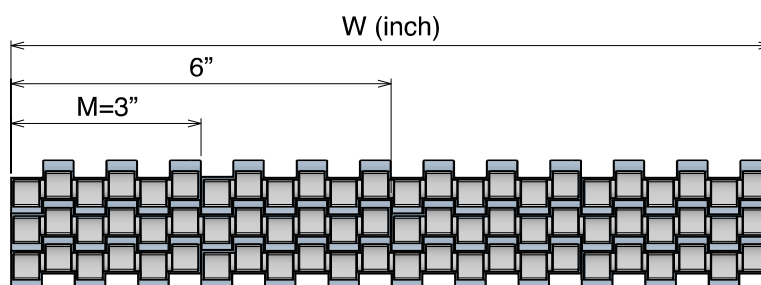

Version A - Standard

Series	Material	Width	Version
5323	*	0003	A
5323	*	0006	A
5323	*	0009	A
5323	*	0012	A
5323	*	0015	A
5323	*	0018	A
5323	*	0021	A
5323	*	0024	A
5323	*	0027	A
5323	*	0030	A
5323	*	0033	A
5323	*	0036	A
5323	*	0039	A
5323	*	0042	A
5323	*	0045	A
5323	*	0048	A
5323	*	0051	A
5323	*	0054	A

530 GT Side indent

Tappeti modulari / Modular belts / Mattenketten



Belts wider than standard are available with 3 inch increments

530 GT Side indent Tappeto Modulare 530 GT, H=8,7 M=3" Modular Belt Series 530 GT, H=8,7 M=3" / Modulare Mattenkette 530 GT, H=8,7 M=3"

CODE STRUCTURE GUIDE (Example)

Backflex radius min.: 30 mm

5325	01	0009	A
Series	*Material	Width	Version

		
pg. 359-360	309/312/315	pg. 771-781

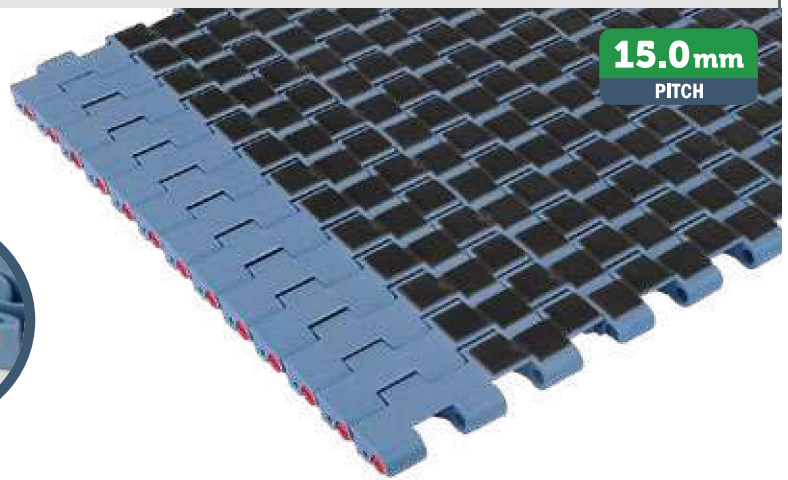

Imperial Size

*Material

LFA - Code 01

Low friction Acetal

Easy Delivery

Max w. load: 26000 N/m
Weight: 10,6 kg/m²
Temp. range dry: -40+80 °C
Temp. range wet: -40+65 °C
Pin material: PBT white
Top rubber: 50 ShA-Dark grey

PP - Code 02

Polypropylene

Max w. load: 16000 N/m
Weight: 9,0 kg/m²
Temp. range dry: 4+80 °C
Temp. range wet: 4+80 °C
Pin material: PP blue
Top rubber: 50 ShA-Pigeon blue

MX - Code 03

Performance PBT

Max w. load: 21000 N/m
Weight: 10,6 kg/m²
Temp. range dry: -40+120 °C
Temp. range wet: -40+60 °C
Pin material: POM grey
Top rubber: 50 ShA-Dark grey

Version A - Standard

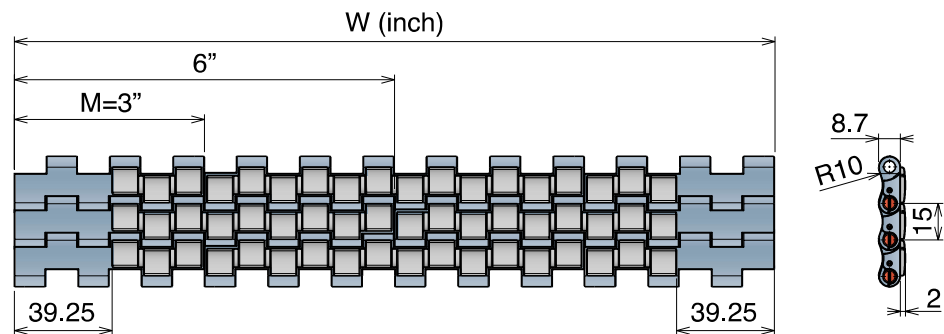

Version A - Standard

Series	Material	Width	Version
5325	*	0009	A
5325	*	0012	A
5325	*	0015	A
5325	*	0018	A
5325	*	0021	A
5325	*	0024	A
5325	*	0027	A
5325	*	0030	A
5325	*	0033	A
5325	*	0036	A
5325	*	0039	A
5325	*	0042	A
5325	*	0045	A
5325	*	0048	A
5325	*	0051	A
5325	*	0054	A

Tappeti modulari / Modular belts / Mattenketten

530 LBP

Tappeto Modulare 530 LBP, H=8,7 M=3"
 Modular Belt Series 530 LBP, H=8,7 M=3" / Modulare Mattenkette 530 LBP, H=8,7 M=3"

Imperial Size

CODE STRUCTURE GUIDE (Example)

Backflex radius min.: 25 mm

5324	01	0006	A
Series	*Material	Width	Version

15.0mm
PITCH

pg. 359-360	pg. 309/313	pg. 771>781

SAMPLE BOX	
Art.-Nr.	5324018888A

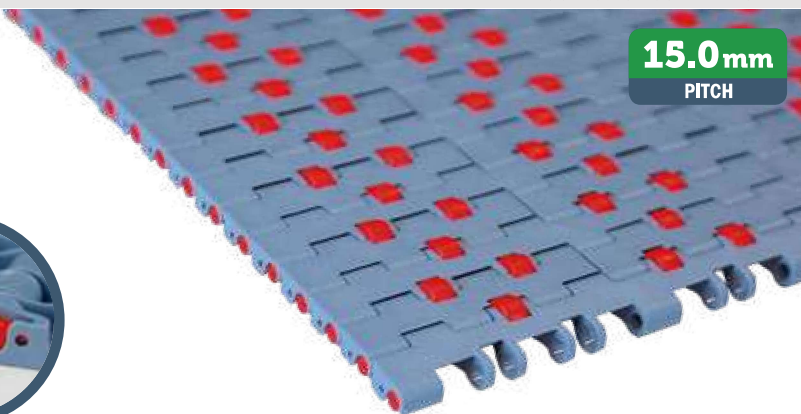

Material

LFA - Code 01

Low friction Acetal

Max w. load: 24000 N/m
 Weight: 9,0 kg/m²
 Temp. range dry: -40÷80 °C
 Temp. range dry: -40÷65 °C
 Pin material: PBT white

POM Roller

Density: 700 rollers/m²

Version A - Standard

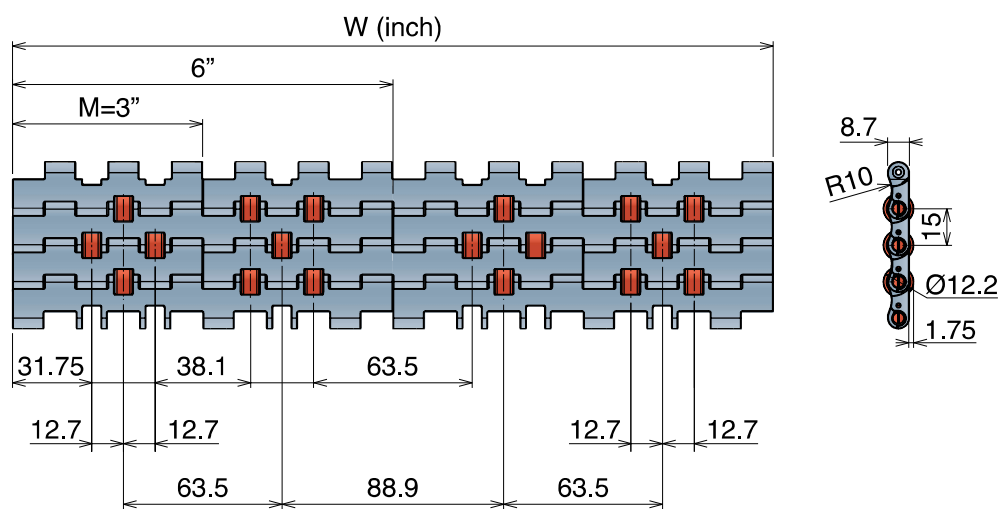

Version A - Standard

Series	Material	Width	Version
5324	01	0006	A
5324	01	0012	A
5324	01	0018	A
5324	01	0024	A
5324	01	0030	A
5324	01	0036	A
5324	01	0042	A
5324	01	0048	A
5324	01	0054	A

Guide position for accumulation system - Example

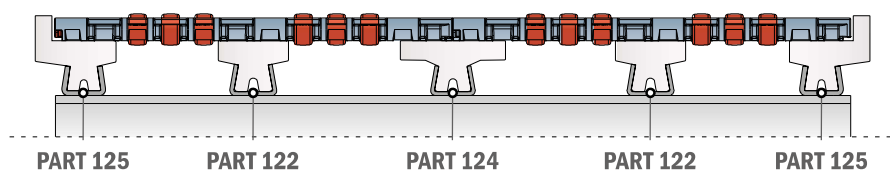

For accumulation system, please place the wear strips between the rollers (max 50 mm).

Guide position for driven rollers, for alignment/distribution system - Example

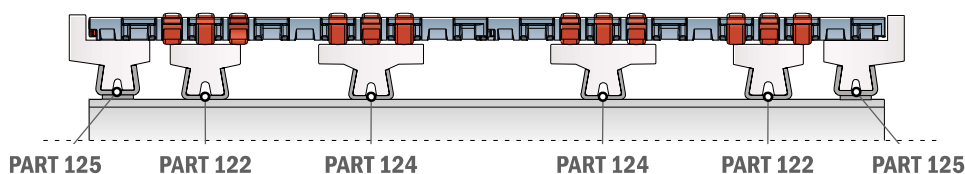

For driven rollers, please place the wear strips directly in contact under the rollers.

530 LBP can also be used with standard profiles: consult extruded profiles section for more details.

530 PRO LBP

Tappeto Modulare 530 PRO LBP, H=8,7 M=3"
Modular Belt Series 530 PRO LBP, H=8,7 M=3" / Modulare Mattenkette 530 PRO LBP, H=8,7 M=3"

CODE STRUCTURE GUIDE (Example)

Backflex radius min.: 25 mm

5237	01	0006	A
Series	*Material	Width	Version

15.0mm
PITCH



NoseBars



pg. 359-360

pg. 310/313

pg. 771-781

SAMPLE BOX

Art.-Nr. **523701888A**



Pin Sphere[®]
AUTOLOCK

- Easier installation
- Quicker maintenance
- High strength

Material

LFA - Code 01

Low friction Acetal

Max w. load: 21000 N/m
Weight: 10,0 kg/m²
Temp. range dry: -40÷80 °C
Temp. range wet: -40÷65 °C
Pin material: PBT white

PFX Roller

Density: 3.400 rollers/m²

**THE BEST CHOICE TO REACH
THE LOWEST FRICTION**

Version A - Standard

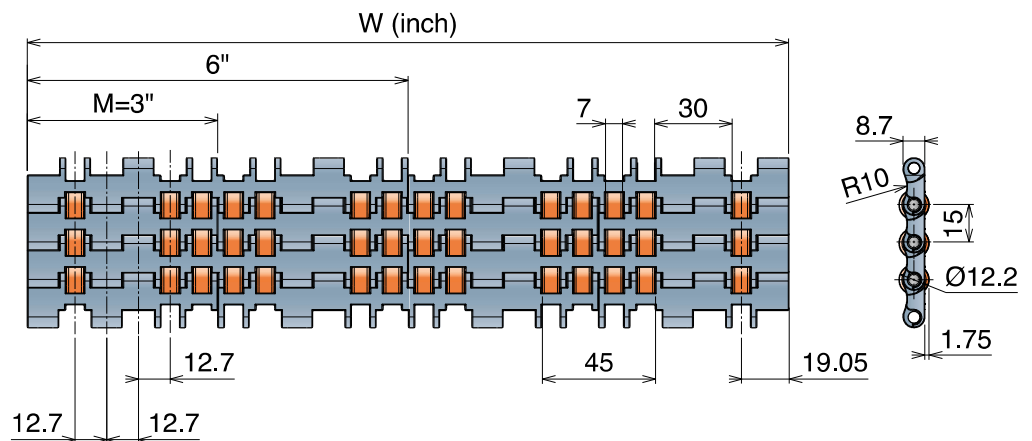

Guide position for accumulation system - Example

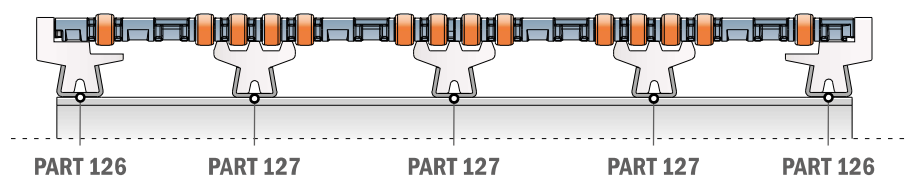

For accumulation system, please place the wear strips between the rollers (max 25 mm).

Guide position for driven rollers, for alignment/distribution system - Example

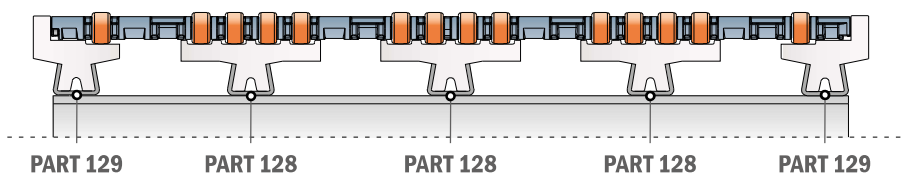

For driven rollers, please place the wear strips directly in contact under the rollers.

530 PRO LBP can also be used with standard profiles: consult extruded profiles section for more details.

Version A - Standard

Series	Material	Width	Version
5237	01	0006	A
5237	01	0009	A
5237	01	0012	A
5237	01	0015	A
5237	01	0018	A
5237	01	0021	A
5237	01	0024	A
5237	01	0027	A
5237	01	0030	A
5237	01	0033	A
5237	01	0036	A
5237	01	0039	A
5237	01	0042	A
5237	01	0045	A
5237	01	0048	A
5237	01	0051	A
5237	01	0054	A

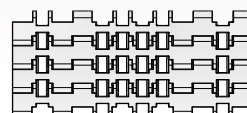

Rollers configuration for
530 PRO LBP,
6 inch wide belt.

550

Pitch 25,4 mm

H= 8,7 mm



Metric Size

550 FT

550 FT *One track Belt*

550 FTT

550 UTS

550 UTS *One track Belt*

550 GT

550 GT *Side indent*

550 FLIGHT TOP

550 V

550 V *One track Belt*

550 PRO FT

550 PRO M

550 FT

Tappeto Modulare 550 FT, H=8,7 M=85
Modular Belt Series 550 FT, H=8,7 M=85 / Modulare Mattenkette 550 FT, H=8,7 M=85

CODE STRUCTURE GUIDE (Example)

Backflex radius min.: 25 mm

5501	01	0085	A
Series	*Material	Width	Version

25.4mm
PITCH

Metric Size

*Material

LFA - Code 01

Low friction Acetal

Easy Delivery

Max w. load: 30000 N/m
Weight: 8,5 kg/m²
Temp. range dry: -40÷80 °C
Temp. range wet: -40÷65 °C
Pin material: PBT white

PP - Code 02

Polypropylene

Max w. load: 18000 N/m
Weight: 8,4 kg/m²
Temp. range dry: 4÷104 °C
Temp. range wet: 4÷104 °C
Pin material: PP blue

MX - Code 03

Performance PBT

Max w. load: 24000 N/m
Weight: 8,2 kg/m²
Temp. range dry: -40÷120 °C
Temp. range wet: -40÷60 °C
Pin material: POM grey

LFW - Code 05

Low friction Acetal

Max w. load: 30000 N/m
Weight: 8,5 kg/m²
Temp. range dry: -40÷80 °C
Temp. range wet: -40÷65 °C
Pin material: PBT white

DKM - Code 16

Aramide Reinforced Acetal

Max w. load: 30000 N/m
Weight: 8,5 kg/m²
Temp. range dry: -40÷80 °C
Temp. range wet: -40÷65 °C
Pin material: PBT white

MWX - Code 17

Polyamide Composite

Max w. load: 30000 N/m
Weight: 8,9 kg/m²
Temp. range dry: -40÷104 °C
Temp. range wet: NR
Pin material: PBT white

LFB - Code 23

Low friction Acetal

Max w. load: 30000 N/m
Weight: 8,5 kg/m²
Temp. range dry: -40÷80 °C
Temp. range wet: -40÷65 °C
Pin material: PBT white

PFX - Code 30

Extra performance PBT

Max w. load: 24000 N/m
Weight: 8,2 kg/m²
Temp. range dry: -40÷120 °C
Temp. range wet: -40÷60 °C
Pin material: POM grey



- Easier installation
- Quicker maintenance
- 100% interchangeable



pg. 362/363



pg. 771>781

SAMPLE BOX

Art.-Nr. **5501018888A**

Version A - Standard

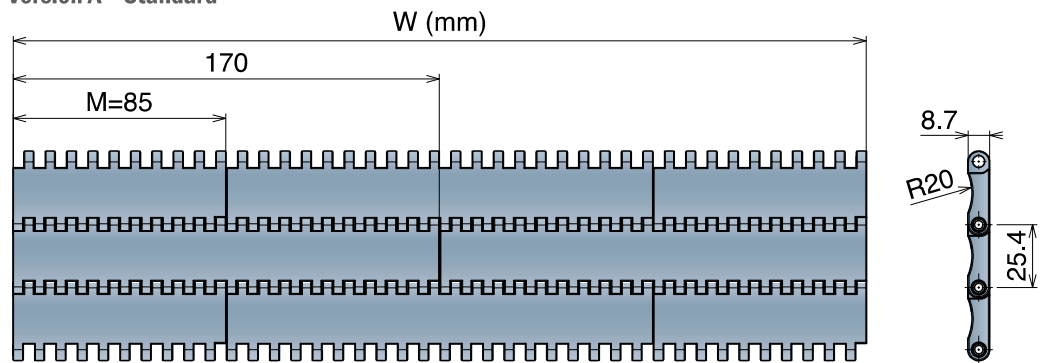

Version B - With 1 Positioner

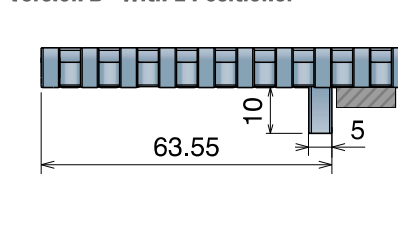

Version C - With 2 Positioner

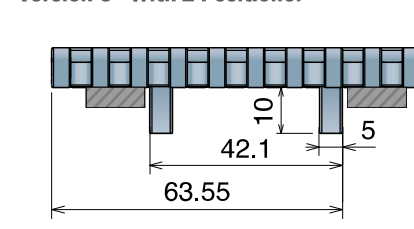

Version A - Standard

Series	Material	Width	Version
5501	*	0085	A
5501	*	0170	A
5501	*	0255	A
5501	*	0340	A
5501	*	0425	A
5501	*	0510	A
5501	*	0595	A
5501	*	0680	A
5501	*	0765	A
5501	*	0850	A
5501	*	0935	A
5501	*	1020	A
5501	*	1105	A
5501	*	1190	A
5501	*	1275	A
5501	*	1360	A
5501	*	1445	A
5501	*	1530	A

Version B - With 1 Positioner

Series	Material	Width	Version
5501	*	0085	B
5501	*	0170	B
5501	*	0255	B
5501	*	0340	B
5501	*	0425	B
5501	*	0510	B
5501	*	0595	B
5501	*	0680	B
5501	*	0765	B
5501	*	0850	B
5501	*	0935	B
5501	*	1020	B
5501	*	1105	B
5501	*	1190	B
5501	*	1275	B
5501	*	1360	B
5501	*	1445	B
5501	*	1530	B

Version C - With 2 Positioners

Series	Material	Width	Version
5501	*	0085	C
5501	*	0170	C
5501	*	0255	C
5501	*	0340	C
5501	*	0425	C
5501	*	0510	C
5501	*	0595	C
5501	*	0680	C
5501	*	0765	C
5501	*	0850	C
5501	*	0935	C
5501	*	1020	C
5501	*	1105	C
5501	*	1190	C
5501	*	1275	C
5501	*	1360	C
5501	*	1445	C
5501	*	1530	C

550 FT One track Belt

Tappeto Modulare 550 FT, H=8,7 K330
Modular Belt Series 550 FT, H=8,7 K330 / Modulare Mattenkette 550 FT, H=8,7 K330

CODE STRUCTURE GUIDE (Example)

Backflex radius min.: 25 mm

5221	01	9330	A
Series	*Material	Width	Version

25.4mm
PITCH

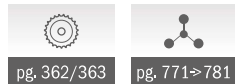

pg. 362/363 | pg. 771>781

*Material

LFA - Code 01

Low friction Acetal

Easy Delivery

Max w. load: 2500 N
Weight: 8,5 kg/m²
Temp. range dry: -40+80 °C
Temp. range wet: -40+65 °C
Pin material: PBT white

PP - Code 02

Polypropylene

Max w. load: 1500 N
Weight: 8,4 kg/m²
Temp. range dry: 4+104 °C
Temp. range wet: 4+104 °C
Pin material: PP blue

MX - Code 03

Performance PBT

Max w. load: 2000 N
Weight: 8,2 kg/m²
Temp. range dry: -40+120 °C
Temp. range wet: -40+60 °C
Pin material: POM grey

DKM - Code 16

Aramide Reinforced Acetal

Max w. load: 2500 N
Weight: 8,5 kg/m²
Temp. range dry: -40+80 °C
Temp. range wet: -40+65 °C
Pin material: PBT white

MWX - Code 17

Polyamide Composite

Max w. load: 2500 N
Weight: 8,9 kg/m²
Temp. range dry: -40+104 °C
Temp. range wet: NR
Pin material: PBT white

LFB - Code 23

Low friction Acetal

Max w. load: 2500 N
Weight: 8,5 kg/m²
Temp. range dry: -40+80 °C
Temp. range wet: -40+65 °C
Pin material: PBT white

PFX - Code 30

Extra performance PBT

Max w. load: 2000 N
Weight: 8,2 kg/m²
Temp. range dry: -40+120 °C
Temp. range wet: -40+60 °C
Pin material: POM grey

THE BEST CHOICE FOR DRY RUNNING APPLICATIONS



- Easier installation
- Quicker maintenance
- 10% Higher strength

K330 Version A - Standard

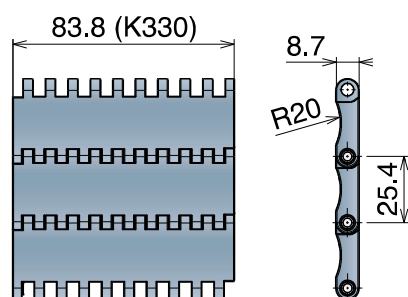

K450 Version A - Standard

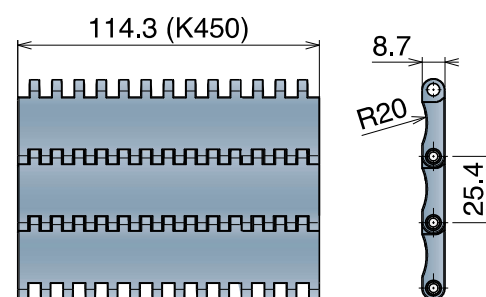

Version C - With 2 Positioner

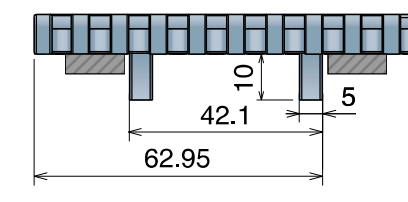

Version C - With 2 Positioner

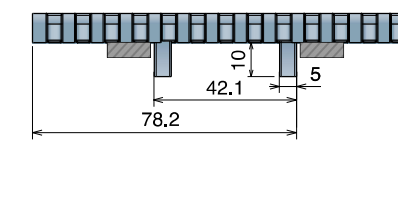

Series	Material	Width	Version
5221	*	9330	A
5221	*	9330	C

Series	Material	Width	Version
5221	*	9450	A
5221	*	9450	C

Disassembling / Assembling mode



550 FT One track belt MOVEX TOOL

The specific tool for belts developed to facilitate belt assembly and disassembly.



Article Nr. **29970**

Movex tools are made with 3D printer, the color may vary due to availability of the material.

550 FTT

Tappeto Modulare 550 FTT, H=8,7 M=85

Modular Belt Series 550 FTT, H=8,7 M=85 / Modulare Mattenkette 550 FTT, H=8,7 M=85

CODE STRUCTURE GUIDE (Example)

Backflex radius min.: 25 mm

5506	01	0085	C
Series	*Material	Width	Version

25.4mm
PITCH



pg. 362/363



pg. 771>781

*Material

LFA - Code 01

Low friction Acetal

MX - Code 03

Performance PBT

Max w. load:	30000 N/m	Max w. load:	24000 N/m
Weight:	8,5 kg/m ²	Weight:	8,2 kg/m ²
Temp. range dry:	-40÷80 °C	Temp. range dry:	-40÷120 °C
Temp. range wet:	-40÷65 °C	Temp. range wet:	-40÷60 °C
Pin material:	PBT white	Pin material:	POM grey



- Easier installation
- Quicker maintenance
- 100% interchangeable

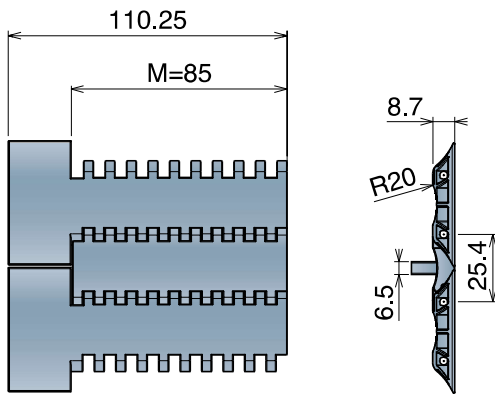

Version C

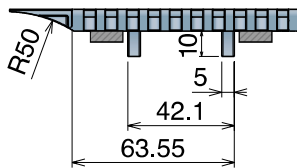

Version C

Series	Material	Width	Version
5506	*	0085	C

Max working load (N)

Width	85
LFA	2300
MX	1850

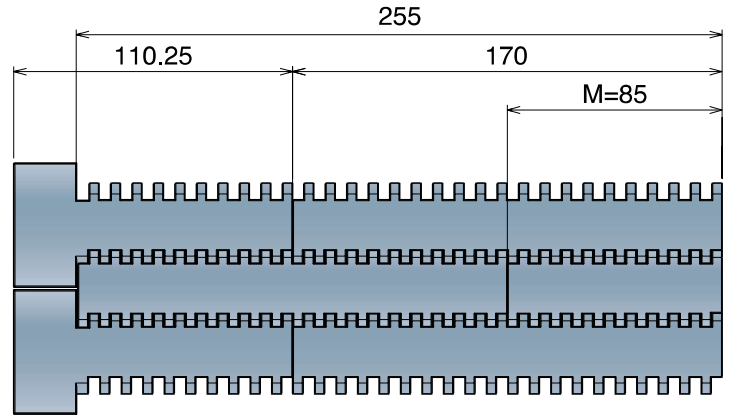

Version CN - Near

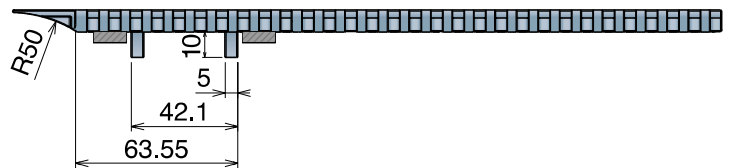

Version CO - Opposite

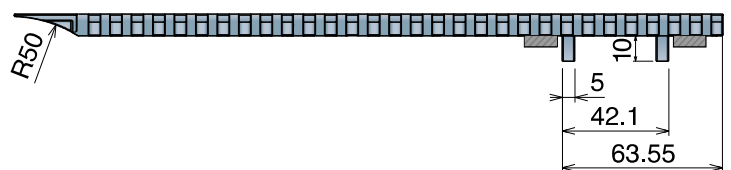

Version CN - Near

Series	Material	Width	Version
5506	*	0170	CN
5506	*	0255	CN

Version CO - Opposite

Series	Material	Width	Version
5506	*	0170	CO
5506	*	0255	CO

NEW

550 UTS

Open Surface 25% Tappeto Modulare 550 UTS, H=8,7 M=85
Modular Belt Series 550 UTS, H=8,7 M=85 / Modulare Mattenkette 550 UTS, H=8,7 M=85

Metric Size

CODE STRUCTURE GUIDE (Example)

Backflex radius min.: 25 mm

5502	01	0085	A
Series	*Material	Width	Version

25.4mm
PITCH

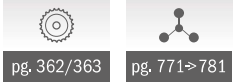
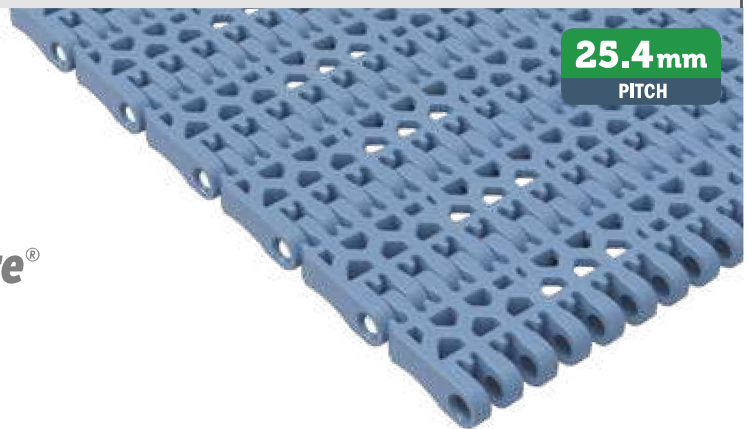

SAMPLE BOX

Art.-Nr. **5502018888A**

***Material**

LFA - Code 01
Low friction Acetal

Easy Delivery

Max w. load: 30000 N/m
Weight: 7,0 kg/m²
Temp. range dry: -40÷80 °C
Temp. range wet: -40÷65 °C
Pin material: PBT white

MX - Code 03
Performance PBT

Max w. load: 24000 N/m
Weight: 6,7 kg/m²
Temp. range dry: -40÷120 °C
Temp. range wet: -40÷60 °C
Pin material: POM grey

LFB - Code 23
Low friction Acetal

Max w. load: 30000 N/m
Weight: 7,0 kg/m²
Temp. range dry: -40÷80 °C
Temp. range wet: -40÷65 °C
Pin material: PBT white

PFX - Code 30
Extra performance PBT

Max w. load: 24000 N/m
Weight: 6,7 kg/m²
Temp. range dry: -40÷120 °C
Temp. range wet: -40÷60 °C
Pin material: POM grey

THE BEST CHOICE FOR DRY RUNNING APPLICATIONS



- Easier installation
- Quicker maintenance
- 100% interchangeable

Version A - Standard

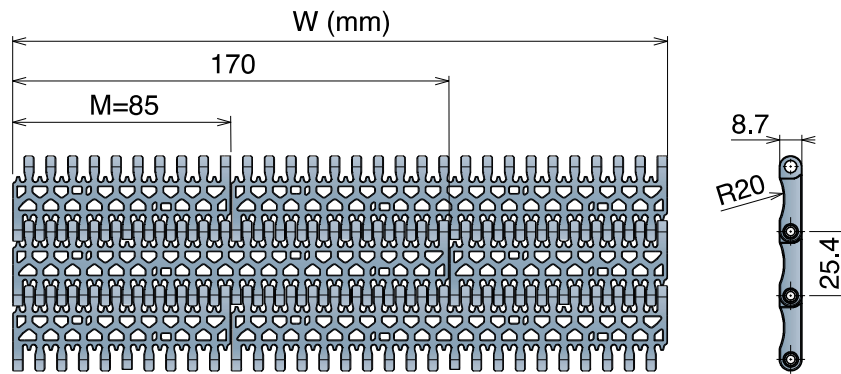

Version B - With 1 Positioner

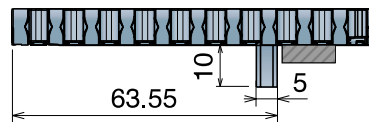

Version C - With 2 Positioner

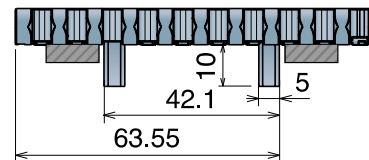

Version A - Standard

Series	Material	Width	Version
5502	*	0085	A
5502	*	0170	A
5502	*	0255	A
5502	*	0340	A
5502	*	0425	A
5502	*	0510	A
5502	*	0595	A
5502	*	0680	A
5502	*	0765	A
5502	*	0850	A
5502	*	0935	A
5502	*	1020	A
5502	*	1105	A
5502	*	1190	A
5502	*	1275	A
5502	*	1360	A
5502	*	1445	A
5502	*	1530	A

Version B - With 1 Positioner

Series	Material	Width	Version
5502	*	0085	B
5502	*	0170	B
5502	*	0255	B
5502	*	0340	B
5502	*	0425	B
5502	*	0510	B
5502	*	0595	B
5502	*	0680	B
5502	*	0765	B
5502	*	0850	B
5502	*	0935	B
5502	*	1020	B
5502	*	1105	B
5502	*	1190	B
5502	*	1275	B
5502	*	1360	B
5502	*	1445	B
5502	*	1530	B

Version C - With 2 Positioners

Series	Material	Width	Version
5502	*	0085	C
5502	*	0170	C
5502	*	0255	C
5502	*	0340	C
5502	*	0425	C
5502	*	0510	C
5502	*	0595	C
5502	*	0680	C
5502	*	0765	C
5502	*	0850	C
5502	*	0935	C
5502	*	1020	C
5502	*	1105	C
5502	*	1190	C
5502	*	1275	C
5502	*	1360	C
5502	*	1445	C
5502	*	1530	C

One modular belt, countless uses.

The benefits of a flat top and flush grid belts, combined. Ideal for...



✓ Simplifying your line layout and inventory management.

✓ Saving resources, energy and maintenance time.

550 UTS One track Belt

Tappeti modulari / Modular belts / Mattenketten

PATENTED

Belts wider than standard are available with 85 mm increments

NEW 550 UTS One track Belt Open Surface 25% Tappeto Modulare 550 UTS, H=8,7 K330 Modular Belt Series 550 UTS, H=8,7 K330 / Modulare Mattenkette 550 UTS, H=8,7 K330

Metric Size

CODE STRUCTURE GUIDE (Example)

Backflex radius min.: 25 mm

5502	01	9330	A
Series	*Material	Width	Version

25.4mm
PITCH

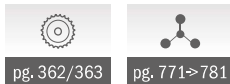

pg. 362/363

pg. 771>781

*Material

LFA - Code 01

Low friction Acetal

Easy Delivery

Max w. load: 2500 N
Weight: 7,0 kg/m²
Temp. range dry: -40+80 °C
Temp. range wet: -40+65 °C
Pin material: PBT white

MX - Code 03

Performance PBT

Max w. load: 2000 N
Weight: 6,7 kg/m²
Temp. range dry: -40+120 °C
Temp. range wet: -40+60 °C
Pin material: POM grey

LFB - Code 23

Low friction Acetal

Max w. load: 2500 N
Weight: 7,0 kg/m²
Temp. range dry: -40+80 °C
Temp. range wet: -40+65 °C
Pin material: PBT white

PFX - Code 30

Extra performance PBT

Max w. load: 2000 N
Weight: 6,7 kg/m²
Temp. range dry: -40+120 °C
Temp. range wet: -40+60 °C
Pin material: POM grey

**THE BEST CHOICE FOR
DRY RUNNING APPLICATIONS**

One modular belt, countless uses.

The benefits of a flat top and flush grid belts, combined. Ideal for...



Petaloid bases



Aluminum & steel cans



Glass bottles & jars

✓ Simplifying your line layout and inventory management.

✓ Saving resources, energy and maintenance time.



- Easier installation
- Quicker maintenance
- 100% interchangeable

Version A - Standard

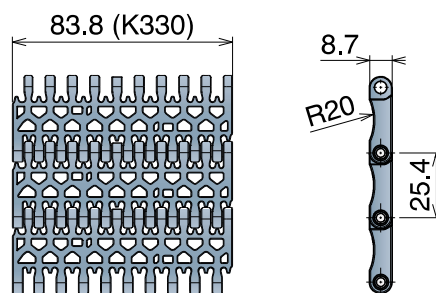

Version C - With 2 Positioner

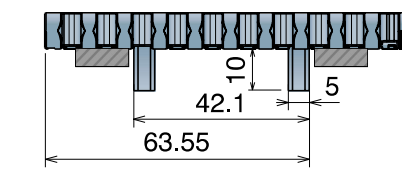

Version A - Standard

Series	Material	Width	Version
5502	*	9330	A

Version C - With 2 Positioners

Series	Material	Width	Version
5502	*	9330	C

550 UTS and One track belt MOVEX TOOL

The specific tool for belts developed to facilitate belt assembly and disassembly.



Article Nr. **29970**

550 GT

Tappeto Modulare 550 GT, H=8,7 M=85

Modular Belt Series 550 GT, H=8,7 M=85 / Modulare Mattenkette 550 GT, H=8,7 M=85

CODE STRUCTURE GUIDE (Example)

Backflex radius min.: 30 mm

5503	01	0085	A
Series	*Material	Width	Version

25.4mm
PITCH

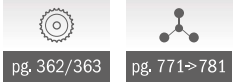

pg. 362/363

pg. 771>781

SAMPLE BOX

Art.-Nr. **5503018388A**



- Easier installation
- Quicker maintenance
- 100% interchangeable

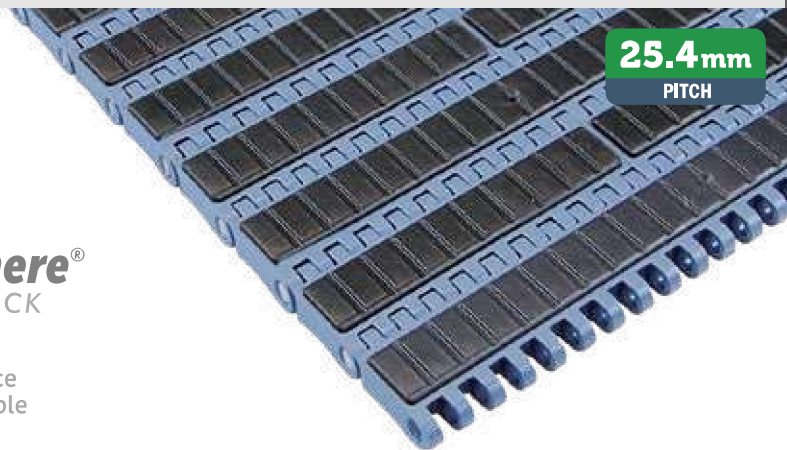

Metric Size

*Material

LFA - Code 01

Low friction Acetal

Max w. load: 27500 N/m
 Weight: 10,1 kg/m²
 Temp. range dry: -40÷80 °C
 Temp. range wet: -40÷65 °C
 Pin material: PBT white
 Top rubber: 50 ShA-Dark grey

PP - Code 02

Polypropylene

Max w. load: 16500 N/m
 Weight: 8,4 kg/m²
 Temp. range dry: 4÷80 °C
 Temp. range wet: 4÷80 °C
 Pin material: PP blue
 Top rubber: 50 ShA-Pigeon blue

MX - Code 03

Performance PBT

Max w. load: 21500 N/m
 Weight: 10,5 kg/m²
 Temp. range dry: -40÷120 °C
 Temp. range wet: -40÷60 °C
 Pin material: POM grey
 Top rubber: 50 ShA-Dark grey

Version A - Standard

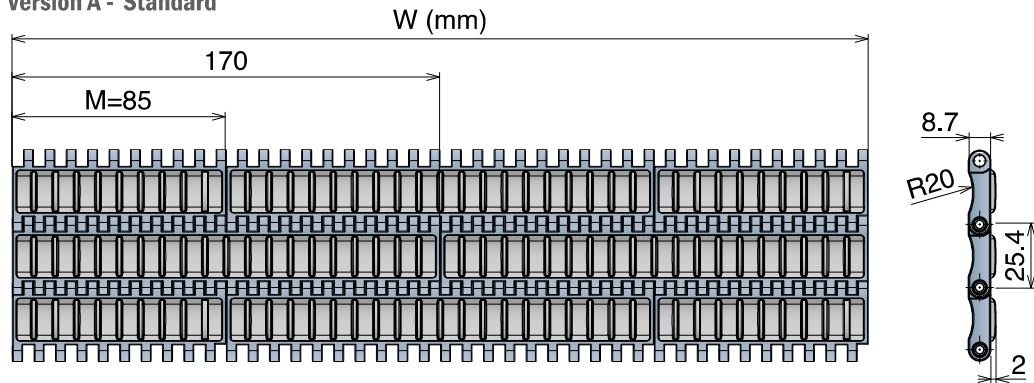

Version B - With 1 Positioner

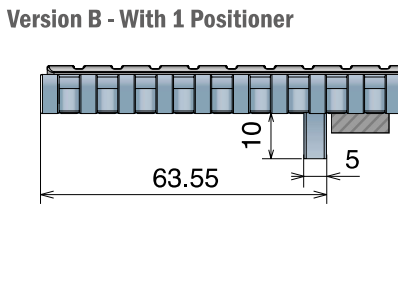

Version C - With 2 Positioners

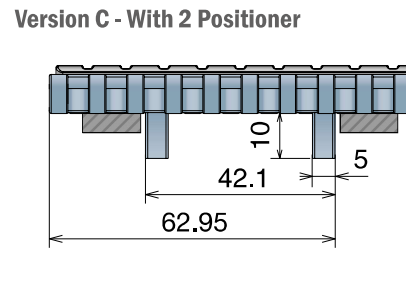

Version A - Standard

Series	Material	Width	Version
5503	*	0085	A
5503	*	0170	A
5503	*	0255	A
5503	*	0340	A
5503	*	0425	A
5503	*	0510	A
5503	*	0595	A
5503	*	0680	A
5503	*	0765	A
5503	*	0850	A
5503	*	0935	A
5503	*	1020	A
5503	*	1105	A
5503	*	1190	A
5503	*	1275	A
5503	*	1360	A
5503	*	1445	A
5503	*	1530	A

Version B - With 1 Positioner

Series	Material	Width	Version
5503	*	0085	B
5503	*	0170	B
5503	*	0255	B
5503	*	0340	B
5503	*	0425	B
5503	*	0510	B
5503	*	0595	B
5503	*	0680	B
5503	*	0765	B
5503	*	0850	B
5503	*	0935	B
5503	*	1020	B
5503	*	1105	B
5503	*	1190	B
5503	*	1275	B
5503	*	1360	B
5503	*	1445	B
5503	*	1530	B

Version C - With 2 Positioners

Series	Material	Width	Version
5503	*	0085	C
5503	*	0170	C
5503	*	0255	C
5503	*	0340	C
5503	*	0425	C
5503	*	0510	C
5503	*	0595	C
5503	*	0680	C
5503	*	0765	C
5503	*	0850	C
5503	*	0935	C
5503	*	1020	C
5503	*	1105	C
5503	*	1190	C
5503	*	1275	C
5503	*	1360	C
5503	*	1445	C
5503	*	1530	C

550 GT Side indent

Tappeto Modulare 550 GT, H=8,7 M=85
Modular Belt Series 550 GT, H=8,7 M=85 / Modulare Mattenkette 550 GT, H=8,7 M=85

CODE STRUCTURE GUIDE (Example)

Backflex radius min.: 30 mm

5505	01	0255	A
Series	*Material	Width	Version

25.4mm
PITCH

Metric Size



- Easier installation
- Quicker maintenance
- 100% interchangeable

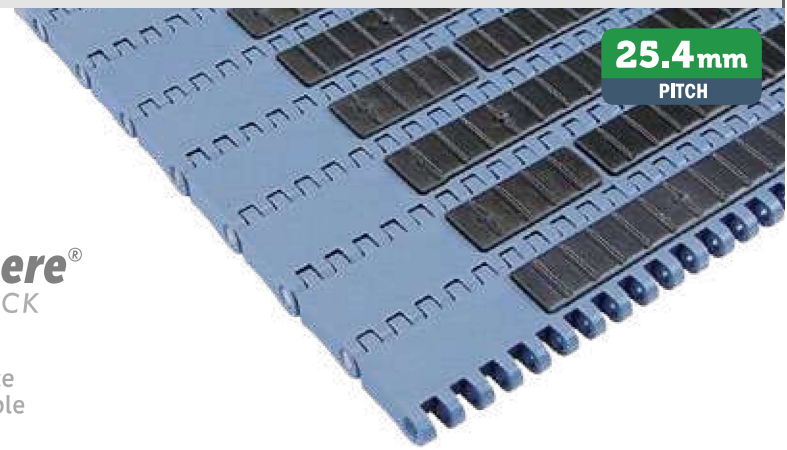

***Material**

LFA - Code 01
Low friction Acetal

Max w. load: 27500 N/m
Weight: 10,1 kg/m²
Temp. range dry: -40+80 °C
Temp. range wet: -40+65 °C
Pin material: PBT white
Top rubber: 50 ShA-Dark grey

PP - Code 02
Polypropylene

Max w. load: 16500 N/m
Weight: 8,4 kg/m²
Temp. range dry: 4+80 °C
Temp. range wet: 4+80 °C
Pin material: PP blue
Top rubber: 50 ShA-Pigeon blue

MX - Code 03
Performance PBT

Max w. load: 21500 N/m
Weight: 10,5 kg/m²
Temp. range dry: -40+120 °C
Temp. range wet: -40+60 °C
Pin material: POM grey
Top rubber: 50 ShA-Dark grey

Version A - Standard

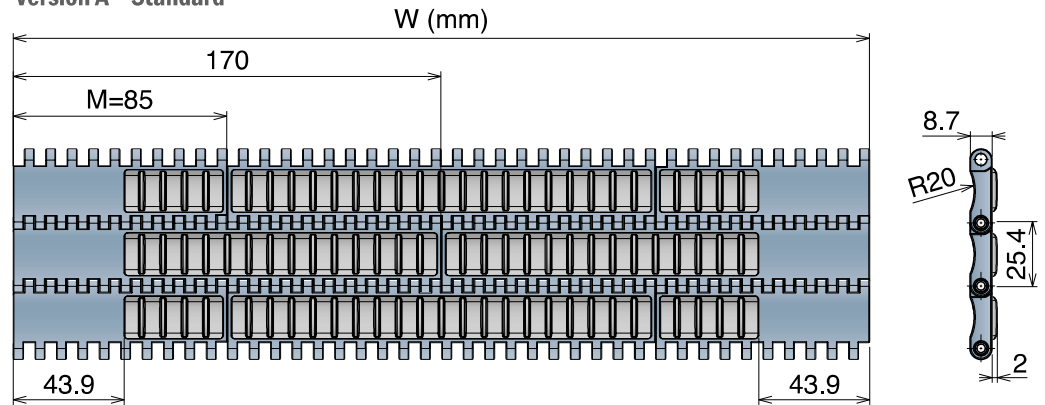

Version B - With 1 Positioner

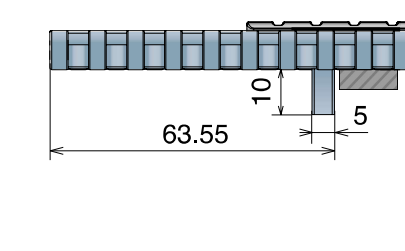

Version C - With 2 Positioners

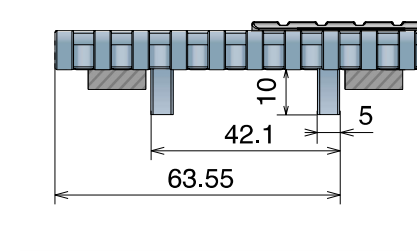

Version A - Standard

Series	Material	Width	Version
5505	*	0255	A
5505	*	0340	A
5505	*	0425	A
5505	*	0510	A
5505	*	0595	A
5505	*	0680	A
5505	*	0765	A
5505	*	0850	A
5505	*	0935	A
5505	*	1020	A
5505	*	1105	A
5505	*	1190	A
5505	*	1275	A
5505	*	1360	A
5505	*	1445	A
5505	*	1530	A

Version B - With 1 Positioner

Series	Material	Width	Version
5505	*	0255	B
5505	*	0340	B
5505	*	0425	B
5505	*	0510	B
5505	*	0595	B
5505	*	0680	B
5505	*	0765	B
5505	*	0850	B
5505	*	0935	B
5505	*	1020	B
5505	*	1105	B
5505	*	1190	B
5505	*	1275	B
5505	*	1360	B
5505	*	1445	B
5505	*	1530	B

Version C - With 2 Positioners

Series	Material	Width	Version
5505	*	0255	C
5505	*	0340	C
5505	*	0425	C
5505	*	0510	C
5505	*	0595	C
5505	*	0680	C
5505	*	0765	C
5505	*	0850	C
5505	*	0935	C
5505	*	1020	C
5505	*	1105	C
5505	*	1190	C
5505	*	1275	C
5505	*	1360	C
5505	*	1445	C
5505	*	1530	C

550 FLIGHT TOP Tappeto Modulare 550 with Flight, H=8,7 M=85

Modular Belt Series 550 with Flight, H=8,7 M=85 / Modulare Mattenkette 550 with Flight, H=8,7 M=85

CODE STRUCTURE GUIDE

Backflex radius min.: 30 mm

See following table

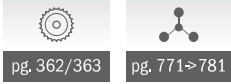

pg. 362/363

pg. 771>781

SAMPLE BOX

Art.-Nr. **5509018888A**

Material

LFA - Code 01

Low friction Acetal

Max w. load: 30000 N/m
 Weight: 8,5 kg/m²
 Temp. range dry: -40÷80 °C
 Temp. range wet: -40÷65 °C
 Pin material: PBT white

PP - Code 02

Polypropylene

Max w. load: 18000 N/m
 Weight: 8,4 kg/m²
 Temp. range dry: 4÷104 °C
 Temp. range wet: 4÷104 °C
 Pin material: PP blue

LFW - Code 05

Low friction Acetal

Max w. load: 30000 N/m
 Weight: 8,5 kg/m²
 Temp. range dry: -40÷80 °C
 Temp. range wet: -40÷65 °C
 Pin material: PBT white

PPW - Code 21

Polypropylene

Max w. load: 18000 N/m
 Weight: 8,4 kg/m²
 Temp. range dry: 4÷104 °C
 Temp. range wet: 4÷104 °C
 Pin material: PP blue

LFB - Code 23

Low friction Acetal

Max w. load: 30000 N/m
 Weight: 8,5 kg/m²
 Temp. range dry: -40÷80 °C
 Temp. range wet: -40÷65 °C
 Pin material: PBT white



- Easier installation
- Quicker maintenance
- 100% interchangeable



Metric Size

Version A - Standard

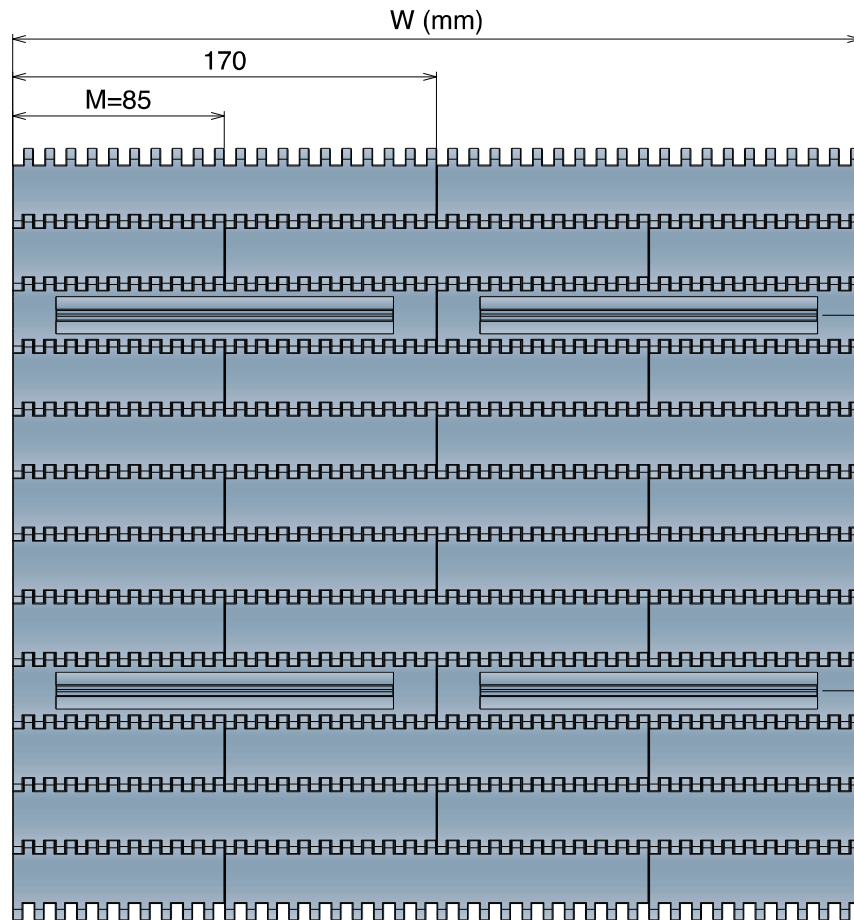
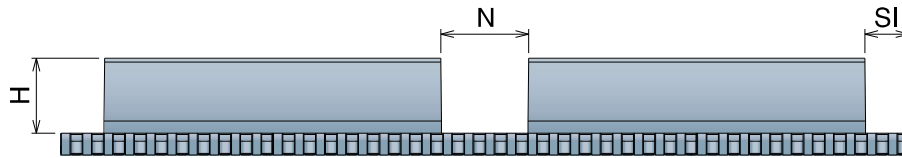

THE PERFECT SOLUTION TO CONVEY EVERY TYPE OF PRODUCTS UP AN INCLINE!

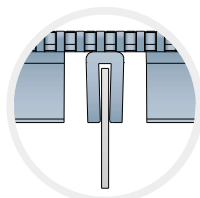

Notch utility
RETURN SECTION with Bar-cap

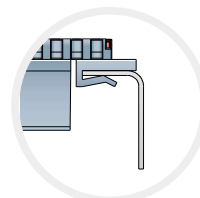

Side indent utility
RETURN SECTION with Z-Profile & J-Profile

Request for quotation

Technical drawing

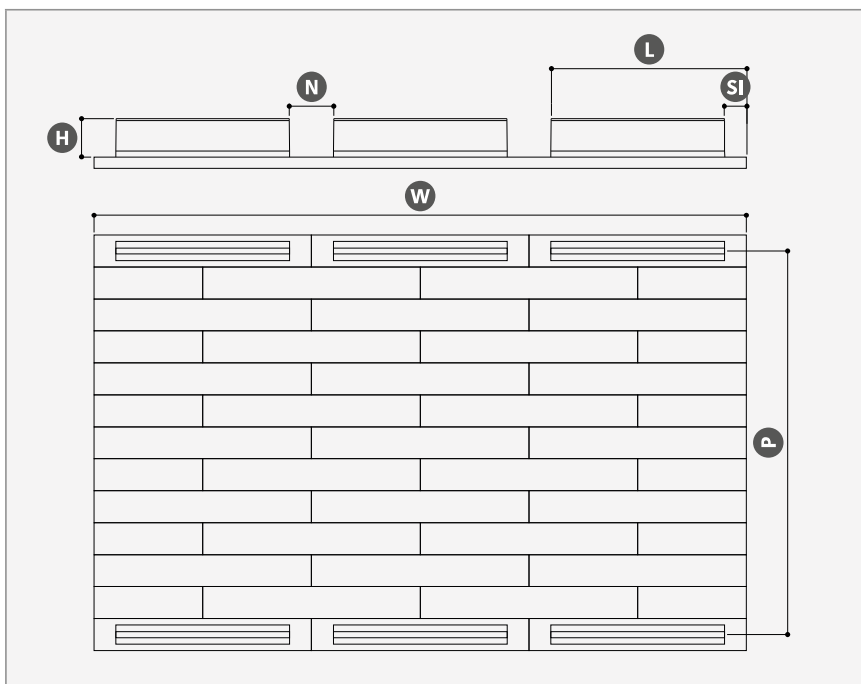

Please fill out the following form or add dimensions into the drawing.

Company

Sales contact

Contact

Date

For different combination, please ask to your sales representative.

Fill out the form and send to your sales contact or to:

info@movexii.com

Technical features

Dimension expressed in millimeter

Belt surface	Flat Top (FT)		Flush Grid (FG)		Grip Top (GT)	
Material & colour	LFA	LFW	LFB	PP	PPW	
W - Width	Standard (85 multiple)			Special (17 multiple)		
H - Flight height	Standard 30	Standard 51	Standard 76	Special (Max 76)		
P - Pitch	Number of pitches or distance between flights (25,4 mm multiple)					
SI - Side Indent*	No	17	30	50		
Notch*	No	Single	Double	Triple		
	N - Notch width (preferred 34 or 60 mm)			L - Notch distance (2 or more)		

Configuration recommended

Dimensions expressed in millimeter

Width ≤ 170	170 > Width ≤ 425	425 > Width ≤ 850	Width > 850

NEW 550 V

Tappeto Modulare 550 GT, H=8,7 M=85
Modular Belt Series 550 GT, H=8,7 M=85 / Modulare Mattenkette 550 GT, H=8,7 M=85

CODE STRUCTURE GUIDE (Example)

Backflex radius min.: 25 mm

5508	01	0085	A
Series	*Material	Width	Version

25.4mm
PITCH

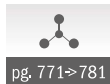

- Easier installation
- Quicker maintenance
- 100% interchangeable

Metric Size

*Material

LFA - Code 01 Low friction Acetal

Max w. load: 25500 N/m
Weight: 9,0 kg/m²
Temp. range dry: -40+80 °C
Temp. range wet: -40+65 °C
Pin material: PBT white

MX - Code 03 Performance PBT

Max w. load: 20500 N/m
Weight: 8,7 kg/m²
Temp. range dry: -40+120 °C
Temp. range wet: -40+60 °C
Pin material: POM grey

AS - Code 12 Antistatic Acetal

Max w. load: 2500 N/m
Weight: 8,5 kg/m²
Temp. range dry: -40+120 °C
Temp. range wet: -40+60 °C
Pin material: PBT white

AS MATERIAL
IS AVAILABLE ONLY FOR
ONE TRACK BELT VERSION

Version A - Standard

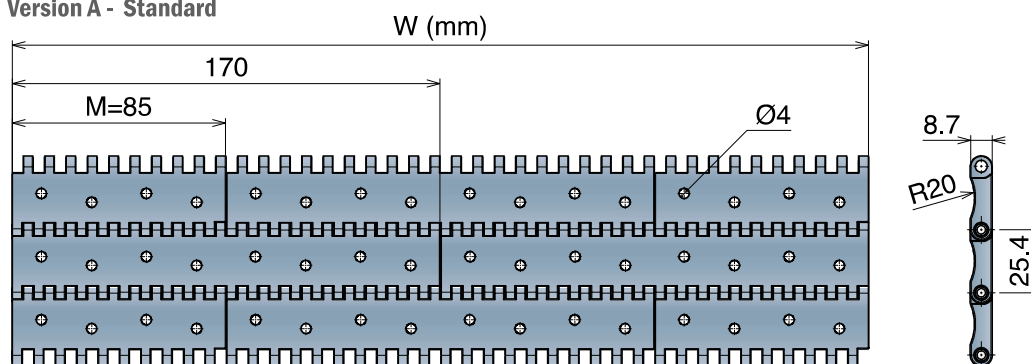

One track Belt version

K85 Version A - Standard

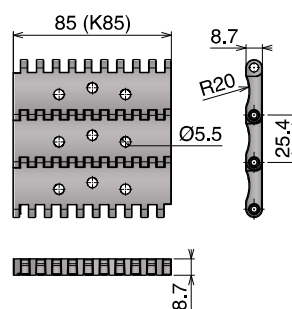

Article-Nr

5508129085A

Version A - Standard

Series	Material	Width	Version
5508	*	0085	A
5508	*	0170	A
5508	*	0255	A
5508	*	0340	A
5508	*	0425	A
5508	*	0510	A
5508	*	0595	A
5508	*	0680	A
5508	*	0765	A
5508	*	0850	A
5508	*	0935	A
5508	*	1020	A
5508	*	1105	A
5508	*	1190	A
5508	*	1275	A
5508	*	1360	A
5508	*	1445	A
5508	*	1530	A

K450 Version A - Standard

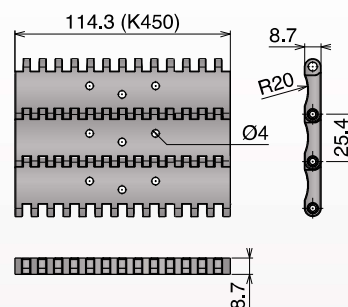

Article-Nr

5508129115A

550 PRO FT

Tappeto Modulare 550 PRO FT, H=8,7 K330
 Modular Belt Series 550 PRO FT, H=8,7 K330 / Modulare Mattenkette 550 PRO FT, H=8,7 K330

CODE STRUCTURE GUIDE (Example)

Backflex radius min.: 25 mm

5227	01	9330	A
Series	*Material	Width	Version

25.4mm
PITCH

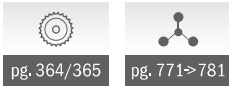

550 PRO FT & PRO M
 SAMPLE BOX
 Art.-Nr. 5227018888A



- Easier installation
- Quicker maintenance
- 100% interchangeable

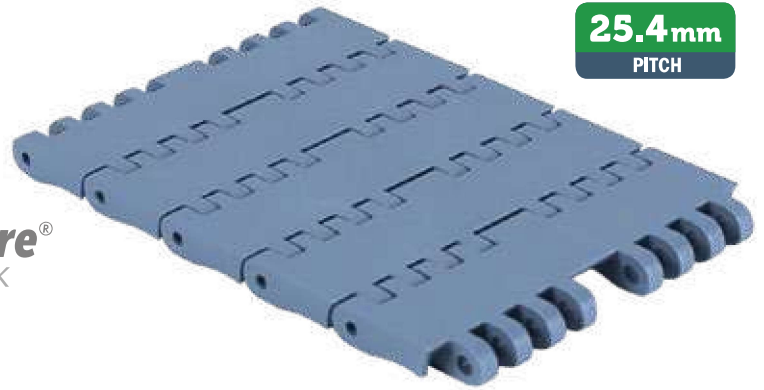

***Material**

LFA - Code 01
 Low friction Acetal

Easy Delivery

Max w. load: 2300 N
 Weight: 8,5 kg/m²
 Temp. range dry: -40+80 °C
 Temp. range wet: -40+65 °C
 Pin material: PBT white

MX - Code 03
 Performance PBT

Max w. load: 1850 N
 Weight: 8,2 kg/m²
 Temp. range dry: -40+120 °C
 Temp. range wet: -40+60 °C
 Pin material: POM grey

PFX - Code 30
 Extra performance PBT

Max w. load: 1850 N
 Weight: 8,2 kg/m²
 Temp. range dry: -40+120 °C
 Temp. range wet: -40+60 °C
 Pin material: POM grey

**THE BEST CHOICE FOR
 DRY RUNNING APPLICATIONS**

Version A - Standard

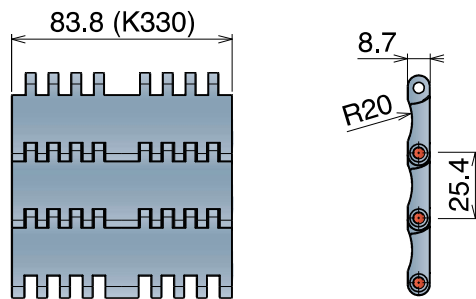

Version C - With 2 Positioner

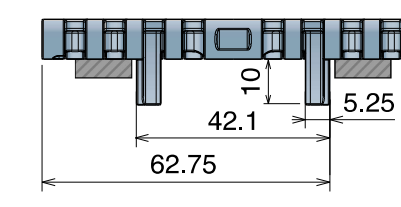

Advantages:

- Optimized product support
- Superior flatness
- Low wear
- Bi-directional

Version A - Standard

Series	Material	Width	Version
5227	*	9330	A

Version C - With 2 Positioners

Series	Material	Width	Version
5227	*	9330	C

550 PRO M & 550 PRO FT

The perfect combination

- Same height between guide and center sprockets (S Dimension)
- Same speed for curved and straight
- Unique sprocket for curved and straight

Layout with 550 Pro M and 550 PRO FT

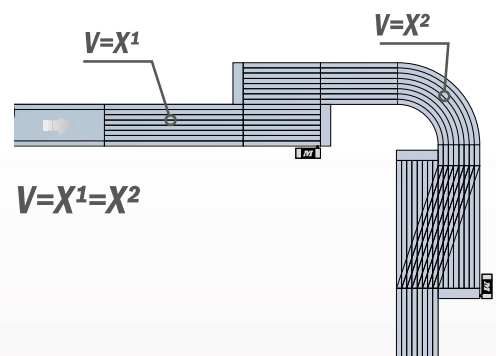

550 PRO M

Tappeto Modulare 550 PRO M, H=8,7 K330
 Modular Belt Series 550 PRO M, H=8,7 K330 / Modulare Mattenkette 550 PRO M, H=8,7 K330

CODE STRUCTURE GUIDE (Example)

Backflex radius min.: 15 mm

5228	30	9330	C
Series	*Material	Width	Version

25.4mm
PITCH

10 feet 3.048 m	pg. 364/365	pg. 178	pg. 771->781
240 links			

MAGNETIC SYSTEM

550 PRO FT & PRO M

SAMPLE BOX

Art.-Nr. **522701888A**



- Easier installation • Quicker maintenance
- 100% interchangeable

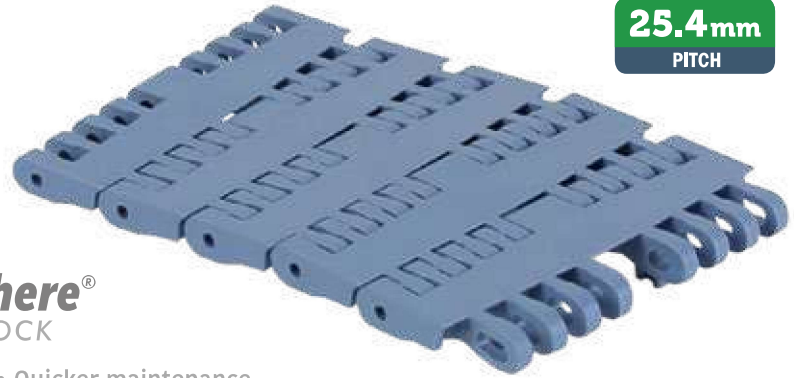

Metric Size

*Material

LFA - Code 01

Low friction Acetal

Easy Delivery

Max w. load: 2500 N
 Weight: 8,2 kg/m²
 Temp. range dry: -40÷80 °C
 Temp. range wet: -40÷65 °C
 Pin material: Ferritic
 Stainless Steel

MX - Code 03

Performance PBT

Max w. load: 2000 N
 Weight: 8,0 kg/m²
 Temp. range dry: -40÷120 °C
 Temp. range wet: -40÷60 °C
 Pin material: Ferritic
 Stainless Steel

PFX - Code 30

Extra performance PBT

Max w. load: 2000 N
 Weight: 8,0 kg/m²
 Temp. range dry: -40÷120 °C
 Temp. range wet: -40÷60 °C
 Pin material: Ferritic
 Stainless Steel

**THE BEST CHOICE FOR
 DRY RUNNING APPLICATIONS**

Version C - With 2 Positioner

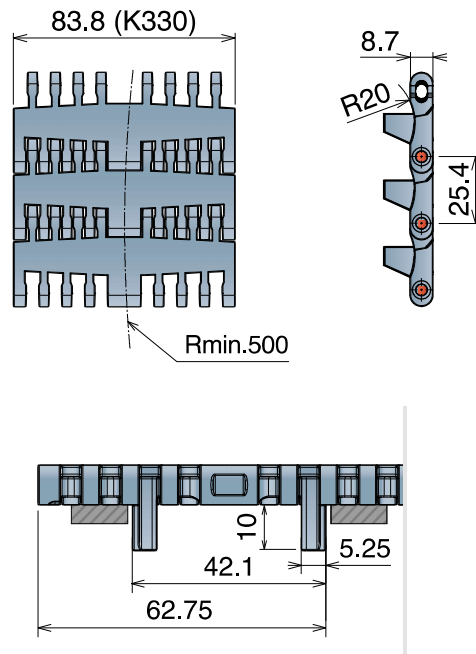

Advantages:

- Optimized product support
- Superior flatness
- Low wear
- Bi-directional

Version C - With 2 Positioners

Series	Material	Width	Version
5228	*	9330	C

550 PRO M & 550 PRO FT

The perfect combination

- Same height between guide and center sprockets (S Dimension)
- Same speed for curved and straight
- Unique sprocket for curved and straight

Layout with 550 Pro M and 550 PRO FT

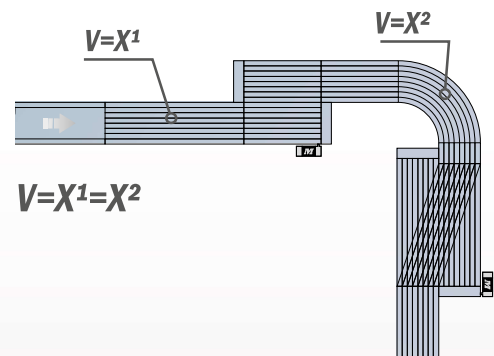

$$V=X^1=X^2$$

551

Pitch 25,4 mm
H= 12,7 mm



551 FT
551 FTT
551 GT
551 GT *Side indent*
551 LBP
551 PRO LBP

551 FT

Tappeto Modulare 551 FT, H=12,7 M=85
Modular Belt Series 551 FT, H=12,7 M=85 / Modulare Mattenkette 551 FT, H=12,7 M=85

CODE STRUCTURE GUIDE (Example)

Backflex radius min.: 25 mm

5231	01	0085	A
Series	*Material	Width	Version

25.4mm
PITCH

*Material

LFA - Code 01
Low friction Acetal

Easy Delivery

Max w. load: 41500 N/m
Weight: 12,5 kg/m²
Temp. range dry: -40+80 °C
Temp. range wet: -40+65 °C
Pin material: PBT white

PP - Code 02
Polypropylene

Max w. load: 27000 N/m
Weight: 10,0 kg/m²
Temp. range dry: 4+104 °C
Temp. range wet: 4+104 °C
Pin material: PP blue

MX - Code 03
Performance PBT

Max w. load: 33500 N/m
Weight: 12,0 kg/m²
Temp. range dry: -40+120 °C
Temp. range wet: -40+60 °C
Pin material: POM grey

DKM - Code 16
Aramid Reinforced Acetal

Max w. load: 41500 N/m
Weight: 12,5 kg/m²
Temp. range dry: -40+80 °C
Temp. range wet: -40+65 °C
Pin material: PBT white

MWX - Code 17
Polyamide Composite

Max w. load: 41500 N/m
Weight: 13,0 kg/m²
Temp. range dry: -40+104 °C
Temp. range wet: NR
Pin material: PBT white

MPX - Code 25
Lubricated Acetal

Max w. load: 41500 N/m
Weight: 12,5 kg/m²
Temp. range dry: -40+80 °C
Temp. range wet: -40+65 °C
Pin material: PBT white

PFX - Code 30
Extra performance PBT

Max w. load: 33500 N/m
Weight: 12,0 kg/m²
Temp. range dry: -40+120 °C
Temp. range wet: -40+60 °C
Pin material: POM grey

**THE BEST CHOICE FOR
DRY RUNNING APPLICATIONS**

SAMPLE BOX

Art.-Nr. **5231018888A**



Version A - Standard

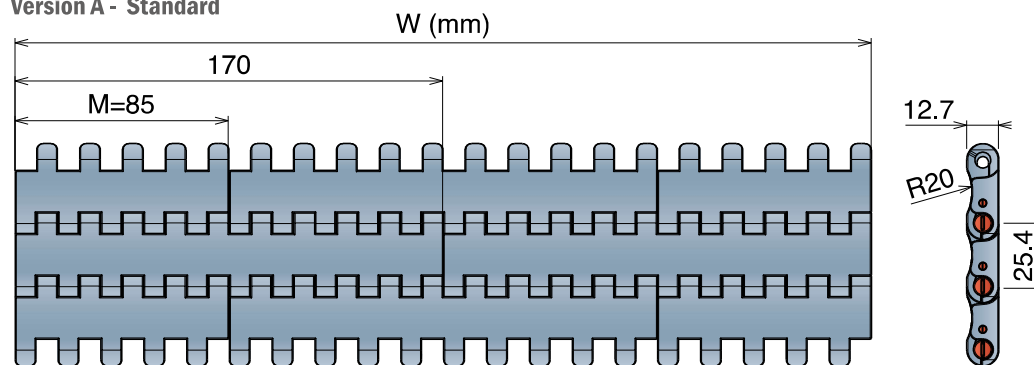

Version B - With 1 Positioner

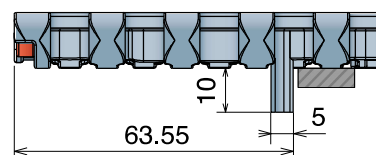

Version C - With 2 Positioners

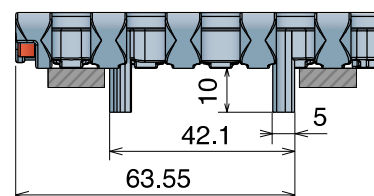

Version A - Standard

Series	Material	Width	Version
5231	*	0085	A
5231	*	0170	A
5231	*	0255	A
5231	*	0340	A
5231	*	0425	A
5231	*	0510	A
5231	*	0595	A
5231	*	0680	A
5231	*	0765	A
5231	*	0850	A
5231	*	0935	A
5231	*	1020	A
5231	*	1105	A
5231	*	1190	A
5231	*	1275	A
5231	*	1360	A
5231	*	1445	A
5231	*	1530	A

Version B - With 1 Positioner

Series	Material	Width	Version
5231	*	0085	B
5231	*	0170	B
5231	*	0255	B
5231	*	0340	B
5231	*	0425	B
5231	*	0510	B
5231	*	0595	B
5231	*	0680	B
5231	*	0765	B
5231	*	0850	B
5231	*	0935	B
5231	*	1020	B
5231	*	1105	B
5231	*	1190	B
5231	*	1275	B
5231	*	1360	B
5231	*	1445	B
5231	*	1530	B

Version C - With 2 Positioners

Series	Material	Width	Version
5231	*	0085	C
5231	*	0170	C
5231	*	0255	C
5231	*	0340	C
5231	*	0425	C
5231	*	0510	C
5231	*	0595	C
5231	*	0680	C
5231	*	0765	C
5231	*	0850	C
5231	*	0935	C
5231	*	1020	C
5231	*	1105	C
5231	*	1190	C
5231	*	1275	C
5231	*	1360	C
5231	*	1445	C
5231	*	1530	C

Metric Size

pg. 366-367

pg. 771-781

551 FTT

Tappeto Modulare 551 FTT, H=12,7 M=85

Modular Belt Series 551 FTT, H=12,7 M=85 / Modulare Mattenkette 551 FTT, H=12,7 M=85

CODE STRUCTURE GUIDE (Example)

Backflex radius min.: 25 mm

5236	01	0085	C
Series	*Material	Width	Version

25.4mm
PITCH

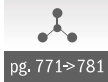

*Material

LFA - Code 01 <i>Low friction Acetal</i>	MX - Code 03 <i>Performance PBT</i>	MPX - Code 25 <i>Lubricated Acetal</i>
---	--	---

Max w. load: 41500 N/m	Max w. load: 33500 N/m	Max w. load: 41500 N/m
Weight: 12,5 kg/m ²	Weight: 12,0 kg/m ²	Weight: 12,5 kg/m ²
Temp. range dry: -40+80 °C	Temp. range dry: -40+120 °C	Temp. range dry: -40+80 °C
Temp. range wet: -40+65 °C	Temp. range wet: -40+60 °C	Temp. range wet: -40+65 °C
Pin material: PBT white	Pin material: POM grey	Pin material: PBT white

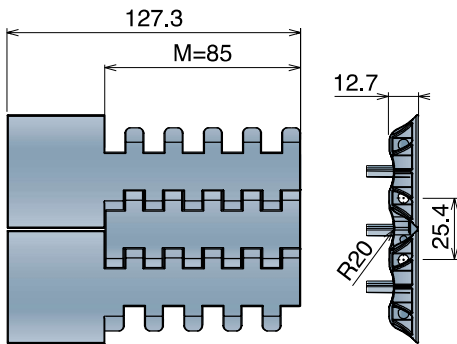

Version C

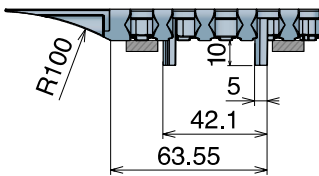

Version C

Series	Material	Width	Version
5236	*	0085	C

Max working load (N)

Width	85
LFA	3500
MX	2800
MPX	3500

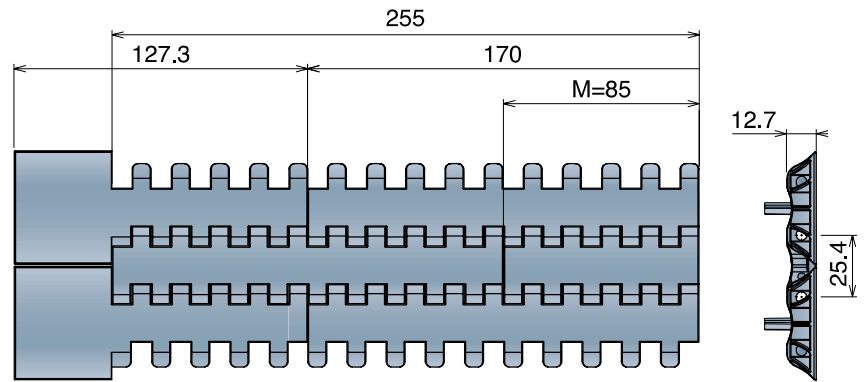

Version CN - Near

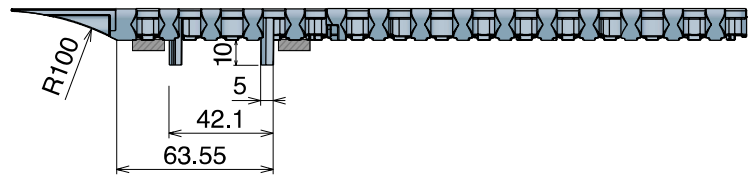

Version CO - Opposite

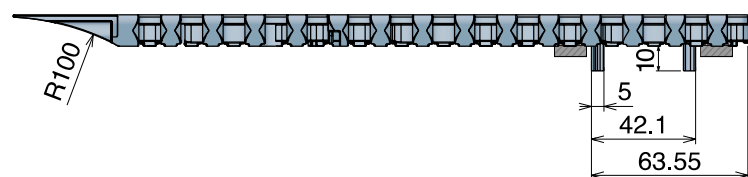

Version CN - Near

Series	Material	Width	Version
5236	*	0170	CN
5236	*	0255	CN

Version CO - Opposite

Series	Material	Width	Version
5236	*	0170	CO
5236	*	0255	CO

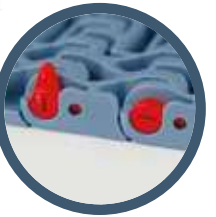

551 GT

Tappeto Modulare 551 GT, H=12,7 M=85
 Modular Belt Series 551 GT, H=12,7 M=85 / Modulare Mattenkette 551 GT, H=12,7 M=85

Metric Size

CODE STRUCTURE GUIDE (Example)

Backflex radius min.: 50 mm

5233	01	0085	A
Series	*Material	Width	Version



25.4mm
PITCH

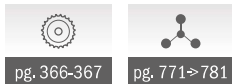

pg. 366-367

pg. 771>781

SAMPLE BOX	
Art.-Nr.	5233018888A



*Material

LFA - Code 01
Low friction Acetal

Easy Delivery

Max w. load: 41500 N/m
 Weight: 13,5 kg/m²
 Temp. range dry: -40÷80 °C
 Temp. range wet: -40÷65 °C
 Pin material: PBT white
 Top rubber: 50 ShA-Dark grey

PP - Code 02
Polypropylene

Max w. load: 27000 N/m
 Weight: 11,0 kg/m²
 Temp. range dry: 4÷80 °C
 Temp. range wet: 4÷80 °C
 Pin material: PP blue
 Top rubber: 50 ShA-Pigeon blue

MX - Code 03
Performance PBT

Max w. load: 33500 N/m
 Weight: 12,7 kg/m²
 Temp. range dry: -40÷120 °C
 Temp. range wet: -40÷60 °C
 Pin material: POM grey
 Top rubber: 50 ShA-Dark grey

Version A - Standard

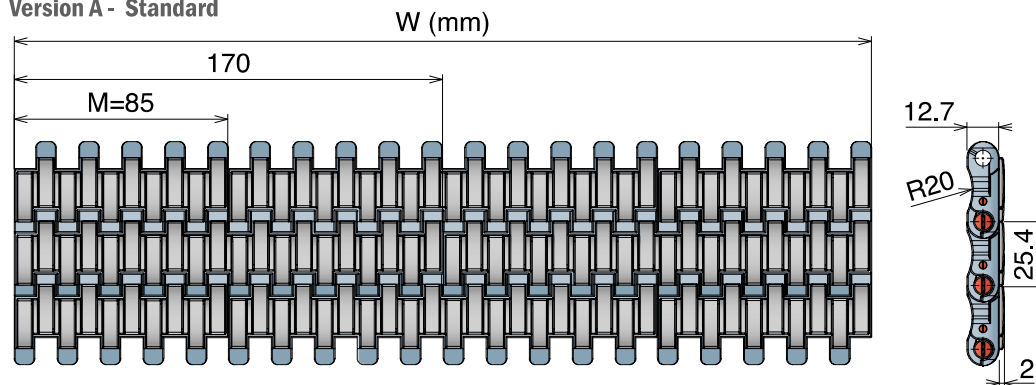

Version B - With 1 Positioner

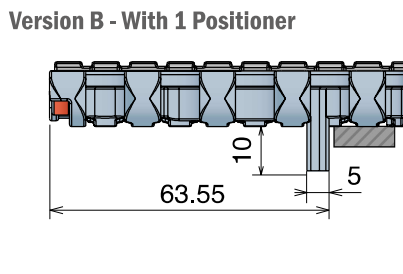

Version C - With 2 Positioners

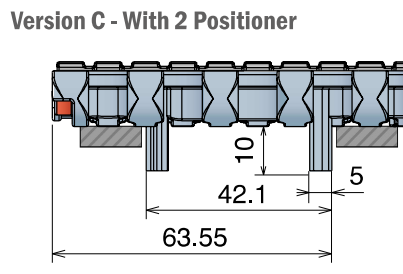

Version A - Standard

Series	Material	Width	Version
5233	*	0085	A
5233	*	0170	A
5233	*	0255	A
5233	*	0340	A
5233	*	0425	A
5233	*	0510	A
5233	*	0595	A
5233	*	0680	A
5233	*	0765	A
5233	*	0850	A
5233	*	0935	A
5233	*	1020	A
5233	*	1105	A
5233	*	1190	A
5233	*	1275	A
5233	*	1360	A
5233	*	1445	A
5233	*	1530	A

Version B - With 1 Positioner

Series	Material	Width	Version
5233	*	0085	B
5233	*	0170	B
5233	*	0255	B
5233	*	0340	B
5233	*	0425	B
5233	*	0510	B
5233	*	0595	B
5233	*	0680	B
5233	*	0765	B
5233	*	0850	B
5233	*	0935	B
5233	*	1020	B
5233	*	1105	B
5233	*	1190	B
5233	*	1275	B
5233	*	1360	B
5233	*	1445	B
5233	*	1530	B

Version C - With 2 Positioners

Series	Material	Width	Version
5233	*	0085	C
5233	*	0170	C
5233	*	0255	C
5233	*	0340	C
5233	*	0425	C
5233	*	0510	C
5233	*	0595	C
5233	*	0680	C
5233	*	0765	C
5233	*	0850	C
5233	*	0935	C
5233	*	1020	C
5233	*	1105	C
5233	*	1190	C
5233	*	1275	C
5233	*	1360	C
5233	*	1445	C
5233	*	1530	C

551 GT Side indent

Tappeti modulari / Modular belts / Mattenketten

Belts wider than standard are available with 85 mm increments

551 GT Side indent Tappeto Modulare 551 GT, H=12,7 M=85 Modular Belt Series 551 GT, H=12,7 M=85 / Modulare Mattenkette 551 GT, H=12,7 M=85

CODE STRUCTURE GUIDE (Example)

Backflex radius min.: 50 mm

5235	01	0255	A
Series	*Material	Width	Version

25.4mm
PITCH

Metric Size

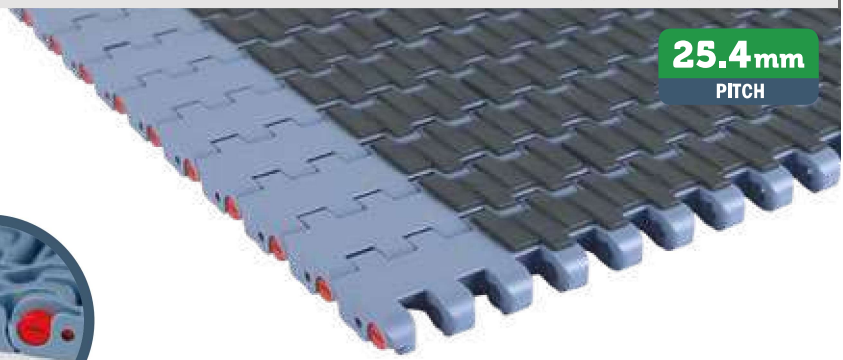
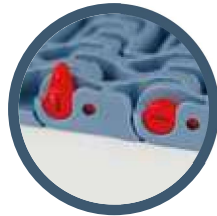
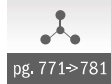

*Material

LFA - Code 01 Low friction Acetal

Easy Delivery

Max w. load: 41500 N/m
Weight: 13,5 kg/m²
Temp. range dry: -40+80 °C
Temp. range wet: -40+65 °C
Pin material: PBT white
Top rubber: 50 ShA-Dark grey

PP - Code 02 Polypropylene

Max w. load: 27000 N/m
Weight: 11,0 kg/m²
Temp. range dry: 4+80 °C
Temp. range wet: 4+80 °C
Pin material: PP blue
Top rubber: 50 ShA-Pigeon blue

MX - Code 03 Performance PBT

Max w. load: 33500 N/m
Weight: 12,7 kg/m²
Temp. range dry: -40+120 °C
Temp. range wet: -40+60 °C
Pin material: POM grey
Top rubber: 50 ShA-Dark grey

Version A - Standard

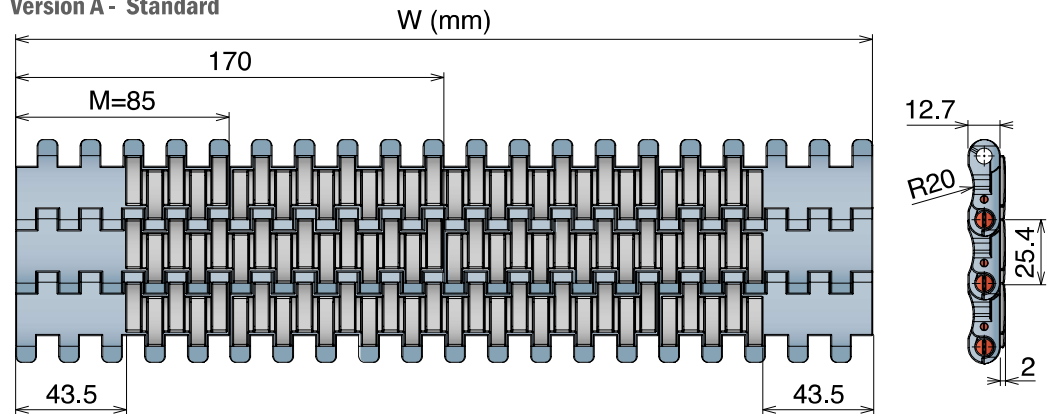

Version B - With 1 Positioner

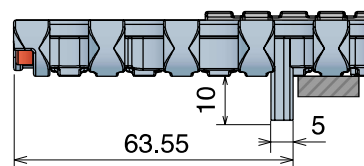

Version C - With 2 Positioner

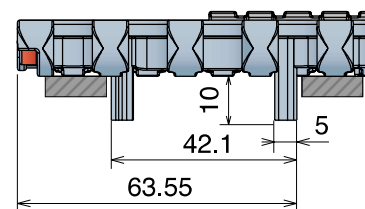

Version A - Standard

Series	Material	Width	Version
5235	*	0255	A
5235	*	0340	A
5235	*	0425	A
5235	*	0510	A
5235	*	0595	A
5235	*	0680	A
5235	*	0765	A
5235	*	0850	A
5235	*	0935	A
5235	*	1020	A
5235	*	1105	A
5235	*	1190	A
5235	*	1275	A
5235	*	1360	A
5235	*	1445	A
5235	*	1530	A

Version B - With 1 Positioner

Series	Material	Width	Version
5235	*	0255	B
5235	*	0340	B
5235	*	0425	B
5235	*	0510	B
5235	*	0595	B
5235	*	0680	B
5235	*	0765	B
5235	*	0850	B
5235	*	0935	B
5235	*	1020	B
5235	*	1105	B
5235	*	1190	B
5235	*	1275	B
5235	*	1360	B
5235	*	1445	B
5235	*	1530	B

Version C - With 2 Positioners

Series	Material	Width	Version
5235	*	0255	C
5235	*	0340	C
5235	*	0425	C
5235	*	0510	C
5235	*	0595	C
5235	*	0680	C
5235	*	0765	C
5235	*	0850	C
5235	*	0935	C
5235	*	1020	C
5235	*	1105	C
5235	*	1190	C
5235	*	1275	C
5235	*	1360	C
5235	*	1445	C
5235	*	1530	C

551 LBP

Tappeto Modulare 551 LBP, H=12,7 M=85
 Modular Belt Series 551 LBP, H=12,7 M=85 / Modulare Mattenkette 551 LBP, H=12,7 M=85

CODE STRUCTURE GUIDE (Example)

Backflex radius min.: 120 mm

5234	01	0085	A
Series	*Material	Width	Version

25.4mm
PITCH

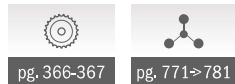

pg. 366-367

pg. 771>781

SAMPLE BOX

Art.-Nr. **5234018888A**

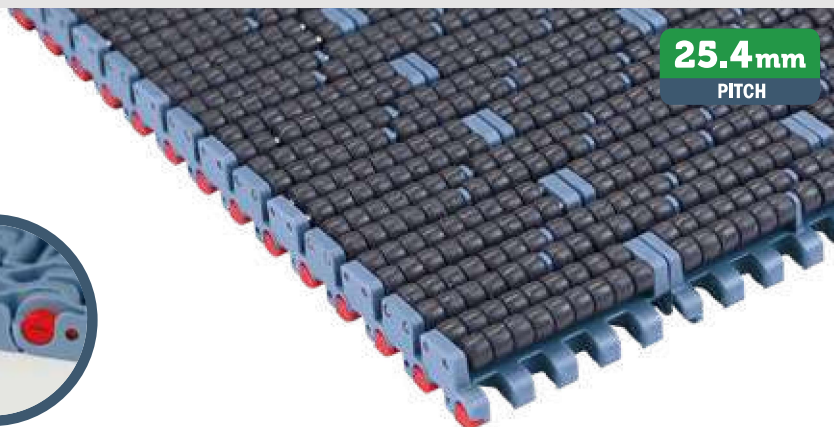

Metric Size

Material

LFA - Code 01

Low friction Acetal

Max w. load: 41500 N/m
 Weight: 26,9 kg/m²
 Temp. range dry: -40+80 °C
 Temp. range wet: -40+65 °C
 Pin material: PBT white

Version A - Standard

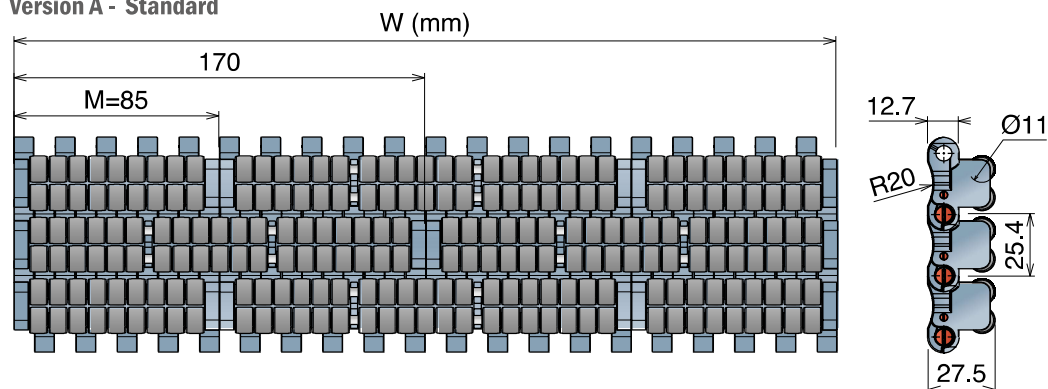

Version B - With 1 Positioner

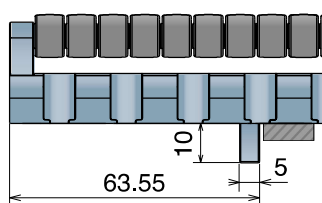

Version C - With 2 Positioners

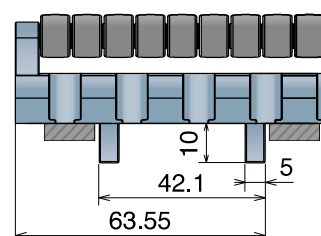

Version A - Standard

Series	Material	Width	Version
5234	01	0085	A
5234	01	0170	A
5234	01	0255	A
5234	01	0340	A
5234	01	0425	A
5234	01	0510	A
5234	01	0595	A
5234	01	0680	A
5234	01	0765	A
5234	01	0850	A
5234	01	0935	A
5234	01	1020	A
5234	01	1105	A
5234	01	1190	A
5234	01	1275	A
5234	01	1360	A
5234	01	1445	A
5234	01	1530	A

Version B - With 1 Positioner

Series	Material	Width	Version
5234	01	0085	B
5234	01	0170	B
5234	01	0255	B
5234	01	0340	B
5234	01	0425	B
5234	01	0510	B
5234	01	0595	B
5234	01	0680	B
5234	01	0765	B
5234	01	0850	B
5234	01	0935	B
5234	01	1020	B
5234	01	1105	B
5234	01	1190	B
5234	01	1275	B
5234	01	1360	B
5234	01	1445	B
5234	01	1530	B

Version C - With 2 Positioners

Series	Material	Width	Version
5234	01	0085	C
5234	01	0170	C
5234	01	0255	C
5234	01	0340	C
5234	01	0425	C
5234	01	0510	C
5234	01	0595	C
5234	01	0680	C
5234	01	0765	C
5234	01	0850	C
5234	01	0935	C
5234	01	1020	C
5234	01	1105	C
5234	01	1190	C
5234	01	1275	C
5234	01	1360	C
5234	01	1445	C
5234	01	1530	C

Metric Size

551 PRO LBP

Tappeto Modulare 551 PRO LBP, H=12,7 M=85

Modular Belt Series 551 PRO LBP, H=12,7 M=85 / Modulare Mattenkette 551 PRO LBP, H=12,7 M=85

CODE STRUCTURE GUIDE (Example)

Backflex radius min.: 100 mm

5240	01	0085	A
Series	*Material	Width	Version



pg. 366-367

pg. 771>781

SAMPLE BOX

Art.-Nr. **524001888A**



Material

LFA - Code 01

Low friction Acetal

Easy Delivery

Max w. load: 41500 N/m
 Weight SS pin: 13,8 kg/m²
 Weight Plastic pin: 11,0 kg/m²
 Temp. range dry: -40÷80 °C
 Temp. range wet: -40÷65 °C
 Pin material: PBT white

PFX Roller

**THE BEST CHOICE TO REACH
THE LOWEST FRICTION**

Version A - Standard

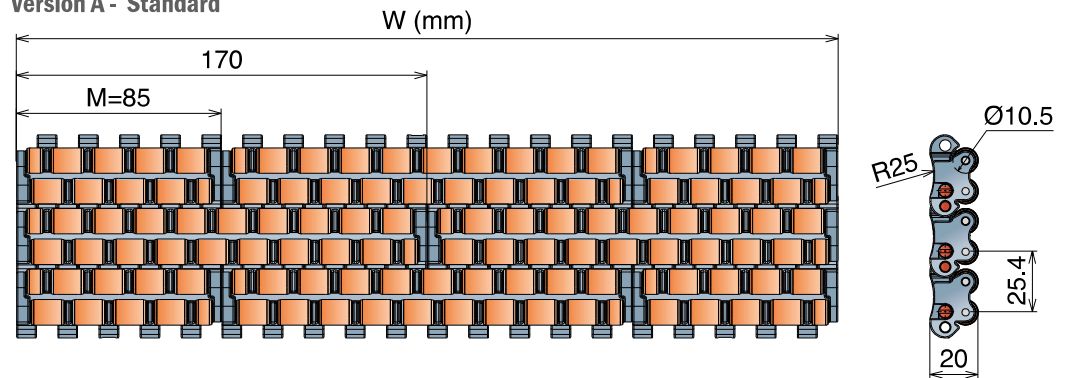

Version B - With 1 Positioner

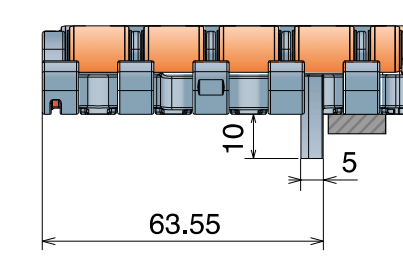

Version C - With 2 Positioner

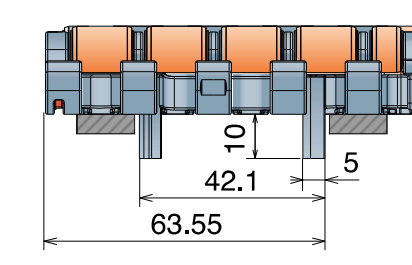

Stainless steel Pin

Series	Material	Width	Version
5239	01	0085	*
5239	01	0170	*
5239	01	0255	*
5239	01	0340	*
5239	01	0425	*
5239	01	0510	*
5239	01	0595	*
5239	01	0680	*
5239	01	0765	*
5239	01	0850	*
5239	01	0935	*
5239	01	1020	*
5239	01	1105	*
5239	01	1190	*
5239	01	1275	*
5239	01	1360	*
5239	01	1445	*
5239	01	1530	*

Plastic Pin

Series	Material	Width	Version
5240	01	0085	*
5240	01	0170	*
5240	01	0255	*
5240	01	0340	*
5240	01	0425	*
5240	01	0510	*
5240	01	0595	*
5240	01	0680	*
5240	01	0765	*
5240	01	0850	*
5240	01	0935	*
5240	01	1020	*
5240	01	1105	*
5240	01	1190	*
5240	01	1275	*
5240	01	1360	*
5240	01	1445	*
5240	01	1530	*

*Version

Standard	Add A
With 1 Positioner	Add B
With 2 Positioners	Add C

552

Pitch 25,4 mm

H= 12,7 mm



552 FT

552 FT *One track Belt*

552 FTT

552 PT

552 PT *One track Belt*

552 GT

552 GT *Side indent*

552 FT

Tappeto Modulare 552 FT, H=12,7 M=3"



Modular Belt Series 552 FT, H=12,7 M=3" / Modulare Mattenkette 552 FT, H=12,7 M=3"

CODE STRUCTURE GUIDE (Example)

Backflex radius min.: 25 mm

5341	01	0009	A
Series	*Material	Width	Version

25.4mm
PITCH

	
pg. 368	pg. 771>781

SAMPLE BOX

Art.-Nr. **534101888A**



*Material

LFA - Code 01

Low friction Acetal

Easy Delivery

Max w. load: 41500 N/m
Weight: 13,5 kg/m²
Temp. range dry: -40+80 °C
Temp. range wet: -40+65 °C
Pin material: PBT white

MX - Code 03

Performance PBT

Max w. load: 33500 N/m
Weight: 13,0 kg/m²
Temp. range dry: -40+120 °C
Temp. range wet: -40+60 °C
Pin material: POM grey

MWX - Code 17

Polyamide Composite

Max w. load: 41500 N/m
Weight: 14,0 kg/m²
Temp. range dry: -40+104 °C
Temp. range wet: NR
Pin material: PBT white

MPX - Code 25

Lubricated Acetal

Max w. load: 41500 N/m
Weight: 13,5 kg/m²
Temp. range dry: -40+80 °C
Temp. range wet: -40+65 °C
Pin material: PBT white

Version A - Standard

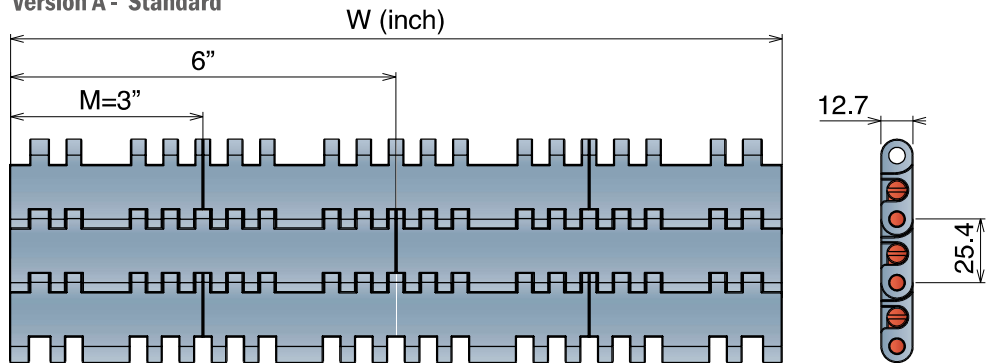

Version A - Standard

Series	Material	Width	Version
5341	*	0009	A
5341	*	0012	A
5341	*	0015	A
5341	*	0018	A
5341	*	0021	A
5341	*	0024	A
5341	*	0027	A
5341	*	0030	A
5341	*	0033	A
5341	*	0036	A
5341	*	0039	A
5341	*	0042	A
5341	*	0045	A
5341	*	0048	A
5341	*	0051	A
5341	*	0054	A

552 FT One track Belt

Tappeto Modulare 552 FT, H=12,7
Modular Belt Series 552 FT, H=12,7 / Modulare Mattenkette 552 FT, H=12,7

Imperial Size

CODE STRUCTURE GUIDE (Example)

Backflex radius min.: 25 mm

5341	01	0003	A
Series	*Material	Width	Version

25.4mm
PITCH

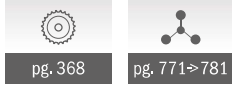
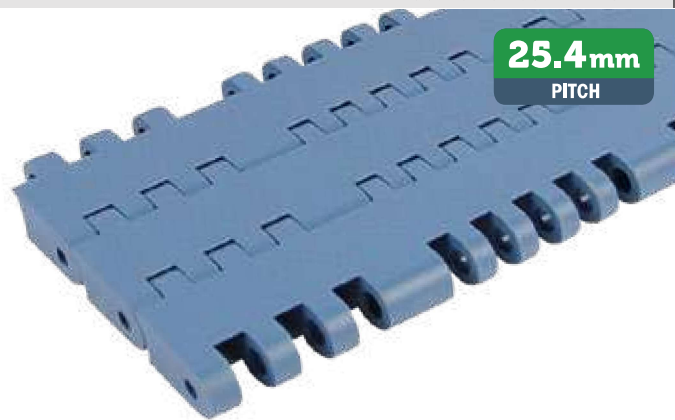

*Material

LFA - Code 01

Low friction Acetal

Easy Delivery

Max w. load: See below
Weight: 13,5 kg/m²
Temp. range dry: -40÷80 °C
Temp. range wet: -40÷65 °C
Pin material: PBT white

MX - Code 03

Performance PBT

Max w. load: See below
Weight: 13,0 kg/m²
Temp. range dry: -40÷120 °C
Temp. range wet: -40÷60 °C
Pin material: POM grey

MWX - Code 17

Polyamide Composite

Max w. load: See below
Weight: 14,0 kg/m²
Temp. range dry: -40÷104 °C
Temp. range wet: NR
Pin material: PBT white

MPX - Code 25

Lubricated Acetal

Max w. load: See below
Weight: 13,5 kg/m²
Temp. range dry: -40÷80 °C
Temp. range wet: -40÷65 °C
Pin material: PBT white

Version A - Standard

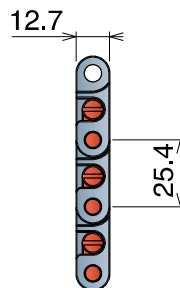
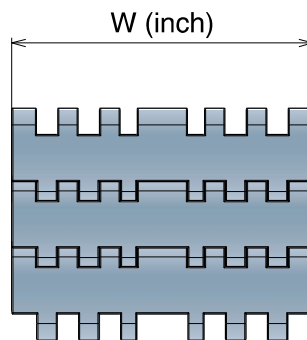

Version C - With 2 Positioner

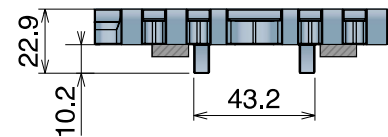

K300 - One track belt



K325 - One track belt



K450 - One track belt



Series	Material	Width	Version
5341	*	0003	A
5341	*	0003	C

Series	Material	Width	Version
5341	*	9325	A
5341	*	9325	C

Series	Material	Width	Version
5341	*	9450	A
5341	*	9450	C

Max working load (N)

Width	K300	K325	K450
LFA	3200	3400	4800
MX	2500	2800	3800
MWX	3200	3400	4800
MPX	3200	3400	4800

Width	K600	K750
LFA	6200	7900
MX	5100	6400
MWX	6200	7900
MPX	6200	7900

K600 - One track belt



Series	Material	Width	Version
5341	*	0006	A
5341	*	0006	C

K750 - One track belt



Series	Material	Width	Version
5341	*	9750	A
5341	*	9750	C

552 FTT



Tappeto Modulare 552 FTT, H=12,7
Modular Belt Series 552 FTT, H=12,7 / Modulare Mattenkette 552 FTT, H=12,7

CODE STRUCTURE GUIDE (Example)

Backflex radius min.: 25 mm

5346	01	9450	C-R
Series	*Material	Width	Version

25.4mm
PITCH

	
pg. 368	pg. 771>781

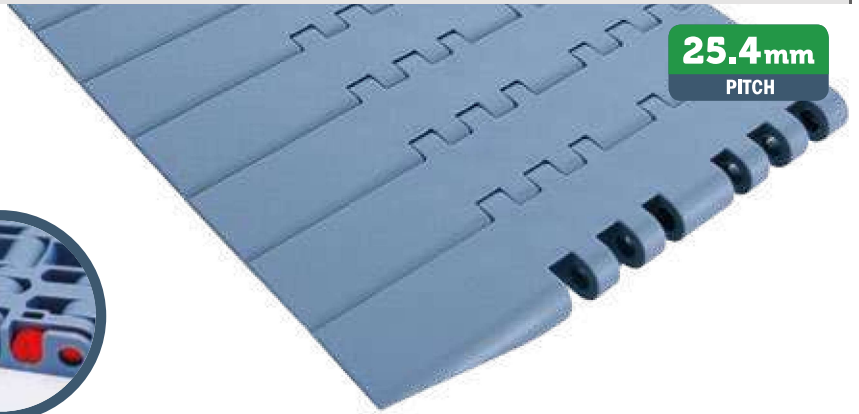

552 FTT - DX Version

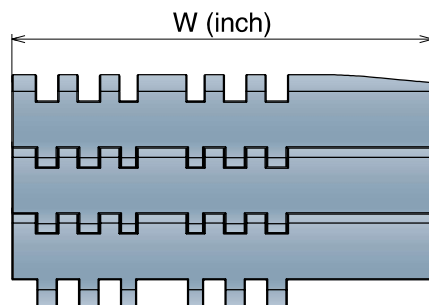
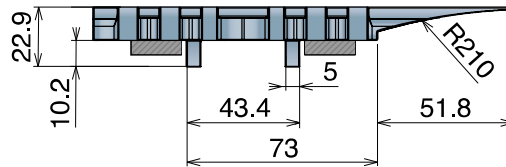

K450 / K750

Series	Material	Width	Version	Total width
5346	*	9450	C - R	160.3
5346	*	9750	C - R	237.4

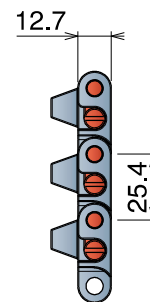

*Material

LFA - Code 01

Low friction Acetal

Max w. load: See below
Weight: 13,5 kg/m²
Temp. range dry: -40+80 °C
Temp. range wet: -40+65 °C
Pin material: PBT white

MX - Code 03

Performance PBT

Max w. load: See below
Weight: 13,0 kg/m²
Temp. range dry: -40+120 °C
Temp. range wet: -40+60 °C
Pin material: POM grey

MWX - Code 17

Polyamide Composite

Max w. load: See below
Weight: 14,0 kg/m²
Temp. range dry: -40+104 °C
Temp. range wet: NR
Pin material: PBT white

MPX - Code 25

Lubricated Acetal

Max w. load: See below
Weight: 13,5 kg/m²
Temp. range dry: -40+80 °C
Temp. range wet: -40+65 °C
Pin material: PBT white

Max working load (N)

Width	450	750
LFA	4800	7900
MX	3800	6400
MWX	4800	7900
MPX	4800	7900

552 FTT - SX Version

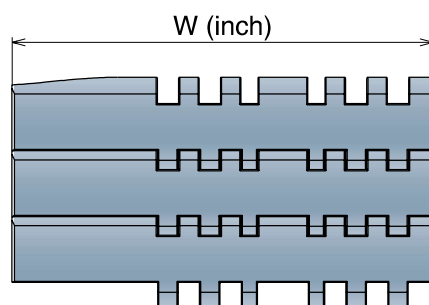
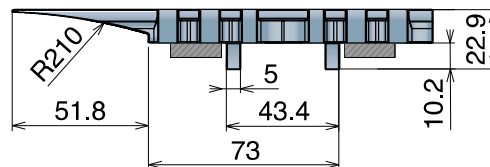

K450 / K750

Series	Material	Width	Version	Total width
5346	*	9450	C - L	160.3
5346	*	9750	C - L	237.4

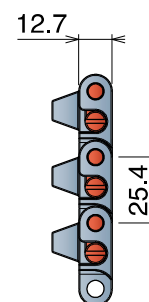

552 PT Open Surface 8% Tappeto Modulare 552 PT, H=12,7 M=3"

Modular Belt Series 552 PT, H=12,7 M=3" / Modulare Mattenkette 552 PT, H=12,7 M=3"

Imperial Size

CODE STRUCTURE GUIDE (Example)				Backflex radius min.: 25 mm
5342	01	0009	A	
Series	*Material	Width	Version	

pg. 368

pg. 771->781

SAMPLE BOX

Art.-Nr. **5342018888A**

***Material**

LFA - Code 01
Low friction Acetal

Max w. load: 41500 N/m
 Weight: 13,2 kg/m²
 Temp. range dry: -40÷80 °C
 Temp. range wet: -40÷65 °C
 Pin material: PBT white

MX - Code 03
Performance PBT

Max w. load: 33500 N/m
 Weight: 12,7 kg/m²
 Temp. range dry: -40÷120 °C
 Temp. range wet: -40÷60 °C
 Pin material: POM grey

MWX - Code 17
Polyamide Composite

Max w. load: 41500 N/m
 Weight: 13,7 kg/m²
 Temp. range dry: -40÷104 °C
 Temp. range wet: NR
 Pin material: PBT white

MPX - Code 25
Lubricated Acetal

Max w. load: 41500 N/m
 Weight: 13,2 kg/m²
 Temp. range dry: -40÷80 °C
 Temp. range wet: -40÷65 °C
 Pin material: PBT white

Version A - Standard

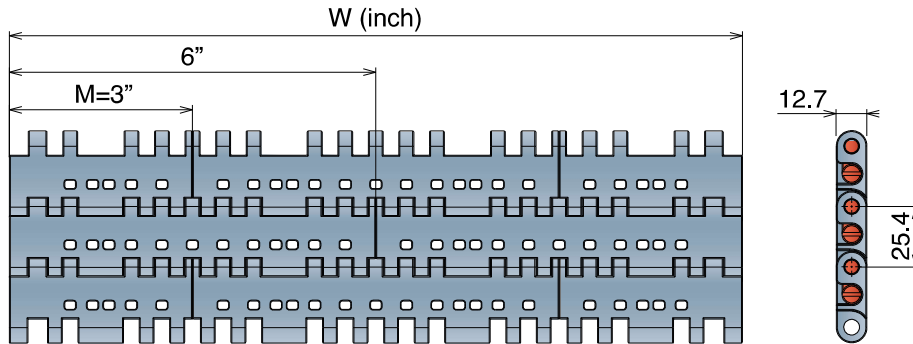

Version A - Standard

Series	Material	Width	Version
5342	*	0009	A
5342	*	0012	A
5342	*	0015	A
5342	*	0018	A
5342	*	0021	A
5342	*	0024	A
5342	*	0027	A
5342	*	0030	A
5342	*	0033	A
5342	*	0036	A
5342	*	0039	A
5342	*	0042	A
5342	*	0045	A
5342	*	0048	A
5342	*	0051	A
5342	*	0054	A

552 PT One track Belt

Tappeti modulari / Modular belts / Mattenketten

Imperial Size



552 PT One track Belt Open Surface 8% Tappeto Modulare 552 PT, H=12,7 M=3" Modular Belt Series 552 PT, H=12,7 M=3" / Modulare Mattenkette 552 PT, H=12,7 M=3"

CODE STRUCTURE GUIDE (Example)

Backflex radius min.: 25 mm

5342	01	0003	A
Series	*Material	Width	Version

25.4mm
PITCH

	
pg. 368	pg. 771>781

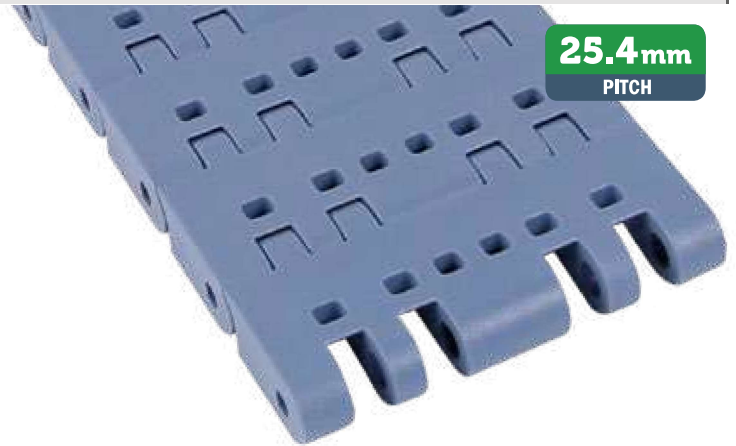

*Material

LFA - Code 01

Low friction Acetal

Max w. load: See below
Weight: 13,2 kg/m²
Temp. range dry: -40÷80 °C
Temp. range wet: -40÷65 °C
Pin material: PBT white

MX - Code 03

Performance PBT

Max w. load: See below
Weight: 12,7 kg/m²
Temp. range dry: -40÷120 °C
Temp. range wet: -40÷60 °C
Pin material: POM grey

MWX - Code 17

Polyamide Composite

Max w. load: See below
Weight: 13,7 kg/m²
Temp. range dry: -40÷104 °C
Temp. range wet: NR
Pin material: PBT white

MPX - Code 25

Lubricated Acetal

Max w. load: See below
Weight: 13,2 kg/m²
Temp. range dry: -40÷80 °C
Temp. range wet: -40÷65 °C
Pin material: PBT white

Max working load (N)

Width	300	600
LFA	3200	6300
MX	2500	5100
MWX	3200	6300
MPX	3200	6300

Version A - Standard

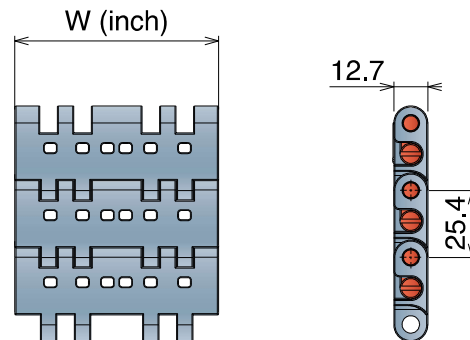

Version C - With 2 Positioner

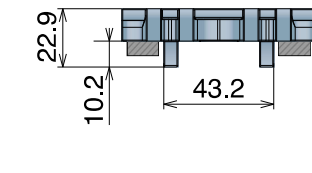

Version A - Standard

Series	Material	Width	Version
5342	*	0003	A
5342	*	0006	A

Version C - With 2 Positioners

Series	Material	Width	Version
5342	*	0003	C
5342	*	0006	C

Tappeti modulari / Modular belts / Mattenketten

552 GT

Tappeto Modulare 552 GT, H=12,7 M=3"
Modular Belt Series 552 GT, H=12,7 M=3" / Modulare Mattenkette 552 GT, H=12,7 M=3"

Imperial Size

CODE STRUCTURE GUIDE (Example)

Backflex radius min.: 25 mm

5343	01	0009	A
Series	*Material	Width	Version

25.4mm
PITCH

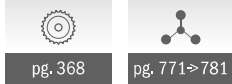

pg. 368

pg. 771>781

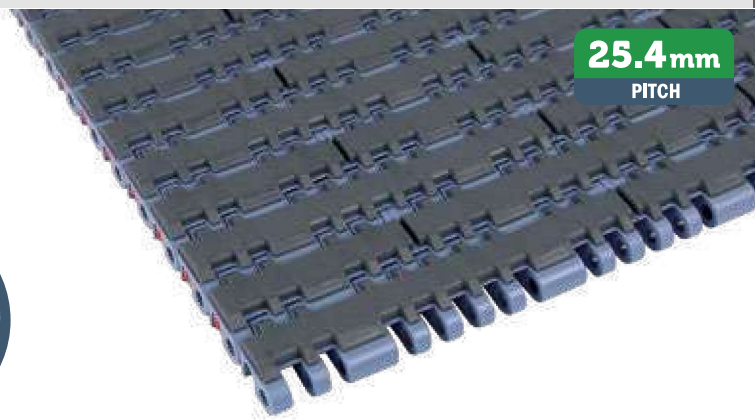

*Material

LFA - Code 01

Low friction Acetal

Max w. load: 41500 N/m
Weight: 15,5 kg/m²
Temp. range dry: -40÷80 °C
Temp. range wet: -40÷65 °C
Pin material: PBT white
Top rubber: 50 ShA-Dark grey

PP - Code 02

Polypropylene

Max w. load: 27000 N/m
Weight: 13,5 kg/m²
Temp. range dry: 4÷80 °C
Temp. range wet: 4÷80 °C
Pin material: PP blue
Top rubber: 50 ShA-Black

Version A - Standard

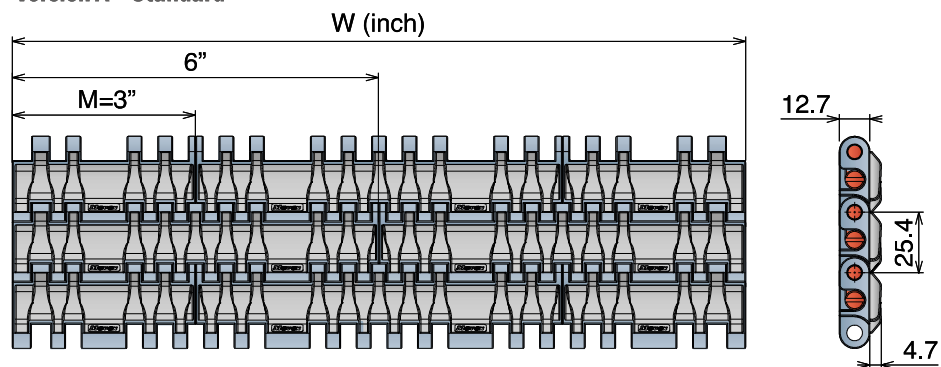

Plastic Pin

See the material table above

Series	Material	Width	Version
5343	*	0009	A
5343	*	0012	A
5343	*	0015	A
5343	*	0018	A
5343	*	0021	A
5343	*	0024	A
5343	*	0027	A
5343	*	0030	A
5343	*	0033	A
5343	*	0036	A
5343	*	0039	A
5343	*	0042	A
5343	*	0045	A
5343	*	0048	A
5343	*	0051	A
5343	*	0054	A

Stainless steel Pin

AISI 304

Series	Material	Width	Version
5343	01	0012	A-SS
5343	01	0015	A-SS
5343	01	0018	A-SS
5343	01	0021	AS-S

With the SS pin version, these values increase:

Max w. load: 45000 N/m
Weight: LFA belt: 22,9 kg/m²
PP belt: 18,9 kg/m²



Rubber Thickness 4.7 mm

552 GT Side indent

Tappeti modulari / Modular belts / Mattenketten



Belts wider than standard are available with 3 inch increments

552 GT Side indent Tappeto Modulare 552 GT SI, H=12,7 M=3" Modular Belt Series 552 GT SI, H=12,7 M=3" / Modulare Mattenkette 552 GT SI, H=12,7 M=3"

CODE STRUCTURE GUIDE (Example)

Backflex radius min.: 25 mm

5345	01	0009	A
Series	*Material	Width	Version

	
pg. 368	pg. 771>781

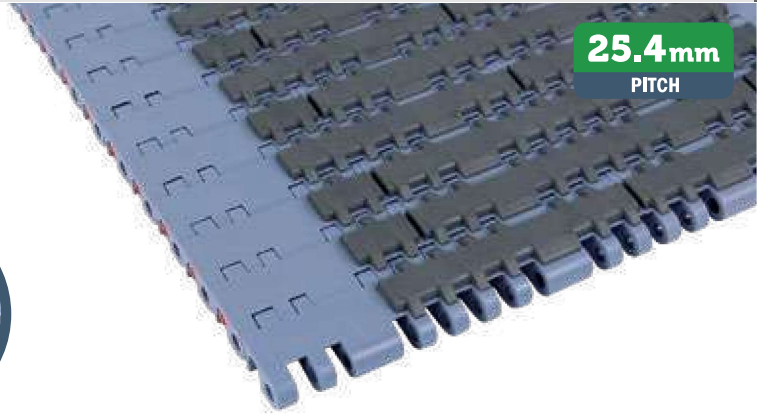

25.4mm
PITCH



Imperial Size

*Material

LFA - Code 01

Low friction Acetal

Max w. load: 41500 N/m
Weight: 15,5 kg/m²
Temp. range dry: -40+80 °C
Temp. range wet: -40+65 °C
Pin material: PBT white
Top rubber: 50 ShA-Dark grey

PP - Code 02

Polypropylene

Max w. load: 27000 N/m
Weight: 13,5 kg/m²
Temp. range dry: 4+80 °C
Temp. range wet: 4+80 °C
Pin material: PP blue
Top rubber: 50 ShA-Black

Version A - Standard

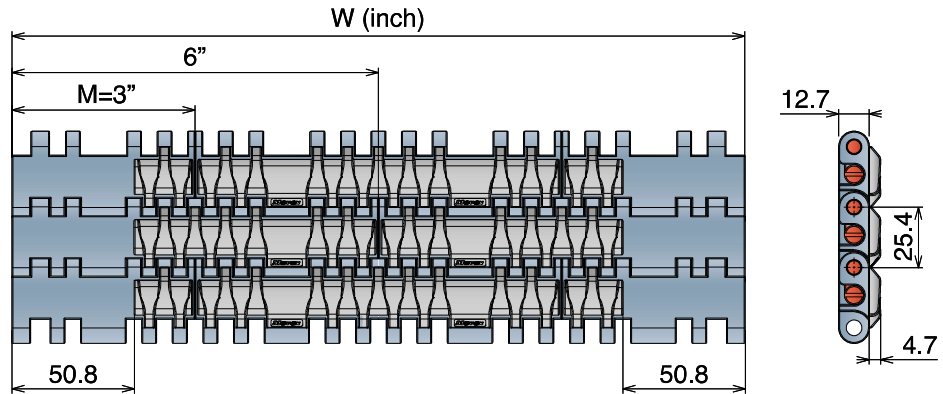

Plastic Pin

See the material table above

Series	Material	Width	Version
5345	*	0009	A
5345	*	0012	A
5345	*	0015	A
5345	*	0018	A
5345	*	0021	A
5345	*	0024	A
5345	*	0027	A
5345	*	0030	A
5345	*	0033	A
5345	*	0036	A
5345	*	0039	A
5345	*	0042	A
5345	*	0045	A
5345	*	0048	A
5345	*	0051	A
5345	*	0054	A

Stainless steel Pin

AISI 304

Series	Material	Width	Version
5345	01	0012	A-SS
5345	01	0015	A-SS
5345	01	0018	A-SS
5345	01	0021	A-SS

With the SS pin version, these values increase:

Max w. load: 45000 N/m
Weight: LFA belt: 22,9 kg/m²
PP belt: 18,9 kg/m²



Rubber Thickness 4.7 mm

553 Series

553

Pitch 25,4 mm

H= 8,7 mm

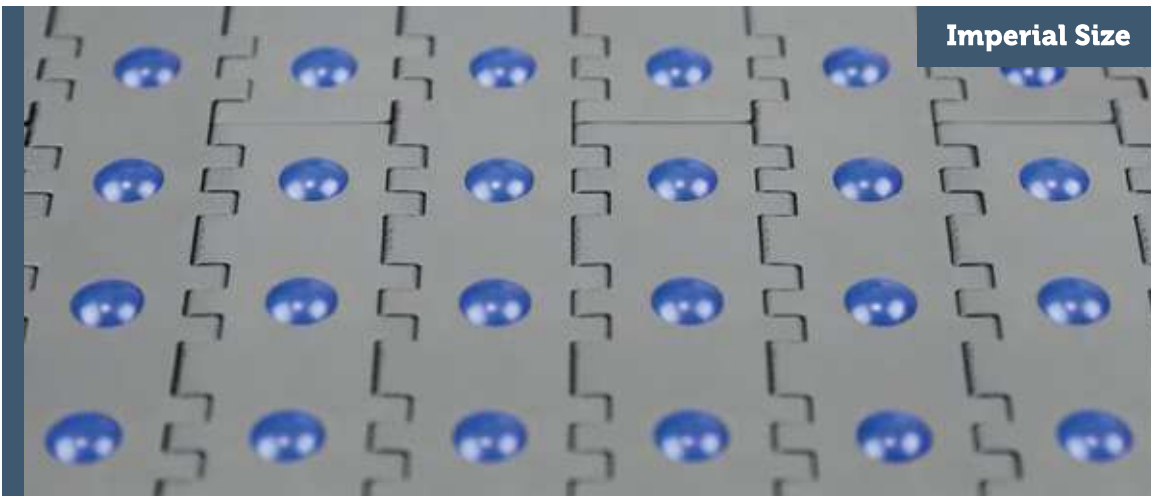

553 FLEXTOP

Movex[®]

553 FLEX TOP Tappeto Modulare 553 FLEXTOP, H=8,7 M=3"

Modular Belt Series 553 FLEXTOP, H=8,7 M=3" / Modulare Mattenkette 553 FLEXTOP, H=8,7 M=3"

Backflex radius min.: 25 mm

The new **Movex® 553 FlexTop** modular belt with self-locking spheres is specifically designed for high-precision material handling, suitable for several applications like logistic centers, packaging stations (food and beverage) and corrugated industries, easily to be integrated into existing systems. The 360° movement possibility makes the belt suitable for diverting, rotation, accumulation and acceleration applications and minimize required maintenance and downtimes. The small pitch between the spheres allows every type of product transfer and is ideal for small and light packages, unlike traditional roller conveyors.

The complete closed sliding belt surface is the perfect solution to carry carton boxes, crates, cans and bottles shrink-wrap packaging and any kind of polybag with Top-Accuracy package control. **553 FlexTop is best choice for material handling applications!**

High strength

Design and features of 553 FlexTop make it ideal for the transport of several type of products (e.g. polybags, shrink-wrap packaging).

Perfect product control

The small pitch between the spheres allows for a great product-control.

Self cleaning

A complete closed sliding surface, in combination with self-locking spheres, makes the belt design flexible and robust.

Great versatility

The directional belt underneath the flextop belt controls the direction and the speed of the spheres, making this belt 100% versatile.

Long durability

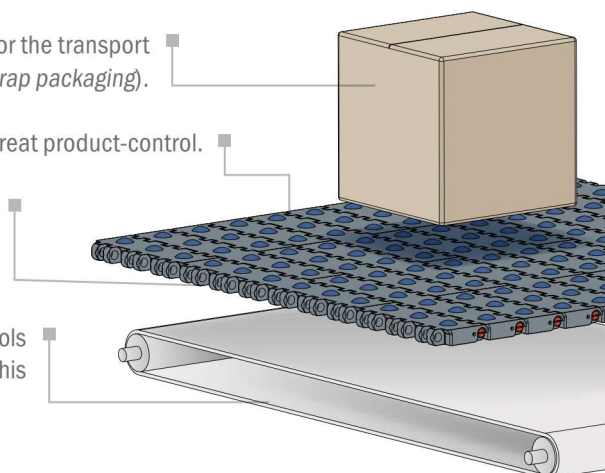

DIVERTING

Side movement

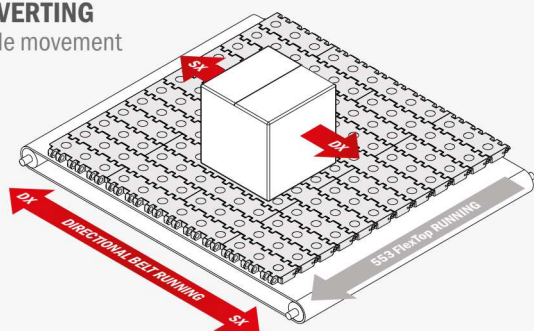

By using a directional belt underneath the Flextop belt, running square to the travel direction, the product can be transferred left and right.

ROTATION

Product stop

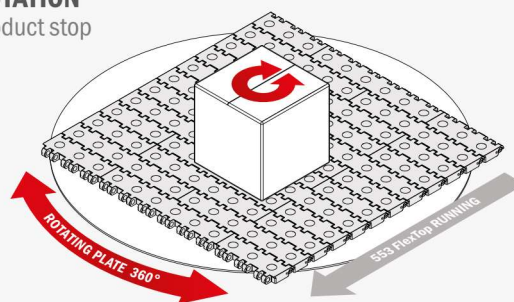

By using a rotating plate underneath the Flextop belt, sphere can rotate by 360°. This option can be used with product stopped or running on the belt, to easily positioning the product.

DINAMIC ROTATION

Product moving

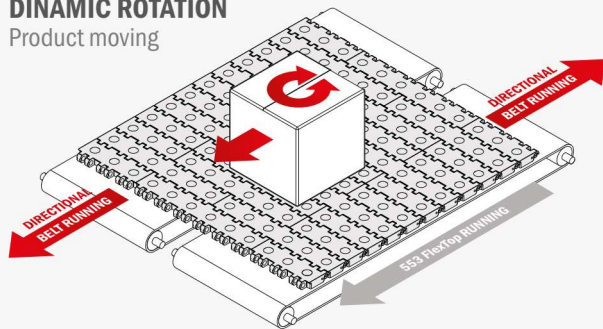

By using two auxiliary belts underneath the Flextop belt, running at opposite direction, the product will start rotating. With this option the Flextop belt can keep running.

ACCELERATION

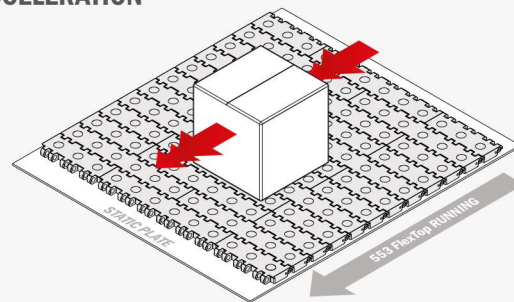

By using a static plate underneath the Flextop belt, spheres will start rotating independently, so the speed of the product will result double than the speed of the belt itself.

PATENTED

Belts wider than standard are available with 3 inch increments

553 FLEX TOP



Tappeti modulari / Modular belts / Mattenketten

553 FLEX TOP Tappeto Modulare 553 FLEXTOP, H=8,7 M=3" / Modular Belt Series 553 FLEXTOP, H=8,7 M=3" / Modulare Mattenkette 553 FLEXTOP, H=8,7 M=3"

CODE STRUCTURE GUIDE (Example)

Backflex radius min.: 25 mm

5530	27	0003	A
Series	*Material	Width	Version

		
pg. 369	553 Sorter + pg. 341>344	pg. 771>781

SAMPLE BOX

Art.-Nr. **553027888A**



Imperial Size

*Material

LFG - Code 27

Low friction Acetal

Max w. load: 27500 N/m
 Weight: 10,0 kg/m²
 Temp. range dry: -40+80 °C
 Temp. range wet: -40+65 °C
 Pin material: PBT white

Sphere Material

High-tech polyamide

Max w. load: 15 N
 Sphere diameter: 12,7 mm

Version A - Standard

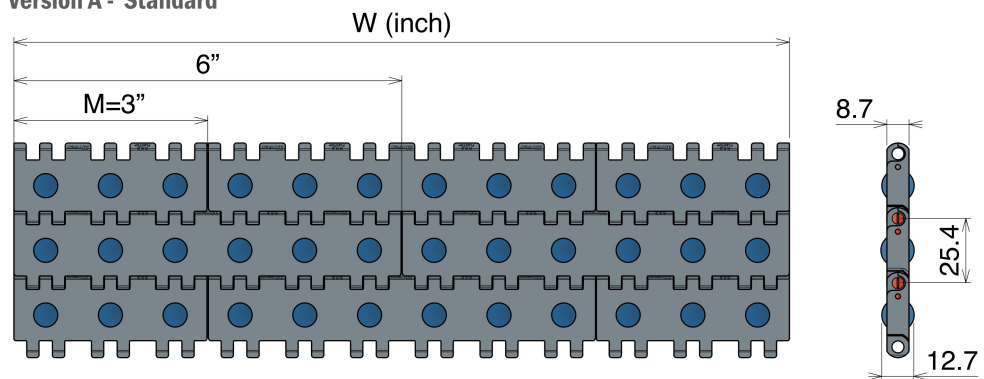

Version A - Standard

Series	Material	Width	Version	Series	Material	Width	Version
5530	27	0003	A	5530	27	0060	A
5530	27	0006	A	5530	27	0063	A
5530	27	0009	A	5530	27	0066	A
5530	27	0012	A	5530	27	0069	A
5530	27	0015	A	5530	27	0072	A
5530	27	0018	A	5530	27	0075	A
5530	27	0021	A	5530	27	0078	A
5530	27	0024	A	5530	27	0081	A
5530	27	0027	A	5530	27	0084	A
5530	27	0030	A	5530	27	0087	A
5530	27	0033	A	5530	27	0090	A
5530	27	0036	A	5530	27	0093	A
5530	27	0039	A	5530	27	0096	A
5530	27	0042	A	5530	27	0099	A
5530	27	0045	A	5530	27	0102	A
5530	27	0048	A	5530	27	0105	A
5530	27	0051	A	5530	27	0108	A
5530	27	0054	A	5530	27	0111	A
5530	27	0057	A	5530	27	0114	A



**PATENTED
CLOSED GAP**

Patented closed gap helps reducing maintenance frequency and increasing productivity.

Used with Part 236 & 237
Page 443

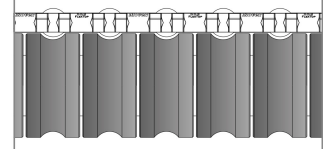

Continue >>

556 Series

556

Pitch 25,4 mm
H= 12,7 mm



556 FT
556 GT

Movex®

556 FT

Open Surface 25% Tappeto Modulare Curvilineo Serie 556 FT, H=12,7 M=3"
Side Flex Modular Belt Series 556 FT, H=12,7 M=3" / Kurvengängige Mattenkette Serie 556 FT, H=12,7 M=3"

Imperial Size

CODE STRUCTURE GUIDE (Example)			
5431	01	0009	A
Series	*Material	Width	Version

Backflex radius min.: 25 mm

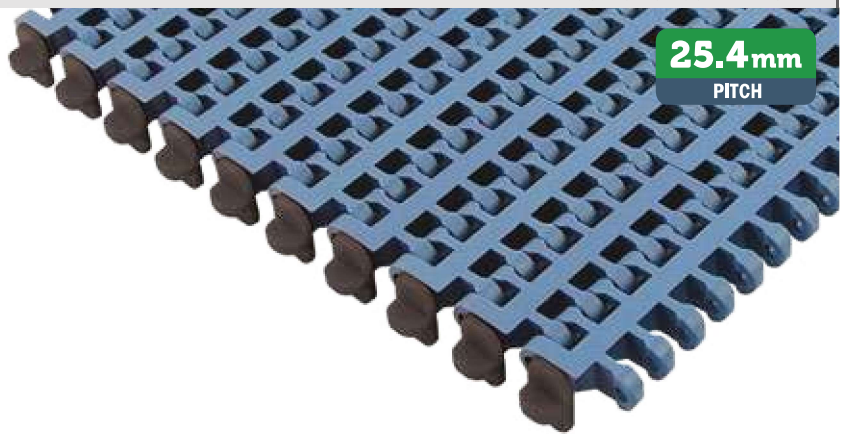

25.4mm
PITCH

pg. 370

pg. 771>781

***Material**

LFA - Code 01
Low friction Acetal

Max w. load:
Straight: 30000 N/m
Curve: 2000 N

Weight: 7,5 kg/m²

Temp. range dry: -40÷80 °C
Temp. range wet: -40÷65 °C

Pin material: PBT white

LFB - Code 23
Low friction Acetal

Max w. load:
Straight: 30000 N/m
Curve: 2000 N

Weight: 7,5 kg/m²

Temp. range dry: -40÷80 °C
Temp. range wet: -40÷65 °C

Pin material: PBT white

PPB - Code 24
Polypropylene

Max w. load:
Straight: 19500 N/m
Curve: 1300 N

Weight: 5,8 kg/m²

Temp. range dry: 4÷104 °C
Temp. range wet: 4÷104 °C

Pin material: PP blu

THE BEST CHOICE FOR FOOD CONTACT APPLICATION

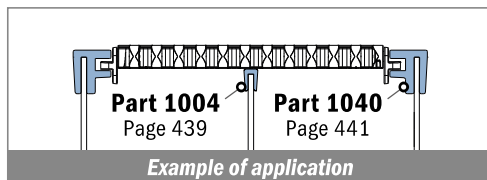
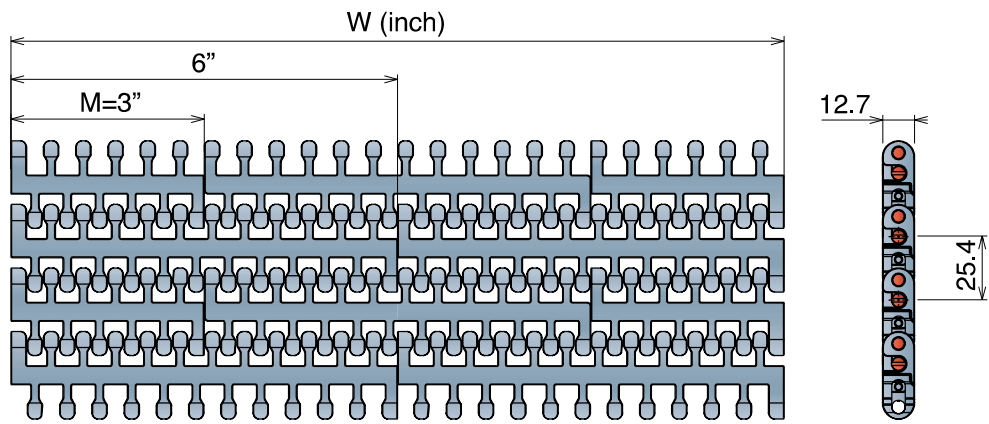

STANDARD				
Series	Material	Width	Version	min radius
5431	*	0003	A	145
5431	*	0006	A	290
5431	*	0009	A	435
5431	*	0012	A	580
5431	*	0015	A	725
5431	*	0018	A	890
5431	*	0021	A	1040
5431	*	0024	A	1250

TAB				
Series	Material	Width	Version	min radius
5431	*	0003	B	145
5431	*	0006	B	290
5431	*	0009	B	435
5431	*	0012	B	580
5431	*	0015	B	725
5431	*	0018	B	890
5431	*	0021	B	1040
5431	*	0024	B	1250

TAB/POSITIONER				
Series	Material	Width	Version	min radius
5431	*	0003	C	145
5431	*	0006	C	290
5431	*	0009	C	435
5431	*	0012	C	580
5431	*	0015	C	725
5431	*	0018	C	890
5431	*	0021	C	1040
5431	*	0024	C	1250

NEW TAB-S				
Series	Material	Width	Version	min radius
5431	*	0003	D	145
5431	*	0006	D	290
5431	*	0009	D	435
5431	*	0012	D	580
5431	*	0015	D	725
5431	*	0018	D	890
5431	*	0021	D	1040
5431	*	0024	D	1250

556 GT Open Surface 25% Tappeto Modulare Curvilineo Serie 556 GT, H=12,7 M=3"

Side Flex Modular Belt Series 556 GT, H=12,7 M=3" / Kurvengängige Mattenkette Serie 556 GT, H=12,7 M=3"

CODE STRUCTURE GUIDE (Example)

Backflex radius min.: 25 mm

5433	01	0009	A
Series	*Material	Width	Version

25.4mm
PITCH



Imperial Size



pg. 370



pg. 771>781

*Material

LFA - Code 01

Low friction Acetal

Max w. load:

Straight: 30000 N/m

Curve: 2000 N

Weight: 7,7 kg/m²

Temp. range dry: -40+80 °C

Temp. range wet: -40+65 °C

Pin material: PBT white

Top rubber: 50 ShA-Dark grey

LFB - Code 23

Low friction Acetal

Max w. load:

Straight: 30000 N/m

Curve: 2000 N

Weight: 7,7 kg/m²

Temp. range dry: -40+80 °C

Temp. range wet: -40+65 °C

Pin material: PBT white

Top rubber: 50 ShA-Black

PPB - Code 24

Polypropylene

Max w. load:

Straight: 19500 N/m

Curve: 1300 N

Weight: 6,0 kg/m²

Temp. range dry: 4+104 °C

Temp. range wet: 4+104 °C

Pin material: PP blu

Top rubber: 50 ShA-Black

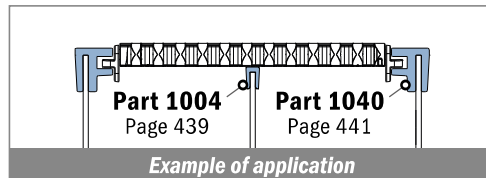
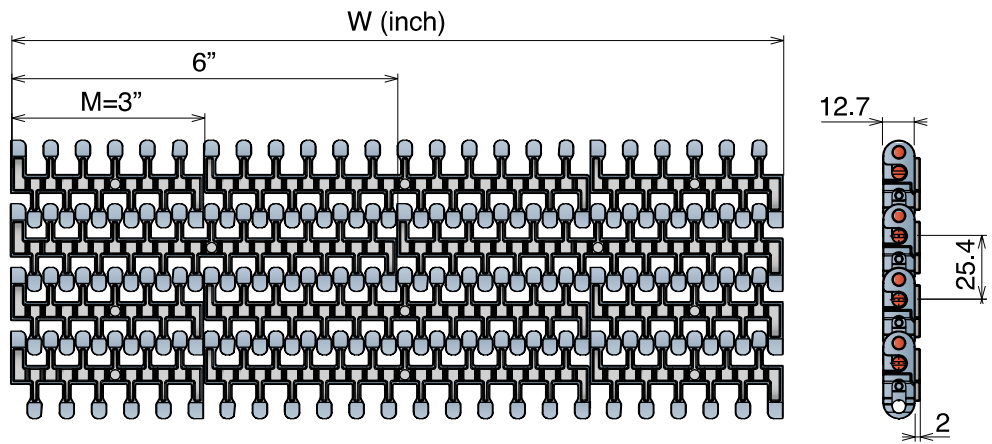

STANDARD

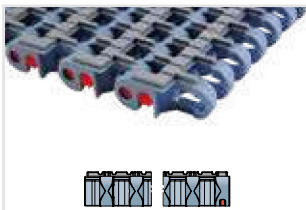

Series	Material	Width	Version	min radius
5433	*	0003	A	145
5433	*	0006	A	290
5433	*	0009	A	435
5433	*	0012	A	580
5433	*	0015	A	725
5433	*	0018	A	890
5433	*	0021	A	1040
5433	*	0024	A	1250

TAB

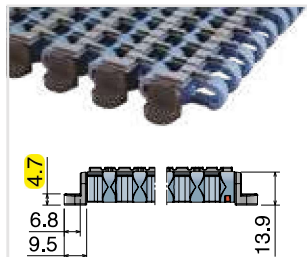

Series	Material	Width	Version	min radius
5433	*	0003	B	145
5433	*	0006	B	290
5433	*	0009	B	435
5433	*	0012	B	580
5433	*	0015	B	725
5433	*	0018	B	890
5433	*	0021	B	1040
5433	*	0024	B	1250

TAB/POSITIONER

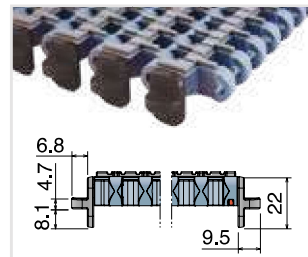

Series	Material	Width	Version	min radius
5433	*	0003	C	145
5433	*	0006	C	290
5433	*	0009	C	435
5433	*	0012	C	580
5433	*	0015	C	725
5433	*	0018	C	890
5433	*	0021	C	1040
5433	*	0024	C	1250

NEW

TAB-S

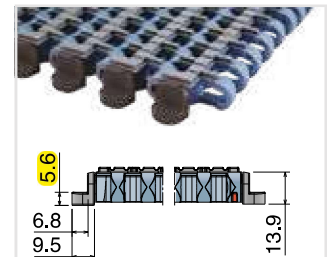

Series	Material	Width	Version	min radius
5433	*	0003	D	145
5433	*	0006	D	290
5433	*	0009	D	435
5433	*	0012	D	580
5433	*	0015	D	725
5433	*	0018	D	890
5433	*	0021	D	1040
5433	*	0024	D	1250

600

Pitch 31,75 mm

H= 12,7 mm



600 Standard

600 Heavy duty

**600 Heavy duty
with Bearings**

600 Small radius

600 Heavy duty/Small radius

**600 Heavy duty/Small radius
with Bearings**

600 with pusher

600 Machined profiles

Metric Size

600 Standard

Tappeto Modulare Curvilineo Serie 600, H=12,7 M=85

Side Flex Modular Belt Series 600, H=12,7 M=85 / Kurvengängige Mattenkette Serie 600, H=12,7 M=85

CODE STRUCTURE GUIDE (Example)

Backflex radius min.: 25 mm

5421	01	0255	A
Series	*Material	Width	Version

29.5%
OPEN SURFACE

31.75mm
PITCH

		
pg. 373	pg. 178/179	pg. 771>781



*Material

LFA - Code 01

Low friction Acetal

Max w. load:

Straight 30000 N/m
Curve 2500 N

Weight: 7,7 kg/m²

Temp. range dry: -40+80 °C

Temp. range wet: -40+65 °C

Pin material: PBT white

LFB - Code 23

Low friction Acetal

Max w. load:

Straight 30000 N/m
Curve 2500 N

Weight: 7,7 kg/m²

Temp. range dry: -40+80 °C

Temp. range wet: -40+65 °C

Pin material: PBT white

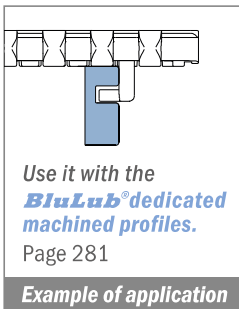

Internal Min Radius
2 times the width

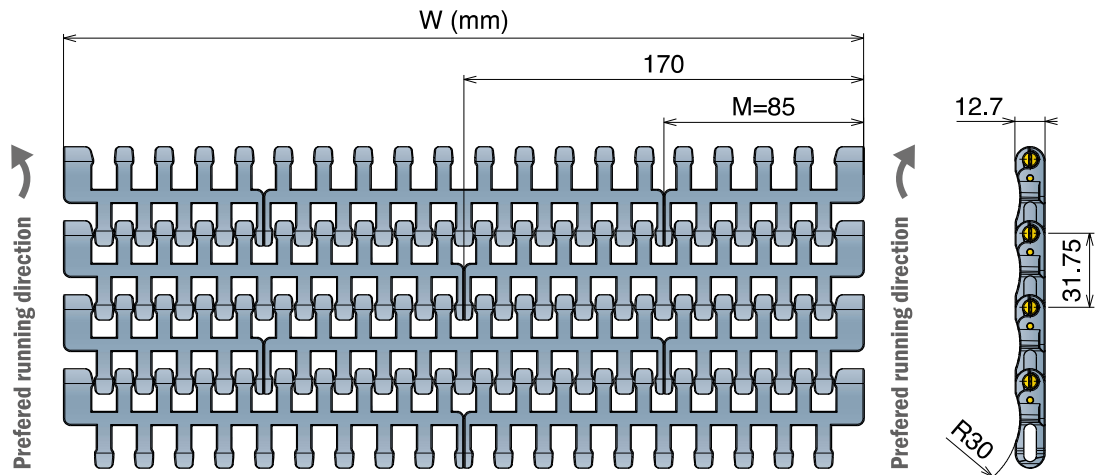

STANDARD



TAB

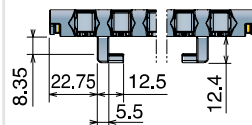

REVERSE TAB

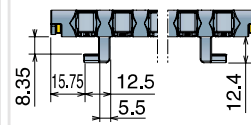

TAB REVERSE TAB

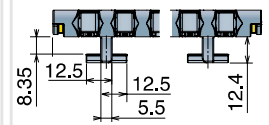

Series	Material	Width	Version	min radius
5421	*	0255	A	510
5421	*	0340	A	680
5421	*	0425	A	850
5421	*	0510	A	1020
5421	*	0595	A	1190
5421	*	0680	A	1360
5421	*	0765	A	1530
5421	*	0850	A	1700
5421	*	0255	B	510
5421	*	0340	B	680
5421	*	0425	B	850
5421	*	0510	B	1020
5421	*	0595	B	1190
5421	*	0680	B	1360
5421	*	0765	B	1530
5421	*	0850	B	1700
5421	*	0255	C	510
5421	*	0340	C	680
5421	*	0425	C	850
5421	*	0510	C	1020
5421	*	0595	C	1190
5421	*	0680	C	1360
5421	*	0765	C	1530
5421	*	0850	C	1700
5421	*	0255	D	510
5421	*	0340	D	680
5421	*	0425	D	850
5421	*	0510	D	1020
5421	*	0595	D	1190
5421	*	0680	D	1360
5421	*	0765	D	1530
5421	*	0850	D	1700

600 Heavy duty

Tappeto Modulare Curvilineo Serie 600, H=12,7 M=85
 Side Flex Modular Belt Series 600, H=12,7 M=85 / Kurvengängige Mattenkette Serie 600, H=12,7 M=85

CODE STRUCTURE GUIDE (Example)

Backflex radius min.: 25 mm

5422	01	0255	E
Series	*Material	Width	Version

27.5%
OPEN SURFACE

31.75mm
PITCH

		
pg. 373	pg. 180	pg. 771>781

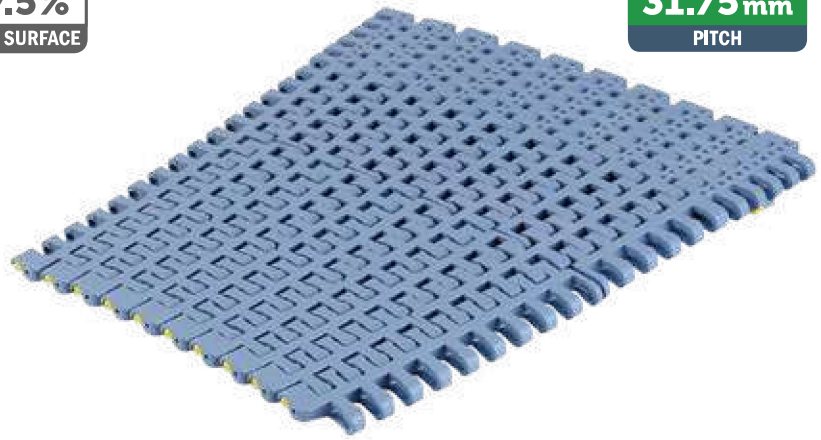

Metric Size

***Material**

LFA - Code 01

Low friction Acetal

Max w. load:
 Straight 30000 N/m
 Curve 3500 N
Weight: 8,3 kg/m²
Temp. range dry: -40÷80 °C
Temp. range wet: -40÷65 °C
Pin material: PBT white

LFB - Code 23

Low friction Acetal

Max w. load:
 Straight 30000 N/m
 Curve 3500 N
Weight: 8,3 kg/m²
Temp. range dry: -40÷80 °C
Temp. range wet: -40÷65 °C
Pin material: PBT white

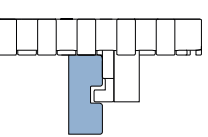

Use it with the **BluLub®** dedicated machined profiles.
 Page 281
 Example of application

Internal Min Radius
2 times the width

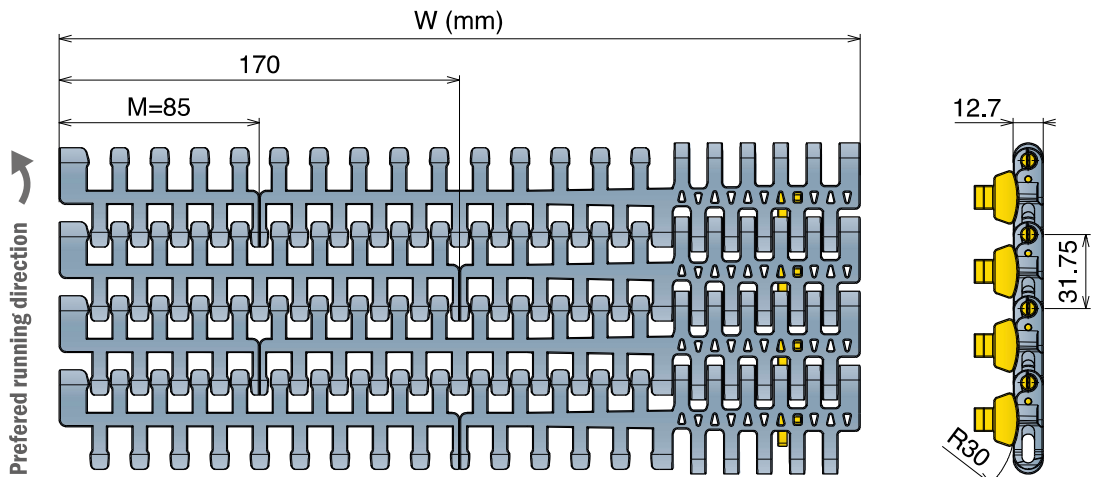

STANDARD

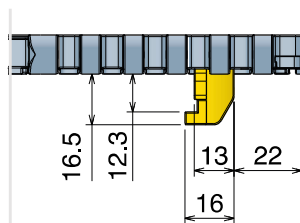

Series	Material	Width	Version	min radius
5422	*	0255	E	510
5422	*	0340	E	680
5422	*	0425	E	850
5422	*	0510	E	1020
5422	*	0595	E	1190
5422	*	0680	E	1360
5422	*	0765	E	1530
5422	*	0850	E	1700

TAB DKM Material



600 Heavy duty with Bearings

Tappeti modulari / Modular belts / Mattenketten

Belts wider than standard are available with 85 mm increments

Metric Size

600 Heavy duty with Bearings

Tappeto Modulare Curvilineo Serie 600, H=12,7 M=85
Side Flex Modular Belt Series 600, H=12,7 M=85 / Kurvengängige Mattenkette Serie 600, H=12,7 M=85

CODE STRUCTURE GUIDE (Example)

Backflex radius min.: 25 mm

5422	01	0340	F
Series	*Material	Width	Version

27.5%
OPEN SURFACE

31.75 mm
PITCH

		
pg. 373	pg. 181	pg. 771>781

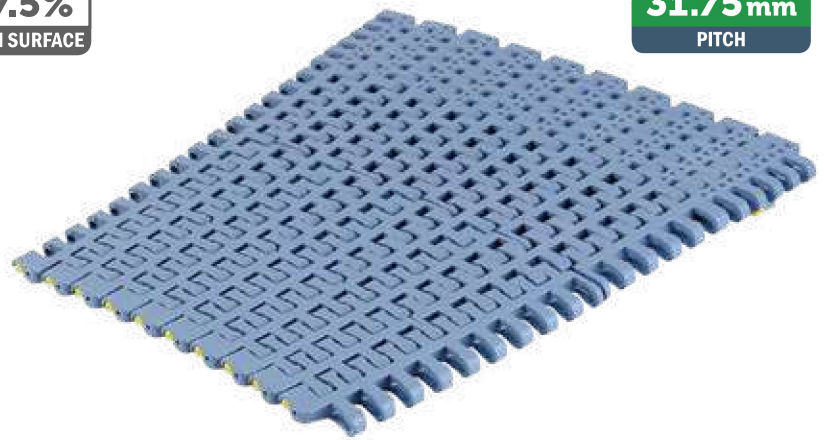

*Material

LFA - Code 01

Low friction Acetal

Max w. load:

Straight 30000 N/m
Curve 3500 N

Weight: 9,0 kg/m²

Temp. range dry: -40+80 °C

Temp. range wet: -40+65 °C

Pin material: PBT white

LFB - Code 23

Low friction Acetal

Max w. load:

Straight 30000 N/m
Curve 3500 N

Weight: 9,0 kg/m²

Temp. range dry: -40+80 °C

Temp. range wet: -40+65 °C

Pin material: PBT white

Internal Min Radius
2 times the width

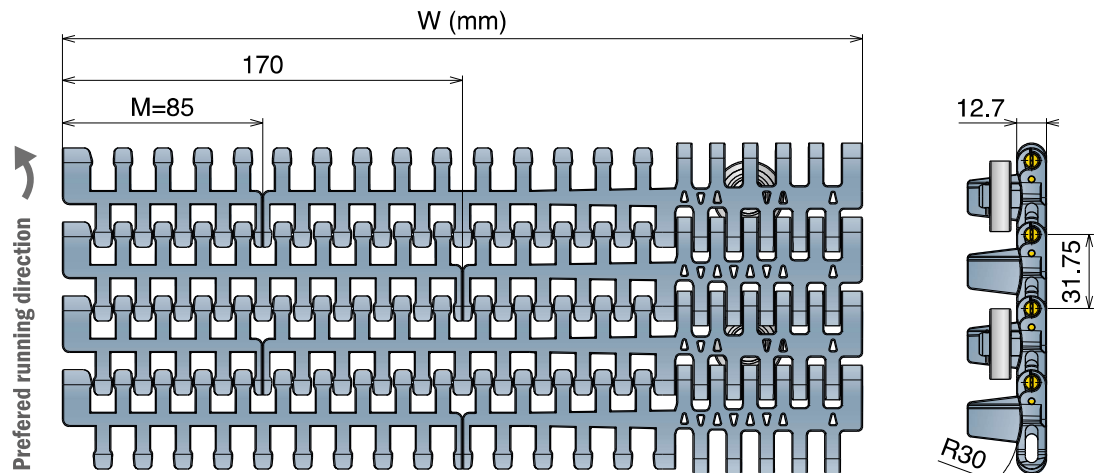
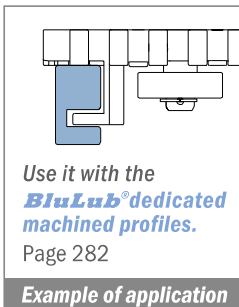

STANDARD

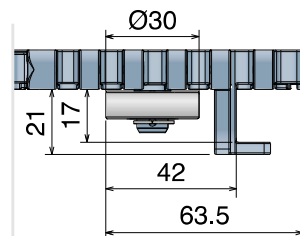

Series	Material	Width	Version	min radius
5422	*	0255	F	510
5422	*	0340	F	680
5422	*	0425	F	850
5422	*	0510	F	1020
5422	*	0595	F	1190
5422	*	0680	F	1360
5422	*	0765	F	1530
5422	*	0850	F	1700

Bearing Zoom



Tappeti modulari / Modular belts / Mattenketten

600 Small radius

Tappeto Modulare Curvilineo Serie 600, H=12,7 M=85
Side Flex Modular Belt Series 600, H=12,7 M=85 / Kurvengängige Mattenkette Serie 600, H=12,7 M=85

CODE STRUCTURE GUIDE (Example)

Backflex radius min.: 25 mm

5423	01	0340	A
Series	*Material	Width	Version

29.5%
OPEN SURFACE

31.75 mm
PITCH

		
pg. 373-374	pg. 178/179	pg. 771>781



*Material

LFA - Code 01

Low friction Acetal

Max w. load:

Straight 30000 N/m
Curve 2500 N

Weight: 7,0 kg/m²

Temp. range dry: -40÷80 °C

Temp. range wet: -40÷65 °C

Pin material: PBT white

LFB - Code 23

Low friction Acetal

Max w. load:

Straight 30000 N/m
Curve 2500 N

Weight: 7,0 kg/m²

Temp. range dry: -40÷80 °C

Temp. range wet: -40÷65 °C

Pin material: PBT white

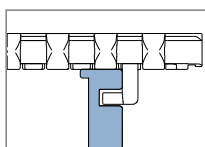

Use it with the **BluLub®** dedicated machined profiles.

Page 281

Example of application

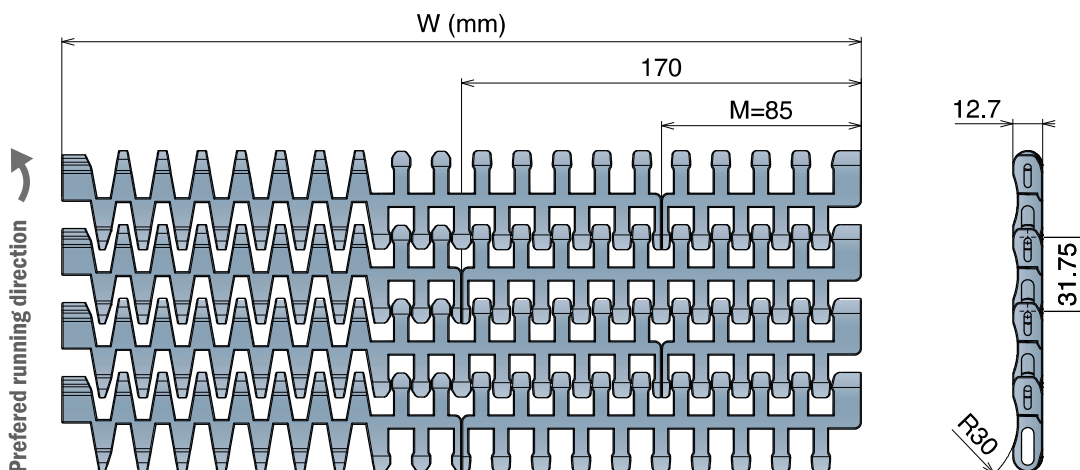

STANDARD

TAB

REVERSE TAB

TAB REVERSE TAB

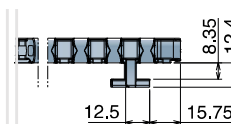
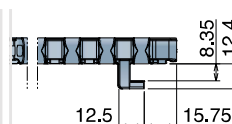
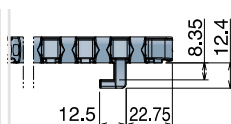

Series	Material	Width	Version	min radius
5423	*	0340	A	400
5423	*	0425	A	500
5423	*	0510	A	600
5423	*	0595	A	720
5423	*	0680	A	880
5423	*	0765	A	1040
5423	*	0850	A	1200

Series	Material	Width	Version	min radius
5423	*	0340	B	400
5423	*	0425	B	500
5423	*	0510	B	600
5423	*	0595	B	720
5423	*	0680	B	880
5423	*	0765	B	1040
5423	*	0850	B	1200

Series	Material	Width	Version	min radius
5423	*	0340	C	400
5423	*	0425	C	500
5423	*	0510	C	600
5423	*	0595	C	720
5423	*	0680	C	880
5423	*	0765	C	1040
5423	*	0850	C	1200

Series	Material	Width	Version	min radius
5423	*	0340	D	400
5423	*	0425	D	500
5423	*	0510	D	600
5423	*	0595	D	720
5423	*	0680	D	880
5423	*	0765	D	1040
5423	*	0850	D	1200

600 Heavy duty/Small radius

Tappeti modulari / Modular belts / Mattenketten

Belts wider than standard are available with 85 mm increments

Metric Size

600 Heavy duty/Small radius

Tappeto Modulare Curvilineo Serie 600, H=12,7 M=170
Side Flex Modular Belt Series 600, H=12,7 M=170 / Kurvengängige Mattenkette Serie 600, H=12,7 M=170

CODE STRUCTURE GUIDE (Example)

Backflex radius min.: 25 mm

5424	01	0425	E
Series	*Material	Width	Version

27.5%
OPEN SURFACE

31.75 mm
PITCH

		
pg. 373-374	pg. 180	pg. 771-781



*Material

LFA - Code 01

Low friction Acetal

Max w. load:

Straight 30000 N/m
Curve 3500 N

Weight: 7,5 kg/m²

Temp. range dry: -40+80 °C

Temp. range wet: -40+65 °C

Pin material: PBT white

LFB - Code 23

Low friction Acetal

Max w. load:

Straight 30000 N/m
Curve 3500 N

Weight: 7,5 kg/m²

Temp. range dry: -40+80 °C

Temp. range wet: -40+65 °C

Pin material: PBT white

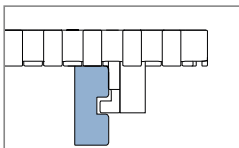

Use it with the **BluLub**® dedicated machined profiles.

Page 281

Example of application

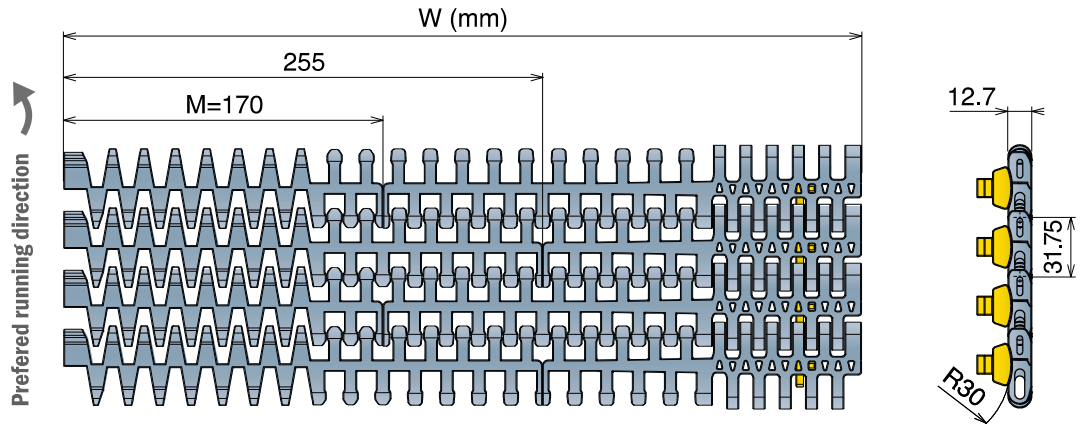

STANDARD

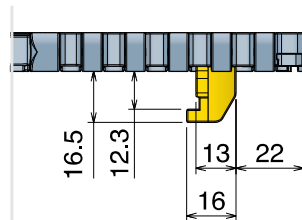

Series	Material	Width	Version	min radius
5424	*	0255	E	390
5424	*	0340	E	420
5424	*	0425	E	500
5424	*	0510	E	600
5424	*	0595	E	720
5424	*	0680	E	880
5424	*	0765	E	1040
5424	*	0850	E	1200

TAB DKM Material

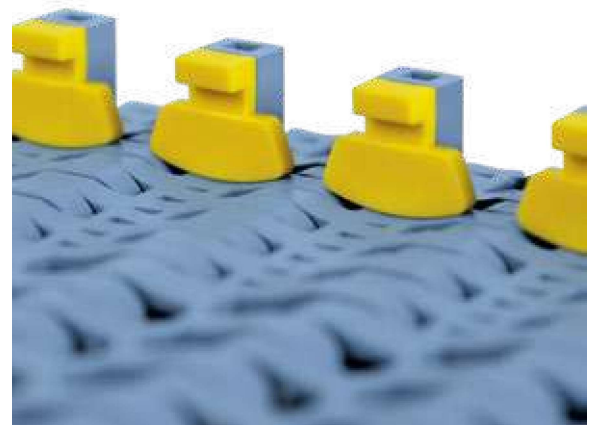

600 Heavy duty/Small radius with Bearings

Belts wider than standard are available with 85 mm increments

Tappeti modulari / Modular belts / Mattenketten

600 Heavy duty/Small radius with Bearings Tappeto Curvilineo Serie 600, H=12,7 M=170 Side Flex Modular Belt Series 600, H=12,7 M=170 / Kurvengängige Mattenkette Serie 600, H=12,7 M=170

CODE STRUCTURE GUIDE (Example)

Backflex radius min.: 25 mm

5424	01	0425	F
Series	*Material	Width	Version

27.5%
OPEN SURFACE

31.75 mm
PITCH

		
pg. 373-374	pg. 181	pg. 771>781



Metric Size

*Material

LFA - Code 01

Low friction Acetal

Max w. load:

Straight 30000 N/m
Curve 3500 N

Weight: 8,5 kg/m²

Temp. range dry: -40÷80 °C

Temp. range wet: -40÷65 °C

Pin material: PBT white

LFB - Code 23

Low friction Acetal

Max w. load:

Straight 30000 N/m
Curve 3500 N

Weight: 8,5 kg/m²

Temp. range dry: -40÷80 °C

Temp. range wet: -40÷65 °C

Pin material: PBT white

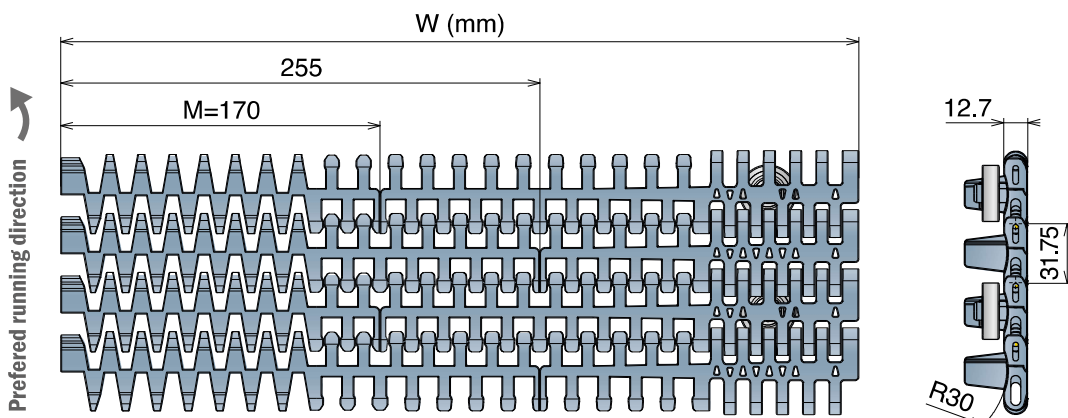
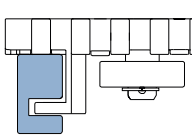
Use it with the **BluLub®** dedicated machined profiles.
Page 282
Example of application

STANDARD

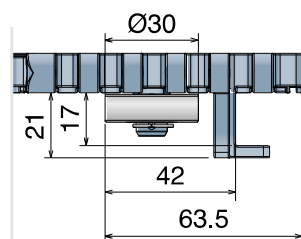

Series	Material	Width	Version	min radius
5424	*	0255	F	390
5424	*	0340	F	420
5424	*	0425	F	500
5424	*	0510	F	600
5424	*	0595	F	720
5424	*	0680	F	880
5424	*	0765	F	1040
5424	*	0850	F	1200

Bearing Zoom



600 with pusher

Tappeti modulari / Modular belts / Mattenketten

Metric Size

600 with pusher

Tappeto Modulare Curvilineo Serie 600, H=12,7 M=85
Side Flex Modular Belt Series 600, H=12,7 M=85 / Kurvengängige Mattenkette Serie 600, H=12,7 M=85



31.75 mm
PITCH

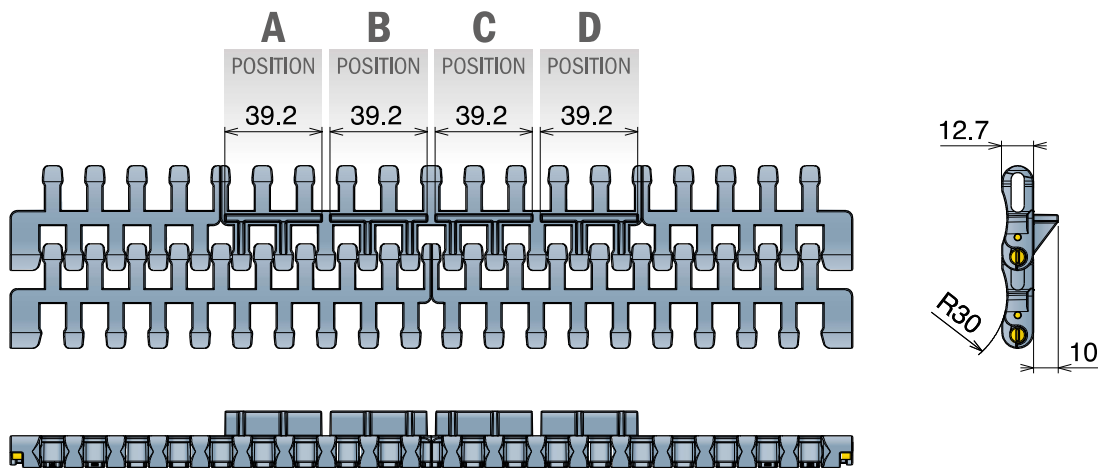

The pusher is applicable only for the center module, and there are available up to a maximum of 4 positions (**A-B-C-D**) or with different types of combinations (example **A-B-D** / **A-C** / **B-C-D**).

Consult our engineering department for details.