



# ZER<sup>520</sup> CONTACT

CURVE CONVEYOR

**Movex**<sup>®</sup>  
[www.movexii.com](http://www.movexii.com)

# Made in ITALY PERFORMING everywhere.



Company Headquarters  
Castelli calepio (BG) - ITALY

Movex® is a dynamic company driven by the ambition to design and manufacture conveying and material handling technology of the highest quality. We combine superior technical performance and design to provide customers with innovative solutions and impeccable service.

At our Italian headquarters, we design and manufacture standard and customized products and solutions to meet customers' needs in a dynamic and proactive environment.

Movex® follows every single customer from the project to installation, guaranteeing full support. With more than 30 technical sales representatives worldwide, we offer global support directly on-site, via video conference or by phone. Thanks to worldwide warehousing, we are able to provide short lead times and, in the event of the need for faster delivery times, our Priority Service, offering delivery in 1/2 working days, is always available.

As a leader in beverage and logistics conveyor components, Movex® stands as a robust entity in the industry with over 12 years of dynamic presence, ensuring quality products and impeccable service.



## MISSION

To forge our values through the development of ideas and high standards, and to professionally support our partners with flexibility and efficiency.



## VISION

To achieving strong market leadership, while constantly remaining up to date. To plan our future while remaining faithful to our history and values.

# Find out our complete range of solutions.

## Website

Consult our website and discover all our products.

[www.movexii.com](http://www.movexii.com)

## Product Catalog

Download the interactive PDF featuring all our products, from our website.

**Available on all devices.**

## Contact us

Ask to your sales representative, and required the hard copy of our catalogs.

[info@movexii.com](mailto:info@movexii.com)



**MOVEX, EXPERIENCE THE DIFFERENCE.**



## Priority service

**Even faster and responsive,  
when you need it.**

Products in stock are available to ship within 24 Hours of the receipt of order.

**>10.000** ARTICLES NUMBER  
READY TO DELIVERY

Priority service is optional,  
available on request

**Request a free quotation!**

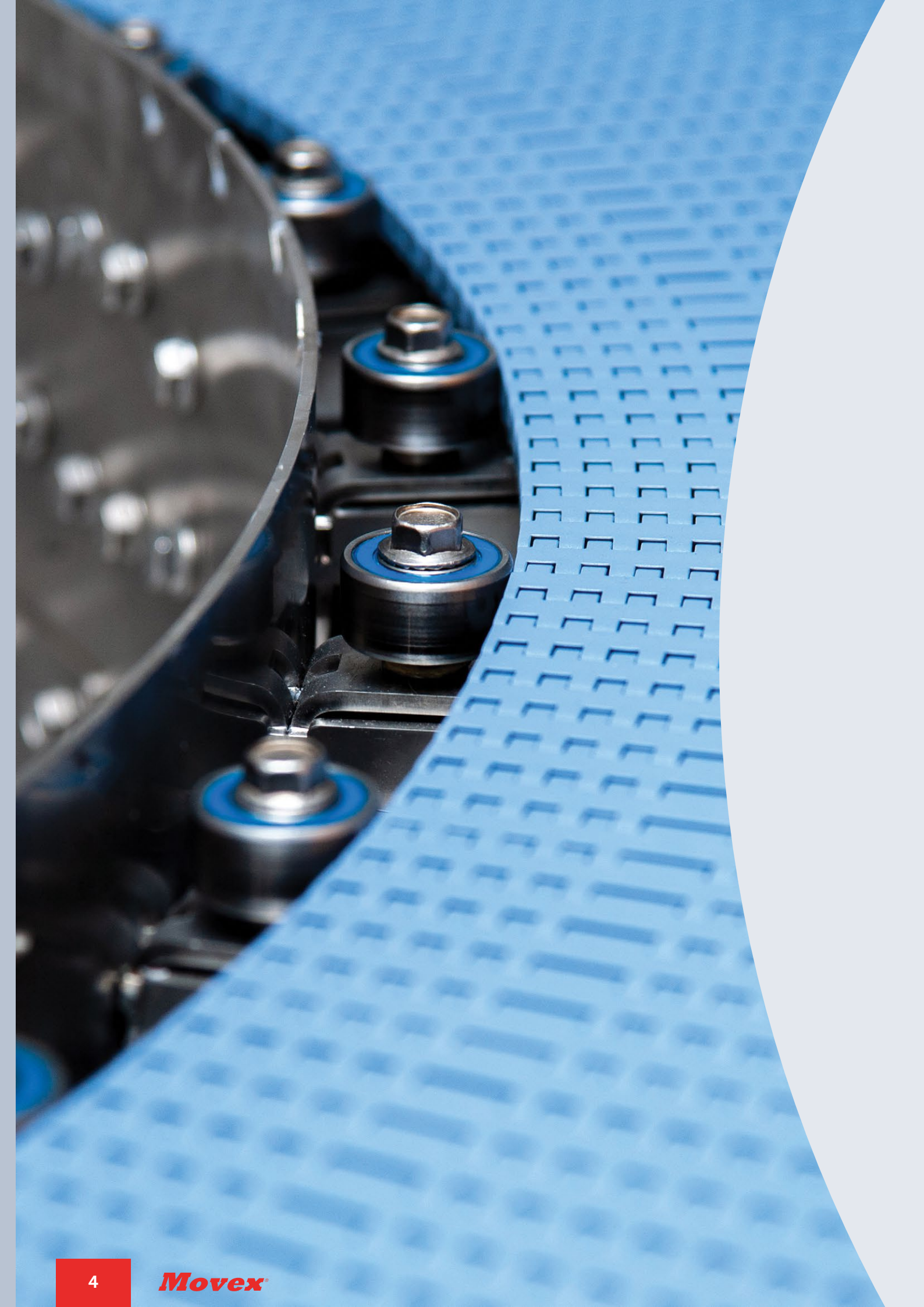

# ZERO<sup>520</sup>CONTACT

## CURVE CONVEYOR

The **Zero Contact™** Curve is a curve conveyor with a robust plastic belt with small pitches which is specifically designed to easily connect with straight conveyors. Short transfers and small inner radius contribute to compact design and integration in line layout.

The **Zero Contact™** Curve is available in different widths with a closed-top surface capable of handling a variety of package sizes, types and configurations including delicate products (e.g. applications exiting a shrink wrapper).

Find out the best solution for your application from our range of **Zero Contact™**, **Zero Contact™ PRO**, **Zero Contact™ S**, **Zero Contact™ Flat Edge** and **Zero Contact™ Hygienic**.



### Design

Innovative, robust and low noise construction conveyor



### Product care

Improved product handling, holding original orientation and safe product transfer



### Implementation

Easy implementation in existing layout and easy replacement in existing conveyor lines



### Radius and Pitch

Constant inner radius and small pitch



### Safe design

Closed-Top design and improved safety

# Zero Contact™

## Conveyor solution comparison



**Zero Contact™** curve has many advantages in comparison with the main traditional systems.

It's the perfect combination for reliability and efficiency, able to minimize maintenance costs and downtimes.

### Zero Contact benefits

- Higher loads
- Higher speeds
- Easier and quicker maintenance
- Lower cost for curve renewal
- Power drive evenly distributed
- Less downtime

### Zero Contact benefits

- Safer design – finger protection
- Complete closed sliding surface
- Full product support
- Simpler installation
- Easier and quicker maintenance
- Suitable for handling instable products

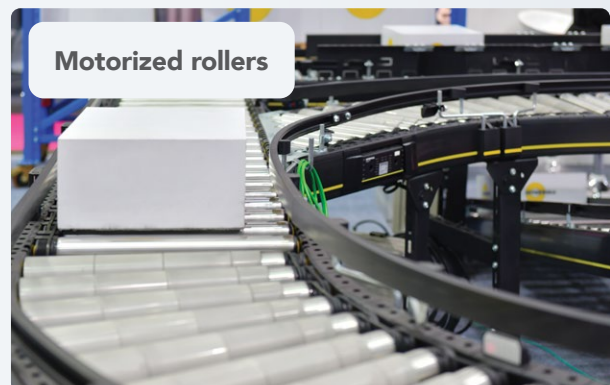

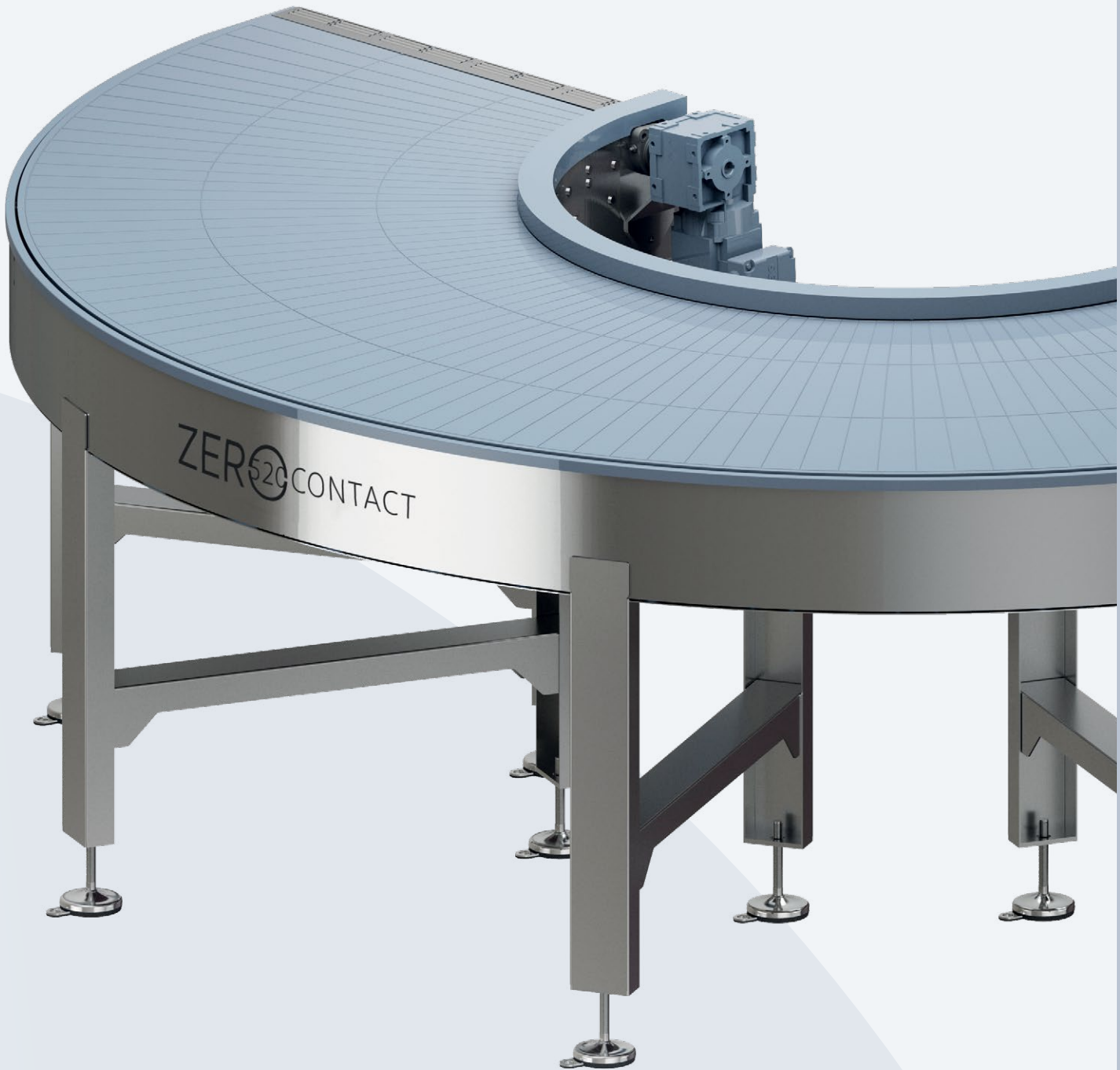

ZERO CONTACT

# ZER<sup>520</sup>CONTACT

## PRODUCT SELECTION GUIDELINE TOOL

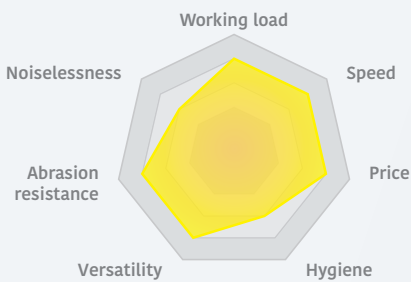
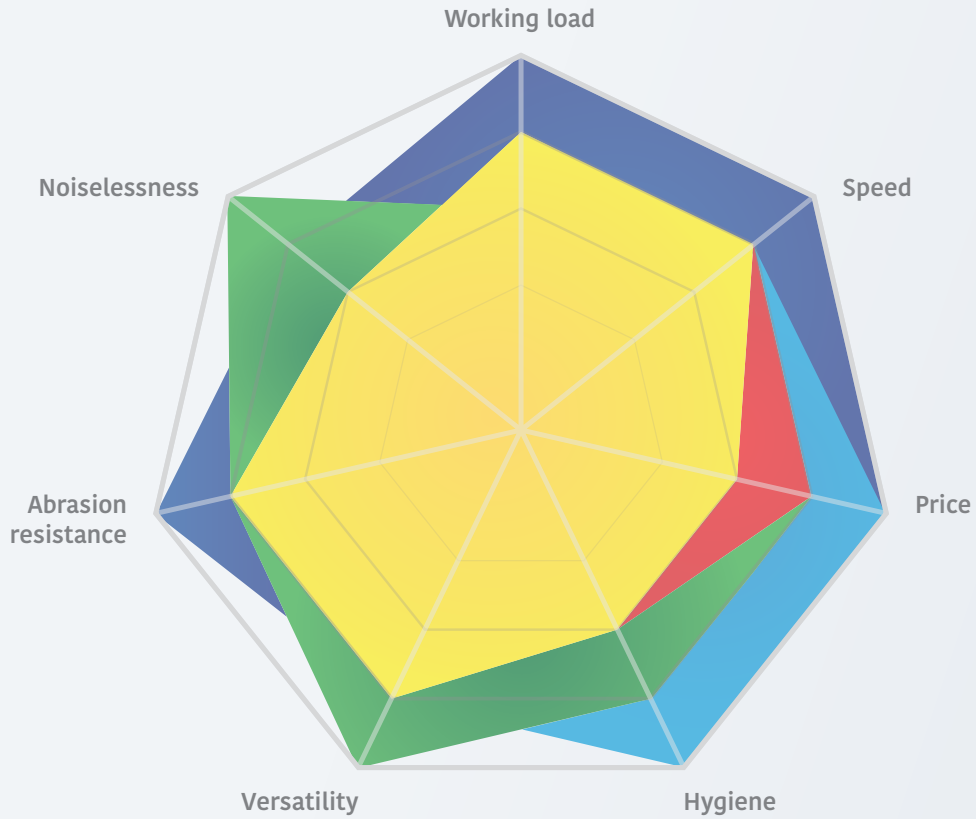

ZER<sup>520</sup>CONTACT  
CURVE CONVEYOR

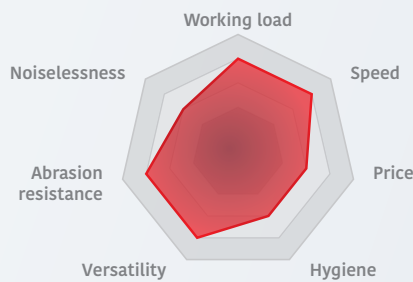

ZER<sup>520</sup>CONTACT S  
CURVE CONVEYOR

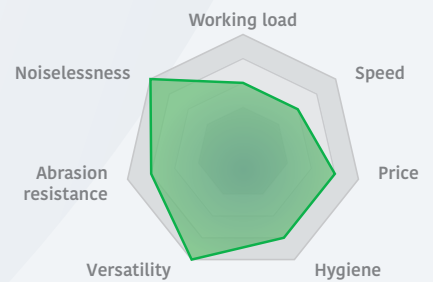

ZER<sup>EDGE</sup>CONTACT  
CURVE CONVEYOR

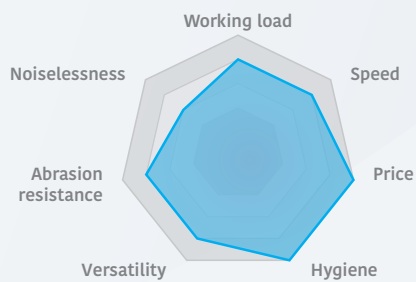

ZER<sup>520</sup>CONTACT #  
CURVE CONVEYOR

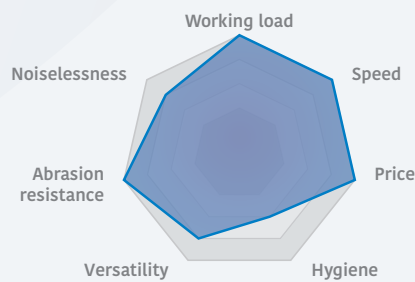

ZER<sup>PRO</sup>CONTACT  
CURVE CONVEYOR



<b>Zero Contact™</b> Curve Conveyor .....	<b>10-11</b>
<b>Zero Contact™ S</b> Curve Conveyor .....	<b>12-13</b>
<b>Zero Contact™ Flat Edge</b> Curve Conveyor .....	<b>14-15</b>
<b>Zero Contact™ Hygienic</b> Curve Conveyor .....	<b>16-17</b>
<b>Zero Contact™ PRO</b> Curve Conveyor .....	<b>18-19</b>
<b>Zero Contact™ PRO TWO TRACKS</b> Curve Conveyor .....	<b>20-21</b>
<b>Zero ATP</b> Active Transfer Plate .....	<b>22-23</b>
<b>Zero ATP Pro</b> Active Transfer Plate .....	<b>24</b>
Floor Supports .....	<b>25</b>
Gearmotors .....	<b>26</b>
<b>Zero Contact™</b> Side Flex Modular Belt .....	<b>28-29</b>
<b>Zero Contact™ PRO</b> Side Flex Modular Belt .....	<b>30-32</b>
Drive Sprockets .....	<b>33</b>
Main Dimensions .....	<b>34-35</b>
Related Items .....	<b>36-46</b>
Request for Quotation .....	<b>47-51</b>
General & Supply details .....	<b>52</b>

# ZERO CONTACT

## CURVE CONVEYOR

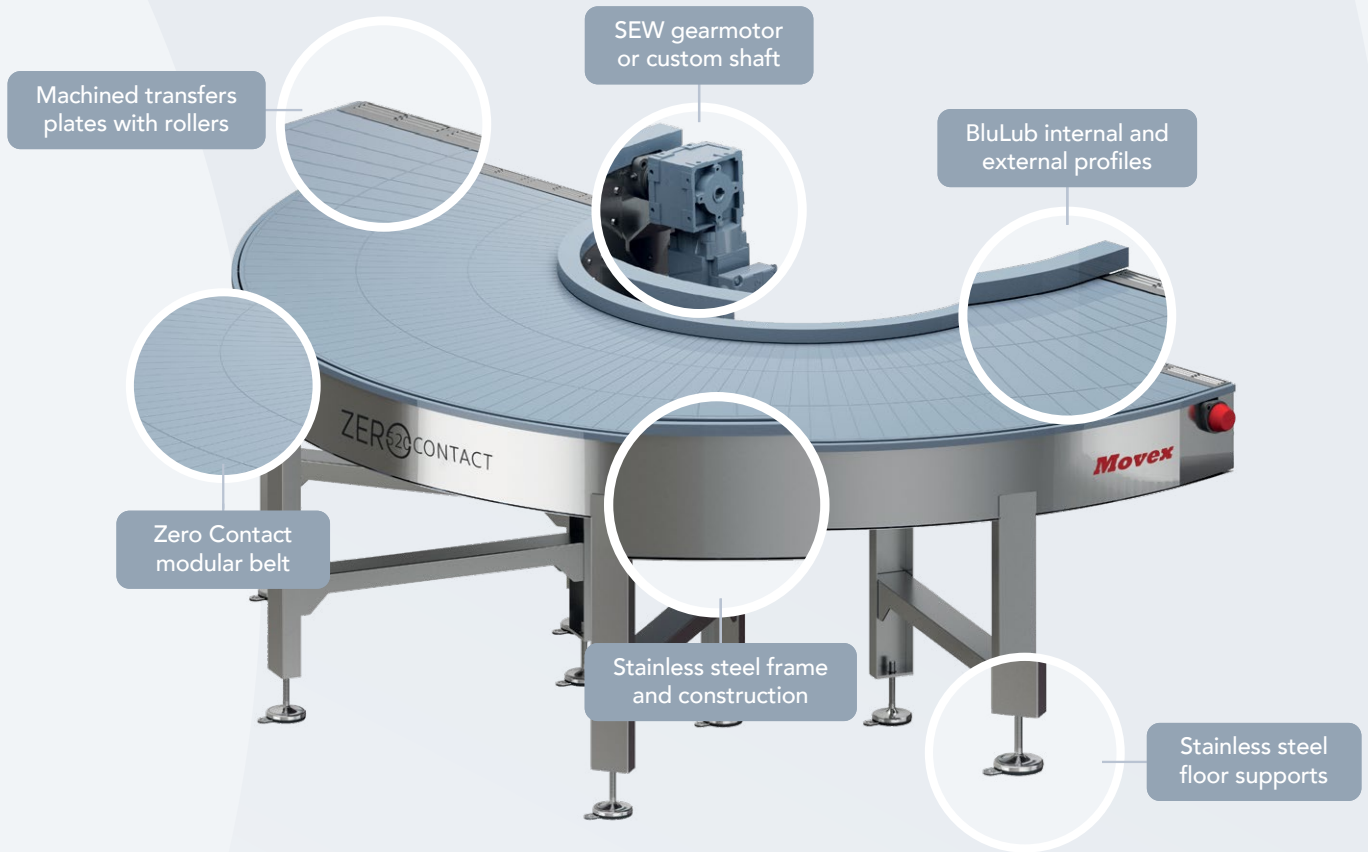

### Product use

The **Zero Contact™** curve conveyor is available in different widths with a closed-top surface capable of handling a variety of package sizes, types and configurations including delicate products and applications found on shrink wrappers.

**Zero Contact™** is designed to be used for the transport of various sized parts, is suitable for food and beverage industry thanks to the FDA approval, and helps reducing energy consumption and improving the line efficiency. It can be easily connected to existing layout.



**INNER RADIUS** 600mm ÷ 2000mm (23.6" ÷ 78.7")

**BELT WIDTH** 200mm ÷ 1600mm (7.9" ÷ 63")

**MATERIAL OF MODULES** Acetal (POM)

**COLOR OF MODULES** Pigeon Blue (RAL 5014)

**PINS** PBT White

**PIN LOCK** Clips

**FRAME** Stainless steel

**TEMPERATURE RANGE**

Dry: -40°C ÷ 80°C Wet: -40°C ÷ 65°C

(Dry: -40°F ÷ 176°F Wet: -40°F ÷ 149°F)

**MAX. WORKING LOAD**

13.500 N/m belt width (924 lb/ft belt width)

**CURVE ANGLE** 15° ÷ 360°

**OPEN AREA** 0%

# CURVES RANGE

Angle 90°

Left Version **CS**

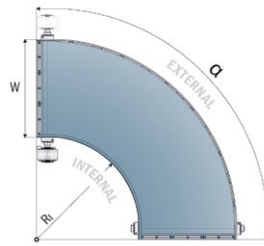

**CD** Right Version

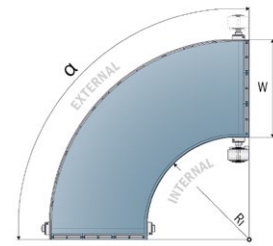

Width	Version	Rmin. 600mm (23.6")	Rmin. 800mm (31.5")	Rmin. 1000mm (39.4")	Rmin. 1200mm (47.2")	Rmin. 1400mm (55.1")	Rmin. 1600mm (63")	Rmin. 1800mm (70.8")	Rmin. 2000mm (78.7")
200mm (7,9")	RIGHT	W02R06G090-CD	W02R08G090-CD	W02R10G090-CD	W02R12G090-CD	W02R14G090-CD	W02R16G090-CD	W02R18G090-CD	W02R20G090-CD
	LEFT	W02R06G090-CS	W02R08G090-CS	W02R10G090-CS	W02R12G090-CS	W02R14G090-CS	W02R16G090-CS	W02R18G090-CS	W02R20G090-CS
400mm (15,7")	RIGHT	W04R06G090-CD	W04R08G090-CD	W04R10G090-CD	W04R12G090-CD	W04R14G090-CD	W04R16G090-CD	W04R18G090-CD	-
	LEFT	W04R06G090-CS	W04R08G090-CS	W04R10G090-CS	W04R12G090-CS	W04R14G090-CS	W04R16G090-CS	W04R18G090-CS	-
600mm (23,6")	RIGHT	W06R06G090-CD	W06R08G090-CD	W06R10G090-CD	W06R12G090-CD	W06R14G090-CD	W06R16G090-CD	-	-
	LEFT	W06R06G090-CS	W06R08G090-CS	W06R10G090-CS	W06R12G090-CS	W06R14G090-CS	W06R16G090-CS	-	-
800mm (31,5")	RIGHT	W08R06G090-CD	W08R08G090-CD	W08R10G090-CD	W08R12G090-CD	W08R14G090-CD	-	-	-
	LEFT	W08R06G090-CS	W08R08G090-CS	W08R10G090-CS	W08R12G090-CS	W08R14G090-CS	-	-	-
1000mm (39,4")	RIGHT	W10R06G090-CD	W10R08G090-CD	W10R10G090-CD	W10R12G090-CD	-	-	-	-
	LEFT	W10R06G090-CS	W10R08G090-CS	W10R10G090-CS	W10R12G090-CS	-	-	-	-
1200mm (47,2")	RIGHT	W12R06G090-CD	W12R08G090-CD	W12R10G090-CD	-	-	-	-	-
	LEFT	W12R06G090-CS	W12R08G090-CS	W12R10G090-CS	-	-	-	-	-
1400mm (55,1")	RIGHT	W14R06G090-CD	W14R08G090-CD	-	-	-	-	-	-
	LEFT	W14R06G090-CS	W14R08G090-CS	-	-	-	-	-	-
1600mm (63")	RIGHT	W16R06G090-CD	-	-	-	-	-	-	-
	LEFT	W16R06G090-CS	-	-	-	-	-	-	-

These codes mean complete curve, except floor supports and gearmotor, if you need to include them please see page 25-26.

# CURVES RANGE

Angle 180°

Left Version **CS**

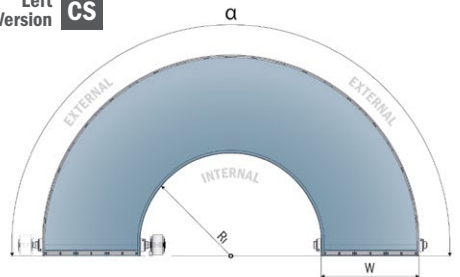

**CD** Right Version

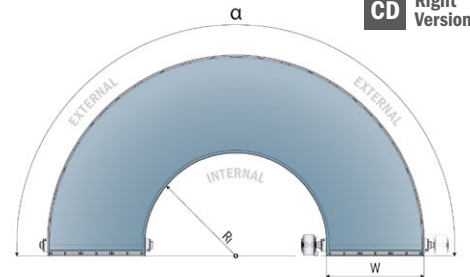

Width	Version	Rmin. 600mm (23.6")	Rmin. 800mm (31.5")	Rmin. 1000mm (39.4")	Rmin. 1200mm (47.2")	Rmin. 1400mm (55.1")	Rmin. 1600mm (63")	Rmin. 1800mm (70.8")	Rmin. 2000mm (78.7")
200mm (7,9")	RIGHT	W02R06G180-CD	W02R08G180-CD	W02R10G180-CD	W02R12G180-CD	W02R14G180-CD	W02R16G180-CD	W02R18G180-CD	W02R20G180-CD
	LEFT	W02R06G180-CS	W02R08G180-CS	W02R10G180-CS	W02R12G180-CS	W02R14G180-CS	W02R16G180-CS	W02R18G180-CS	W02R20G180-CS
400mm (15,7")	RIGHT	W04R06G180-CD	W04R08G180-CD	W04R10G180-CD	W04R12G180-CD	W04R14G180-CD	W04R16G180-CD	W04R18G180-CD	-
	LEFT	W04R06G180-CS	W04R08G180-CS	W04R10G180-CS	W04R12G180-CS	W04R14G180-CS	W04R16G180-CS	W04R18G180-CS	-
600mm (23,6")	RIGHT	W06R06G180-CD	W06R08G180-CD	W06R10G180-CD	W06R12G180-CD	W06R14G180-CD	W06R16G180-CD	-	-
	LEFT	W06R06G180-CS	W06R08G180-CS	W06R10G180-CS	W06R12G180-CS	W06R14G180-CS	W06R16G180-CS	-	-
800mm (31,5")	RIGHT	W08R06G180-CD	W08R08G180-CD	W08R10G180-CD	W08R12G180-CD	W08R14G180-CD	-	-	-
	LEFT	W08R06G180-CS	W08R08G180-CS	W08R10G180-CS	W08R12G180-CS	W08R14G180-CS	-	-	-
1000mm (39,4")	RIGHT	W10R06G180-CD	W10R08G180-CD	W10R10G180-CD	W10R12G180-CD	-	-	-	-
	LEFT	W10R06G180-CS	W10R08G180-CS	W10R10G180-CS	W10R12G180-CS	-	-	-	-
1200mm (47,2")	RIGHT	W12R06G180-CD	W12R08G180-CD	W12R10G180-CD	-	-	-	-	-
	LEFT	W12R06G180-CS	W12R08G180-CS	W12R10G180-CS	-	-	-	-	-
1400mm (55,1")	RIGHT	W14R06G180-CD	W14R08G180-CD	-	-	-	-	-	-
	LEFT	W14R06G180-CS	W14R08G180-CS	-	-	-	-	-	-
1600mm (63")	RIGHT	W16R06G180-CD	-	-	-	-	-	-	-
	LEFT	W16R06G180-CS	-	-	-	-	-	-	-

These codes mean complete curve, except floor supports and gearmotor, if you need to include them please see page 25-26.

# ZER<sup>520</sup>CONTACT<sup>S</sup>

## CURVE CONVEYOR

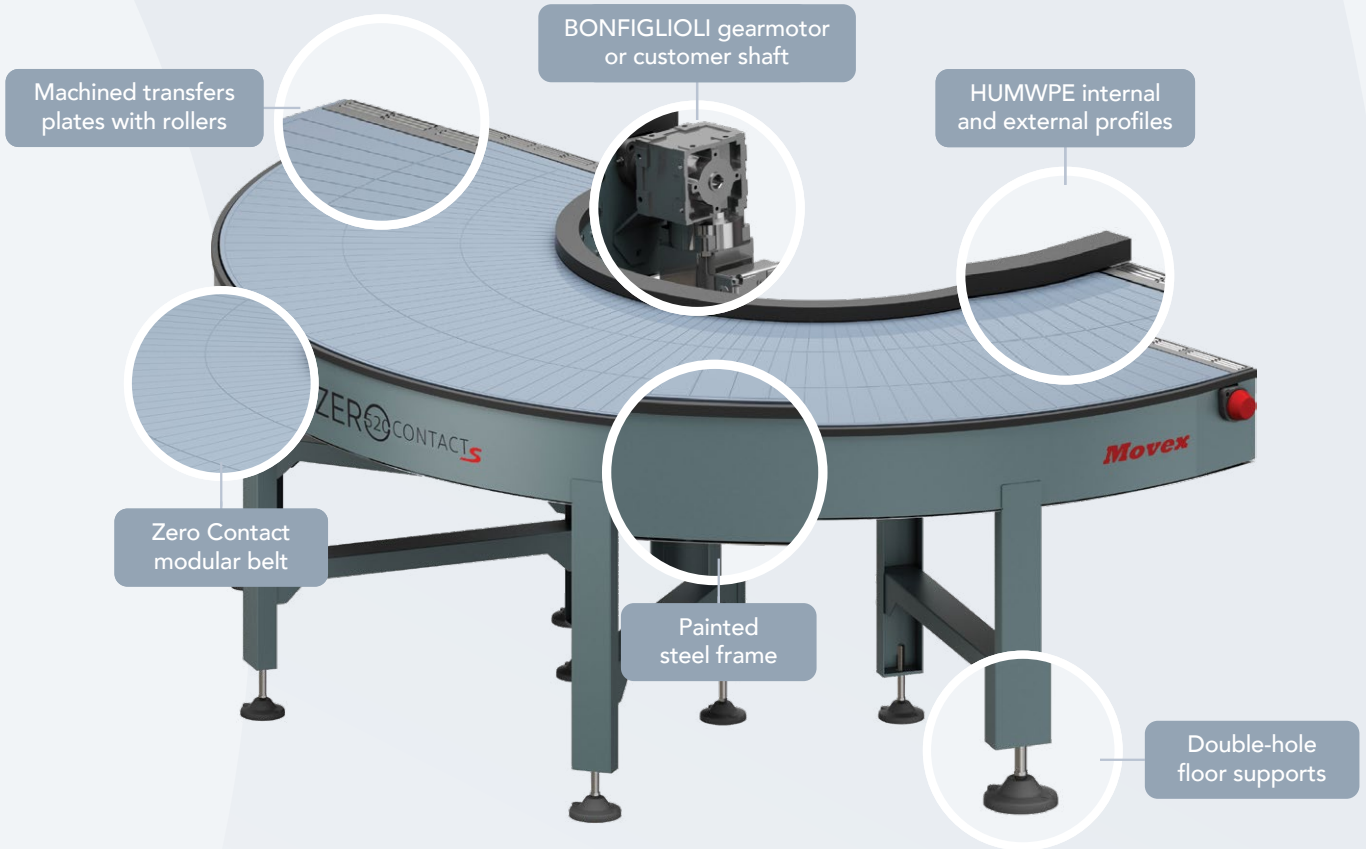

### Product use

**Zero Contact™ S** is ideal for logistic / handling and distribution centers as well as can also be adopted for all types of product transportation, like wood or ceramic applications, dry conditions. Painted steel frames can be customized with every type of color.

The **Zero Contact™ S** can be quickly installed into existing layout and fixed to the floor thanks to the leveling feet with double-floor fixation.



**INNER RADIUS** 600mm ÷ 2000mm (23.6" ÷ 78.7")

**BELT WIDTH** 200mm ÷ 1600mm (7.9" ÷ 63")

**MATERIAL OF MODULES** Acetal (POM)

**COLOR OF MODULES** Pigeon Blue (RAL 5014)

**PINS PBT** White

**PIN LOCK** Clips

**FRAME** Painted steel RAL 7031 or custom

#### TEMPERATURE RANGE

Dry: -40°C ÷ 80°C Wet: n.a.

(Dry: -40°F ÷ 176°F Wet: n.a.)

#### MAX. WORKING LOAD

13.500 N/m belt width (924 lb/ft belt width)

**CURVE ANGLE** 15° ÷ 360°

**OPEN AREA** 0%

# CURVES RANGE

## Angle 90°

Left Version **CSS**

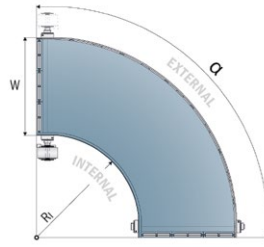

**CDS** Right Version

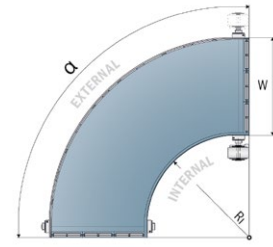

Width	Version	Rmin. 600mm (23.6")	Rmin. 800mm (31.5")	Rmin. 1000mm (39.4")	Rmin. 1200mm (47.2")	Rmin. 1400mm (55.1")	Rmin. 1600mm (63")	Rmin. 1800mm (70.8")	Rmin. 2000mm (78.7")
200mm (7,9")	RIGHT	W02R06G090-CDS	W02R08G090-CDS	W02R10G090-CDS	W02R12G090-CDS	W02R14G090-CDS	W02R16G090-CDS	W02R18G090-CDS	W02R20G090-CDS
	LEFT	W02R06G090-CSS	W02R08G090-CSS	W02R10G090-CSS	W02R12G090-CSS	W02R14G090-CSS	W02R16G090-CSS	W02R18G090-CSS	W02R20G090-CSS
400mm (15,7")	RIGHT	W04R06G090-CDS	W04R08G090-CDS	W04R10G090-CDS	W04R12G090-CDS	W04R14G090-CDS	W04R16G090-CDS	W04R18G090-CDS	-
	LEFT	W04R06G090-CSS	W04R08G090-CSS	W04R10G090-CSS	W04R12G090-CSS	W04R14G090-CSS	W04R16G090-CSS	W04R18G090-CSS	-
600mm (23,6")	RIGHT	W06R06G090-CDS	W06R08G090-CDS	W06R10G090-CDS	W06R12G090-CDS	W06R14G090-CDS	W06R16G090-CDS	-	-
	LEFT	W06R06G090-CSS	W06R08G090-CSS	W06R10G090-CSS	W06R12G090-CSS	W06R14G090-CSS	W06R16G090-CSS	-	-
800mm (31,5")	RIGHT	W08R06G090-CDS	W08R08G090-CDS	W08R10G090-CDS	W08R12G090-CDS	W08R14G090-CDS	-	-	-
	LEFT	W08R06G090-CSS	W08R08G090-CSS	W08R10G090-CSS	W08R12G090-CSS	W08R14G090-CSS	-	-	-
1000mm (39,4")	RIGHT	W10R06G090-CDS	W10R08G090-CDS	W10R10G090-CDS	W10R12G090-CDS	-	-	-	-
	LEFT	W10R06G090-CSS	W10R08G090-CSS	W10R10G090-CSS	W10R12G090-CSS	-	-	-	-
1200mm (47,2")	RIGHT	W12R06G090-CDS	W12R08G090-CDS	W12R10G090-CDS	-	-	-	-	-
	LEFT	W12R06G090-CSS	W12R08G090-CSS	W12R10G090-CSS	-	-	-	-	-
1400mm (55,1")	RIGHT	W14R06G090-CDS	W14R08G090-CDS	-	-	-	-	-	-
	LEFT	W14R06G090-CSS	W14R08G090-CSS	-	-	-	-	-	-
1600mm (63")	RIGHT	W16R06G090-CDS	-	-	-	-	-	-	-
	LEFT	W16R06G090-CSS	-	-	-	-	-	-	-

These codes mean complete curve, except floor supports and gearmotor, if you need to include them please see page 25-26.

# CURVES RANGE

## Angle 180°

Left Version **CSS**

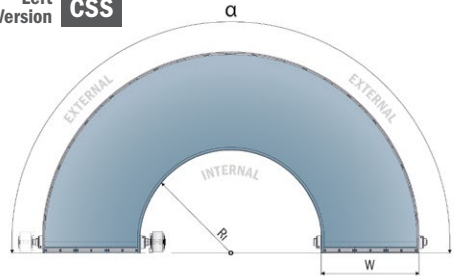

**CDS** Right Version

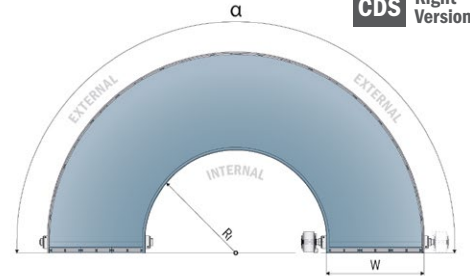

Width	Version	Rmin. 600mm (23.6")	Rmin. 800mm (31.5")	Rmin. 1000mm (39.4")	Rmin. 1200mm (47.2")	Rmin. 1400mm (55.1")	Rmin. 1600mm (63")	Rmin. 1800mm (70.8")	Rmin. 2000mm (78.7")
200mm (7,9")	RIGHT	W02R06G180-CDS	W02R08G180-CDS	W02R10G180-CDS	W02R12G180-CDS	W02R14G180-CDS	W02R16G180-CDS	W02R18G180-CDS	W02R20G180-CDS
	LEFT	W02R06G180-CSS	W02R08G180-CSS	W02R10G180-CSS	W02R12G180-CSS	W02R14G180-CSS	W02R16G180-CSS	W02R18G180-CSS	W02R20G180-CSS
400mm (15,7")	RIGHT	W04R06G180-CDS	W04R08G180-CDS	W04R10G180-CDS	W04R12G180-CDS	W04R14G180-CDS	W04R16G180-CDS	W04R18G180-CDS	-
	LEFT	W04R06G180-CSS	W04R08G180-CSS	W04R10G180-CSS	W04R12G180-CSS	W04R14G180-CSS	W04R16G180-CSS	W04R18G180-CSS	-
600mm (23,6")	RIGHT	W06R06G180-CDS	W06R08G180-CDS	W06R10G180-CDS	W06R12G180-CDS	W06R14G180-CDS	W06R16G180-CDS	-	-
	LEFT	W06R06G180-CSS	W06R08G180-CSS	W06R10G180-CSS	W06R12G180-CSS	W06R14G180-CSS	W06R16G180-CSS	-	-
80mm (31,5")	RIGHT	W08R06G180-CDS	W08R08G180-CDS	W08R10G180-CDS	W08R12G180-CDS	W08R14G180-CDS	-	-	-
	LEFT	W08R06G180-CSS	W08R08G180-CSS	W08R10G180-CSS	W08R12G180-CSS	W08R14G180-CSS	-	-	-
1000mm (39,4")	RIGHT	W10R06G180-CDS	W10R08G180-CDS	W10R10G180-CDS	W10R12G180-CDS	-	-	-	-
	LEFT	W10R06G180-CSS	W10R08G180-CSS	W10R10G180-CSS	W10R12G180-CSS	-	-	-	-
1200mm (47,2")	RIGHT	W12R06G180-CDS	W12R08G180-CDS	W12R10G180-CDS	-	-	-	-	-
	LEFT	W12R06G180-CSS	W12R08G180-CSS	W12R10G180-CSS	-	-	-	-	-
1400mm (55,1")	RIGHT	W14R06G180-CDS	W14R08G180-CDS	-	-	-	-	-	-
	LEFT	W14R06G180-CSS	W14R08G180-CSS	-	-	-	-	-	-
1600mm (63")	RIGHT	W16R06G180-CDS	-	-	-	-	-	-	-
	LEFT	W16R06G180-CSS	-	-	-	-	-	-	-

These codes mean complete curve, except floor supports and gearmotor, if you need to include them please see page 25-26.

# ZER CONTACT

## CURVE CONVEYOR

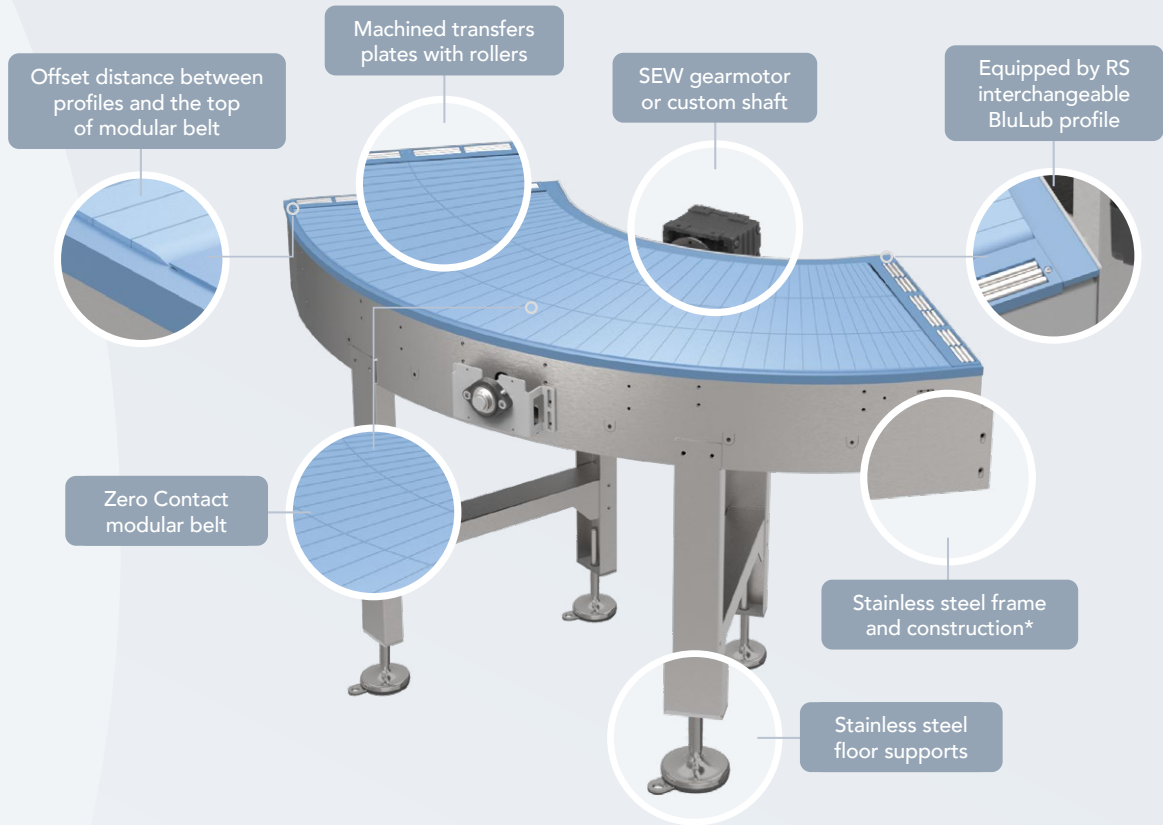

### Product use

**Zero Contact™ Flat Edge** is the advanced curve conveyor system designed for versatility and efficiency. With a reduced offset distance between profiles and the top of the modular belt, it handles wide packages with ease and accuracy. Its bidirectional design and central drive ensure quick direction changes, while its energy-efficient operation reduces costs and environmental impact. **Zero Contact™ Flat Edge** optimizes line efficiency and minimizes downtime, also for corrugated and wood industries.

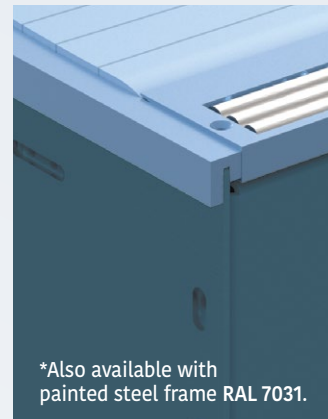

\*Also available with painted steel frame RAL 7031.

**INNER RADIUS** 600mm ÷ 2000mm (23.6" ÷ 78.7")

**BELT WIDTH** 200mm ÷ 1600mm (7.9" ÷ 63")

**MATERIAL OF MODULES** Acetal (POM)

**COLOR OF MODULES** Pigeon Blue (RAL 5014)

**PINS** PBT White

**PIN LOCK** Clips

**FRAME** Stainless steel\*

**TEMPERATURE RANGE**

Dry: -40°C ÷ 80°C Wet: -40°C ÷ 65°C

(Dry: -40°F ÷ 176°F Wet: -40°F ÷ 149°F)

**MAX. WORKING LOAD**

13.500 N/m belt width

**CURVE ANGLE** 90°/180° (different on request)

**OPEN AREA** 0%

# CURVES RANGE

## Angle 90°

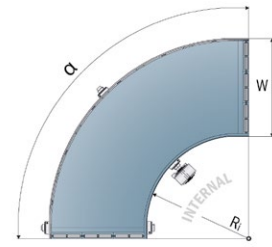

Width	Version	Rmin. 600mm (23.6")	Rmin. 800mm (31.5")	Rmin. 1000mm (39.4")	Rmin. 1200mm (47.2")	Rmin. 1400mm (55.1")	Rmin. 1600mm (63")	Rmin. 1800mm (70.8")	Rmin. 2000mm (78.7")
200mm (7,9")	BI-DIRECTIONAL	W02R06G090-CP	W02R08G090-CP	W02R10G090-CP	W02R12G090-CP	W02R14G090-CP	W02R16G090-CP	W02R18G090-CP	W02R20G090-CP
400mm (15,7")	BI-DIRECTIONAL	W04R06G090-CP	W04R08G090-CP	W04R10G090-CP	W04R12G090-CP	W04R14G090-CP	W04R16G090-CP	W04R18G090-CP	-
600mm (23,6")	BI-DIRECTIONAL	W06R06G090-CP	W06R08G090-CP	W06R10G090-CP	W06R12G090-CP	W06R14G090-CP	W06R16G090-CP	-	-
800mm (31,5")	BI-DIRECTIONAL	W08R06G090-CP	W08R08G090-CP	W08R10G090-CP	W08R12G090-CP	W08R14G090-CP	-	-	-
1000mm (39,4")	BI-DIRECTIONAL	W10R06G090-CP	W10R08G090-CP	W10R10G090-CP	W10R12G090-CP	-	-	-	-
1200mm (47,2")	BI-DIRECTIONAL	W12R06G090-CP	W12R08G090-CP	W12R10G090-CP	-	-	-	-	-
1400mm (55,1")	BI-DIRECTIONAL	W14R06G090-CP	W14R08G090-CP	-	-	-	-	-	These codes mean complete curve, except floor supports and gearmotor, if you need to include them please see page 25-26.
1600mm (63")	BI-DIRECTIONAL	W16R06G090-CP	-	-	-	-	-	-	

# CURVES RANGE

## Angle 180°

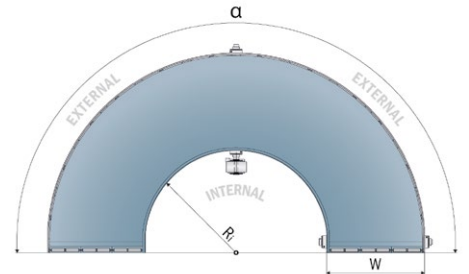

Width	Version	Rmin. 600mm (23.6")	Rmin. 800mm (31.5")	Rmin. 1000mm (39.4")	Rmin. 1200mm (47.2")	Rmin. 1400mm (55.1")	Rmin. 1600mm (63")	Rmin. 1800mm (70.8")	Rmin. 2000mm (78.7")
200mm (7,9")	BI-DIRECTIONAL	W02R06G180-CP	W02R08G180-CP	W02R10G180-CP	W02R12G180-CP	W02R14G180-CP	W02R16G180-CP	W02R18G180-CP	W02R20G180-CP
400mm (15,7")	BI-DIRECTIONAL	W04R06G180-CP	W04R08G180-CP	W04R10G180-CP	W04R12G180-CP	W04R14G180-CP	W04R16G180-CP	W04R18G180-CP	-
600mm (23,6")	BI-DIRECTIONAL	W06R06G180-CP	W06R08G180-CP	W06R10G180-CP	W06R12G180-CP	W06R14G180-CP	W06R16G180-CP	-	-
800mm (31,5")	BI-DIRECTIONAL	W08R06G180-CP	W08R08G180-CP	W08R10G180-CP	W08R12G180-CP	W08R14G180-CP	-	-	-
1000mm (39,4")	BI-DIRECTIONAL	W10R06G180-CP	W10R08G180-CP	W10R10G180-CP	W10R12G180-CP	-	-	-	-
1200mm (47,2")	BI-DIRECTIONAL	W12R06G180-CP	W12R08G180-CP	W12R10G180-CP	-	-	-	-	-
1400mm (55,1")	BI-DIRECTIONAL	W14R06G180-CP	W14R08G180-CP	-	-	-	-	-	These codes mean complete curve, except floor supports and gearmotor, if you need to include them please see page 25-26.
1600mm (63")	BI-DIRECTIONAL	W16R06G180-CP	-	-	-	-	-	-	

# ZER<sup>520</sup>CONTACT#

## CURVE CONVEYOR



### Product use

Specifically designed for industrial environments with critical hygienic level, **Zero Contact™ Hygienic** is the perfect solutions for dairy, food, chemical and pharmaceutical industries, subjected to daily washing cycles. **Zero Contact™ Hygienic** modular belt is approved for direct food contact by FDA. Any bulk food product can stay on the modular belt without contamination. With reference to the foodstuff categories detailed by Reg. (EU) No. 10/2011.



**INNER RADIUS** 600mm ÷ 2000mm (23.6" ÷ 78.7")  
**BELT WIDTH** 200mm ÷ 1600mm (7.9" ÷ 63")  
**MATERIAL OF MODULES** Acetal (POM)  
**COLOR OF MODULES** LFB (Blue)  
**PINS** PBT White  
**PIN LOCK** Clips  
**FRAME** Stainless steel

**TEMPERATURE RANGE**  
 Dry: -40°C ÷ 80°C Wet: -40°C ÷ 65°C  
 (Dry: -40°F ÷ 176°F Wet: -40°F ÷ 149°F)  
**MAX. WORKING LOAD**  
 13.500 N/m belt width (924 lb/ft belt width)  
**CURVE ANGLE** 90° ÷ 180° (different on request)  
**OPEN AREA** 0%



# CURVES RANGE

## Angle 90°

Left Version **CSH**

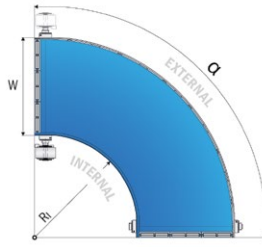

**CDH** Right Version

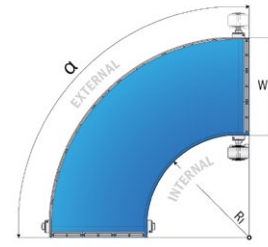

Width	Version	Rmin. 600mm (23.6")	Rmin. 800mm (31.5")	Rmin. 1000mm (39.4")	Rmin. 1200mm (47.2")	Rmin. 1400mm (55.1")	Rmin. 1600mm (63")	Rmin. 1800mm (70.8")	Rmin. 2000mm (78.7")
200mm (7,9")	RIGHT	W02R06G090-CDH	W02R08G090-CDH	W02R10G090-CDH	W02R12G090-CDH	W02R14G090-CDH	W02R16G090-CDH	W02R18G090-CDH	W02R20G090-CDH
	LEFT	W02R06G090-CSH	W02R08G090-CSH	W02R10G090-CSH	W02R12G090-CSH	W02R14G090-CSH	W02R16G090-CSH	W02R18G090-CSH	W02R20G090-CSH
400mm (15,7")	RIGHT	W04R06G090-CDH	W04R08G090-CDH	W04R10G090-CDH	W04R12G090-CDH	W04R14G090-CDH	W04R16G090-CDH	W04R18G090-CDH	-
	LEFT	W04R06G090-CSH	W04R08G090-CSH	W04R10G090-CSH	W04R12G090-CSH	W04R14G090-CSH	W04R16G090-CSH	W04R18G090-CSH	-
600mm (23,6")	RIGHT	W06R06G090-CDH	W06R08G090-CDH	W06R10G090-CDH	W06R12G090-CDH	W06R14G090-CDH	W06R16G090-CDH	-	-
	LEFT	W06R06G090-CSH	W06R08G090-CSH	W06R10G090-CSH	W06R12G090-CSH	W06R14G090-CSH	W06R16G090-CSH	-	-
800mm (31,5")	RIGHT	W08R06G090-CDH	W08R08G090-CDH	W08R10G090-CDH	W08R12G090-CDH	W08R14G090-CDH	-	-	-
	LEFT	W08R06G090-CSH	W08R08G090-CSH	W08R10G090-CSH	W08R12G090-CSH	W08R14G090-CSH	-	-	-
1000mm (39,4")	RIGHT	W10R06G090-CDH	W10R08G090-CDH	W10R10G090-CDH	W10R12G090-CDH	-	-	-	-
	LEFT	W10R06G090-CSH	W10R08G090-CSH	W10R10G090-CSH	W10R12G090-CSH	-	-	-	-
1200mm (47,2")	RIGHT	W12R06G090-CDH	W12R08G090-CDH	W12R10G090-CDH	-	-	-	-	-
	LEFT	W12R06G090-CSH	W12R08G090-CSH	W12R10G090-CSH	-	-	-	-	-
1400mm (55,1")	RIGHT	W14R06G090-CDH	W14R08G090-CDH	-	-	-	-	-	-
	LEFT	W14R06G090-CSH	W14R08G090-CSH	-	-	-	-	-	-
1600mm (63")	RIGHT	W16R06G090-CDH	-	-	-	-	-	-	-
	LEFT	W16R06G090-CSH	-	-	-	-	-	-	-

These codes mean complete curve, except floor supports and gearmotor, if you need to include them please see page 25-26.

# CURVES RANGE

## Angle 180°

Left Version **CSH**

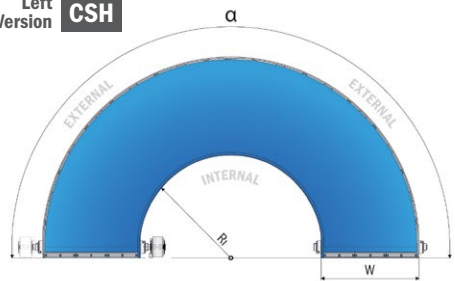

**CDH** Right Version

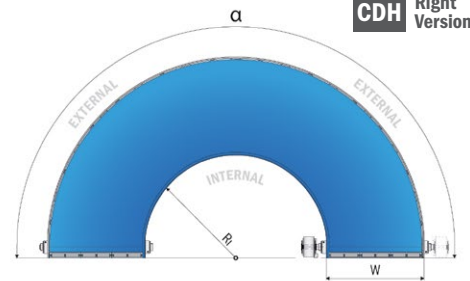

Width	Version	Rmin. 600mm (23.6")	Rmin. 800mm (31.5")	Rmin. 1000mm (39.4")	Rmin. 1200mm (47.2")	Rmin. 1400mm (55.1")	Rmin. 1600mm (63")	Rmin. 1800mm (70.8")	Rmin. 2000mm (78.7")
200mm (7,9")	RIGHT	W02R06G180-CDH	W02R08G180-CDH	W02R10G180-CDH	W02R12G180-CDH	W02R14G180-CDH	W02R16G180-CDH	W02R18G180-CDH	W02R20G180-CDH
	LEFT	W02R06G180-CSH	W02R08G180-CSH	W02R10G180-CSH	W02R12G180-CSH	W02R14G180-CSH	W02R16G180-CSH	W02R18G180-CSH	W02R20G180-CSH
400mm (15,7")	RIGHT	W04R06G180-CDH	W04R08G180-CDH	W04R10G180-CDH	W04R12G180-CDH	W04R14G180-CDH	W04R16G180-CDH	W04R18G180-CDH	-
	LEFT	W04R06G180-CSH	W04R08G180-CSH	W04R10G180-CSH	W04R12G180-CSH	W04R14G180-CSH	W04R16G180-CSH	W04R18G180-CSH	-
600mm (23,6")	RIGHT	W06R06G180-CDH	W06R08G180-CDH	W06R10G180-CDH	W06R12G180-CDH	W06R14G180-CDH	W06R16G180-CDH	-	-
	LEFT	W06R06G180-CSH	W06R08G180-CSH	W06R10G180-CSH	W06R12G180-CSH	W06R14G180-CSH	W06R16G180-CSH	-	-
80mm (31,5")	RIGHT	W08R06G180-CDH	W08R08G180-CDH	W08R10G180-CDH	W08R12G180-CDH	W08R14G180-CDH	-	-	-
	LEFT	W08R06G180-CSH	W08R08G180-CSH	W08R10G180-CSH	W08R12G180-CSH	W08R14G180-CSH	-	-	-
1000mm (39,4")	RIGHT	W10R06G180-CDH	W10R08G180-CDH	W10R10G180-CDH	W10R12G180-CDH	-	-	-	-
	LEFT	W10R06G180-CSH	W10R08G180-CSH	W10R10G180-CSH	W10R12G180-CSH	-	-	-	-
1200mm (47,2")	RIGHT	W12R06G180-CDH	W12R08G180-CDH	W12R10G180-CDH	-	-	-	-	-
	LEFT	W12R06G180-CSH	W12R08G180-CSH	W12R10G180-CSH	-	-	-	-	-
1400mm (55,1")	RIGHT	W14R06G180-CDH	W14R08G180-CDH	-	-	-	-	-	-
	LEFT	W14R06G180-CSH	W14R08G180-CSH	-	-	-	-	-	-
1600mm (63")	RIGHT	W16R06G180-CDH	-	-	-	-	-	-	-
	LEFT	W16R06G180-CSH	-	-	-	-	-	-	-

These codes mean complete curve, except floor supports and gearmotor, if you need to include them please see page 25-26.

# ZERO<sup>PRO</sup> CONTACT

## CURVE CONVEYOR

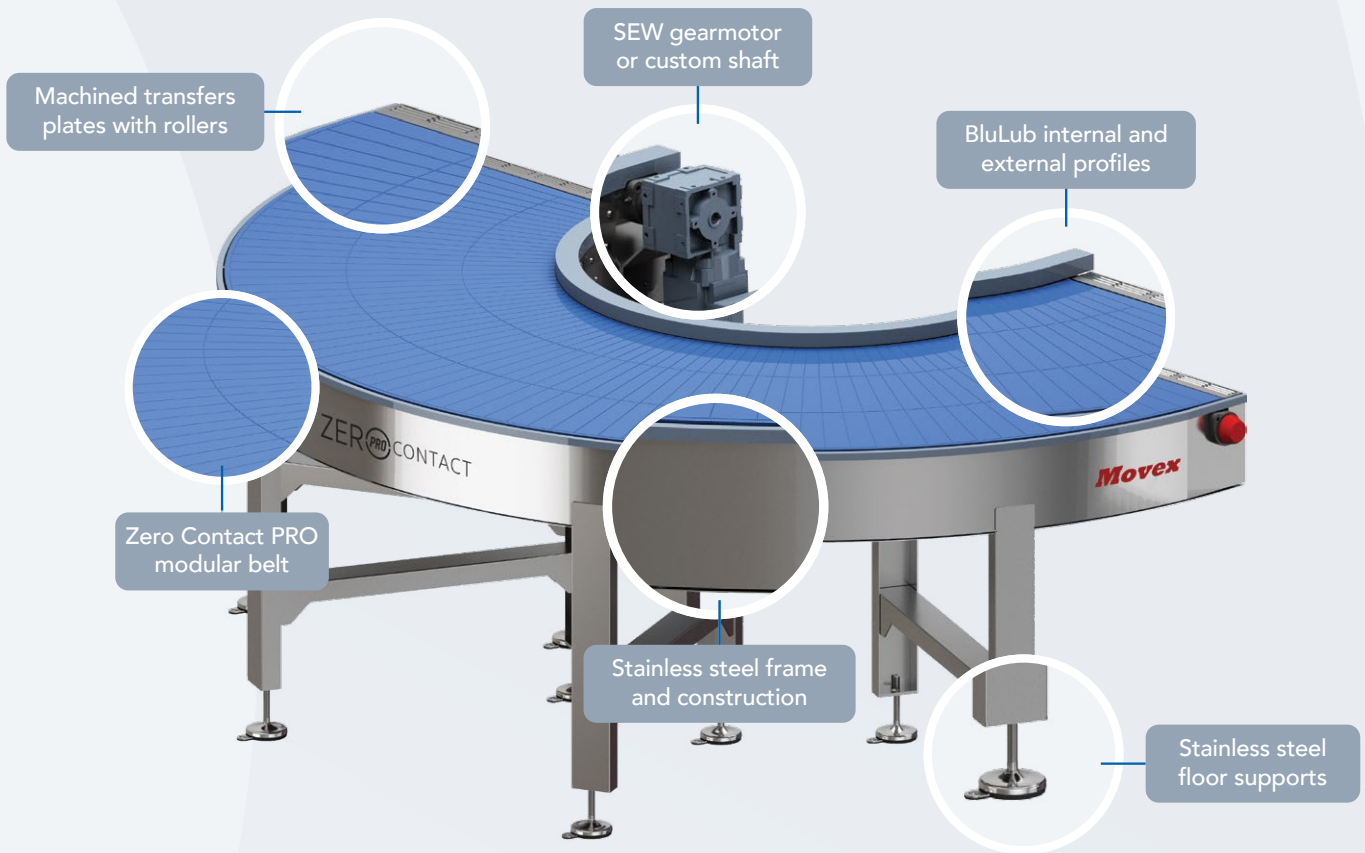

### Product use

The **Zero Contact™ PRO** is the right choice for heavy duty applications with high abrasive conditions, like sand, salt or sugar as well as production of tiles, bricks and cement production or applications where speeds and loads result very high.

**Zero Contact™ PRO** is designed with different dimensions and features, so to guarantee higher performance for hostile environments:



The belt in Polyamide glass fiber reinforced, more resistant to high wear conditions



The rods in stainless steel and fixed by using grub screws guarantee high loads

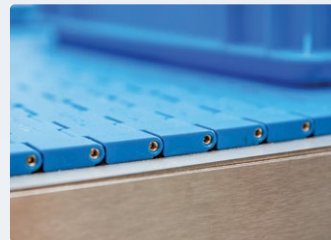
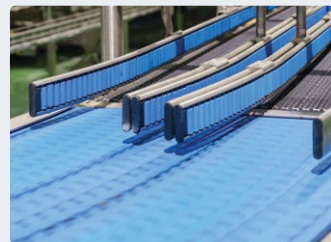

**INNER RADIUS** 586mm ÷ 1541mm (23.1" ÷ 60.7")

**BELT WIDTH** 249mm ÷ 1034mm (9.8" ÷ 40.7")

**MATERIAL OF MODULES**

Polyamide glass fiber reinforced (PA)

**COLOR OF MODULES**

Dark Pigeon Blue (RAL 5017)

**PINS** Stainless steel

**PIN LOCK** Stainless steel grub screws

**FRAME** Stainless steel

**TEMPERATURE RANGE**

Dry: -30°C ÷ 100°C Wet: n.a.

(Dry: -22°F ÷ 212°F Wet: n.a.)

**MAX. WORKING LOAD**

19.000 N/m belt width (1.300 lb/ft belt width)

**CURVE ANGLE** 15° ÷ 360°

**OPEN AREA** 0%

# CURVES RANGE

## Angle 90°

Left Version **CS**

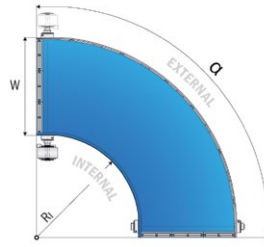

**CD** Right Version

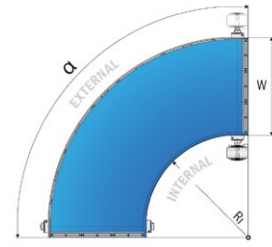

Width	Version	Rmin. 586mm (23.1")	Rmin. 756mm (29.8")	Rmin. 1011mm (39.8")	Rmin. 1031mm (40.6")	Rmin. 1116mm (43.9")	Rmin. 1201mm (47.3")	Rmin. 1286mm (50.6")	Rmin. 1456mm (57.3")	Rmin. 1541mm (60.7")
249mm (9.8")	RIGHT	-	-	-	W91R94G090-CD	-	-	W91R97G090-CD	-	-
	LEFT	-	-	-	W91R94G090-CS	-	-	W91R97G090-CS	-	-
269mm (10.6")	RIGHT	-	W92R92G090-CD	W92R93G090-CD	-	-	-	-	-	-
	LEFT	-	W92R92G090-CS	W92R93G090-CS	-	-	-	-	-	-
419mm (16.5")	RIGHT	-	-	-	W93R94G090-CD	-	W93R96G090-CD	-	W93R98G090-CD	-
	LEFT	-	-	-	W93R94G090-CS	-	W93R96G090-CS	-	W93R98G090-CS	-
439mm (17.3")	RIGHT	W94R91G090-CD	W94R92G090-CD	W94R93G090-CD	-	-	-	-	-	-
	LEFT	W94R91G090-CS	W94R92G090-CS	W94R93G090-CS	-	-	-	-	-	-
504mm (19.8")	RIGHT	-	-	-	-	W95R95G090-CD	-	W95R97G090-CD	-	W95R99G090-CD
	LEFT	-	-	-	-	W95R95G090-CS	-	W95R97G090-CS	-	W95R99G090-CS
524mm (20.6")	RIGHT	W96R91G090-CD	W96R92G090-CD	W96R93G090-CD	-	-	-	-	-	-
	LEFT	W96R91G090-CS	W96R92G090-CS	W96R93G090-CS	-	-	-	-	-	-
864mm (34")	RIGHT	W97R91G090-CD	W97R92G090-CD	W97R93G090-CD	-	-	-	-	-	-
	LEFT	W97R91G090-CS	W97R92G090-CS	W97R93G090-CS	-	-	-	-	-	-
1034mm (40.7")	RIGHT	W98R91G090-CD	W98R92G090-CD	W98R93G090-CD	-	-	-	-	-	-
	LEFT	W98R91G090-CS	W98R92G090-CS	W98R93G090-CS	-	-	-	-	-	-

These codes mean complete curve, except floor supports and gearmotor, if you need to include them please see page 25-26.

# CURVES RANGE

## Angle 180°

Left Version **CS**

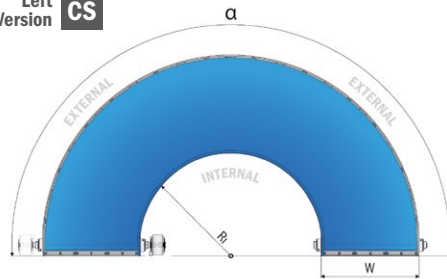

**CD** Right Version

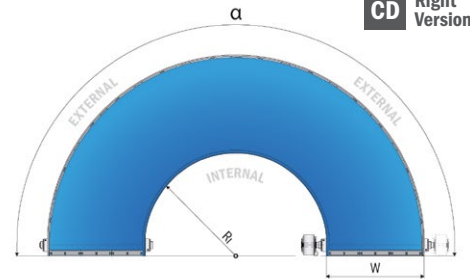

Width	Version	Rmin. 586mm (23.1")	Rmin. 756mm (29.8")	Rmin. 1011mm (39.8")	Rmin. 1031mm (40.6")	Rmin. 1116mm (43.9")	Rmin. 1201mm (47.3")	Rmin. 1286mm (50.6")	Rmin. 1456mm (57.3")	Rmin. 1541mm (60.7")
249mm (9.8")	RIGHT	-	-	-	W91R94G180-CD	-	-	W91R97G180-CD	-	-
	LEFT	-	-	-	W91R94G180-CS	-	-	W91R97G180-CS	-	-
269mm (10.6")	RIGHT	-	W92R92G180-CD	W92R93G180-CD	-	-	-	-	-	-
	LEFT	-	W92R92G180-CS	W92R93G180-CS	-	-	-	-	-	-
419mm (16.5")	RIGHT	-	-	-	W93R94G180-CD	-	W93R96G180-CD	-	W93R98G180-CD	-
	LEFT	-	-	-	W93R94G180-CS	-	W93R96G180-CS	-	W93R98G180-CS	-
439mm (17.3")	RIGHT	W94R91G180-CD	W94R92G180-CD	W94R93G180-CD	-	-	-	-	-	-
	LEFT	W94R91G180-CS	W94R92G180-CS	W94R93G180-CS	-	-	-	-	-	-
504mm (19.8")	RIGHT	-	-	-	-	W95R95G180-CD	-	W95R97G180-CD	-	W95R99G180-CD
	LEFT	-	-	-	-	W95R95G180-CS	-	W95R97G180-CS	-	W95R99G180-CS
524mm (20.6")	RIGHT	W96R91G180-CD	W96R92G180-CD	W96R93G180-CD	-	-	-	-	-	-
	LEFT	W96R91G180-CS	W96R92G180-CS	W96R93G180-CS	-	-	-	-	-	-
864mm (34")	RIGHT	W97R91G180-CD	W97R92G180-CD	W97R93G180-CD	-	-	-	-	-	-
	LEFT	W97R91G180-CS	W97R92G180-CS	W97R93G180-CS	-	-	-	-	-	-
1034mm (40.7")	RIGHT	W98R91G180-CD	W98R92G180-CD	W98R93G180-CD	-	-	-	-	-	-
	LEFT	W98R91G180-CS	W98R92G180-CS	W98R93G180-CS	-	-	-	-	-	-

These codes mean complete curve, except floor supports and gearmotor, if you need to include them please see page 25-26.

# ZERO<sup>PRO</sup>CONTACT

## CURVE CONVEYOR TWO TRACKS VERSION

### Product use

The **Zero Contact™ PRO** is available also with “two-tracks” design; by keeping the same advantages of the **Zero Contact™ PRO**, with the **Zero Contact™ PRO “two tracks”** the maximum working load can be even higher thanks to the increased number of bearings. Moreover, the two belts can work at different / independent speeds and can be activated independently thanks to the double shaft.

The two belts can also be used for accelerating goods or can be also stopped independently, in case there is a double track infeed conveyor.



Separate belts offers the possibility of different/ higher speeds



2 different bearing-tracks guarantee extreme load, even at higher speed



**INNER RADIUS** 586mm ÷ 1011mm (23.1" ÷ 39.8")

**BELT WIDTH** 524mm ÷ 1034mm (20.6" ÷ 40.7")

**MATERIAL OF MODULES**

Polyamide glass fiber reinforced (PA)

**COLOR OF MODULES**

Dark Pigeon Blue (RAL 5017)

**PINS** Stainless steel

**PIN LOCK** Stainless steel grub screws

**FRAME** Stainless steel

**TEMPERATURE RANGE**

Dry: -30°C ÷ 100°C Wet: n.a.

(Dry: -22°F ÷ 212°F Wet: n.a.)

**MAX. WORKING LOAD**

21.000N/m belt width (1.450 lb/ft belt width)

**CURVE ANGLE** 15° ÷ 360°

**OPEN AREA** 0%

# CURVES RANGE

Angle 90°  
Double-Shaft

Left Version **CS2**

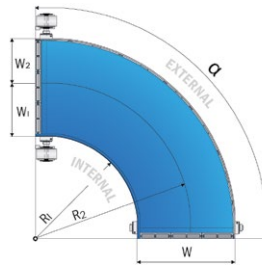

**CD2** Right Version

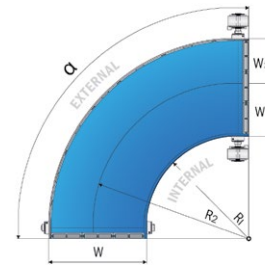

Width	Version	Rmin. 586mm (23.1")	Rmin. 756mm (29.8")	Rmin. 1011mm (39.8")
524mm (20.6")	RIGHT	-	P-W96R92G090-CD2	P-W96R93G090-CD2
	LEFT	-	P-W96R92G090-CS2	P-W96R93G090-CS2
864mm (34")	RIGHT	P-W97R91G090-CD2	P-W97R92G090-CD2	P-W97R93G090-CD2
	LEFT	P-W97R91G090-CS2	P-W97R92G090-CS2	P-W97R93G090-CS2
1034mm (40.7")	RIGHT	P-W98R91G090-CD2	P-W98R92G090-CD2	P-W98R93G090-CD2
	LEFT	P-W98R91G090-CS2	P-W98R92G090-CS2	P-W98R93G090-CS2

CODE	R1 - mm (")	W1 - mm (")	R2 - mm (")	W2 - mm (")	WTot - mm (")
P-W96R92G090-CD2 (CS2)	756 (29.8)	269 (10.6)	1031 (40.6)	249 (9.8)	524 (20.6)
P-W96R93G090-CD2 (CS2)	1011 (39.8)	269 (10.6)	1286 (50.6)	249 (9.8)	524 (20.6)
P-W97R91G090-CD2 (CS2)	586 (23.1)	439 (17.3)	1031 (40.6)	419 (16.5)	864 (34)
P-W97R92G090-CD2 (CS2)	756 (29.8)	439 (17.3)	1201 (47.3)	419 (16.5)	864 (34)
P-W97R93G090-CD2 (CS2)	1011 (39.8)	439 (17.3)	1456 (57.3)	419 (16.5)	864 (34)
P-W98R91G090-CD2 (CS2)	586 (23.1)	524 (20.6)	1116 (43.9)	504 (19.8)	1034 (40.7)
P-W98R92G090-CD2 (CS2)	756 (29.8)	524 (20.6)	1286 (50.6)	504 (19.8)	1034 (40.7)
P-W98R93G090-CD2 (CS2)	1011 (39.8)	524 (20.6)	1541 (60.7)	504 (19.8)	1034 (40.7)

The gap between the two belts is always 6mm

These codes mean complete curve, except floor supports and gearmotors, if you need to include them please see page 25-26.

# CURVES RANGE

Angle 180°  
Double-Shaft

Left Version **CS2**

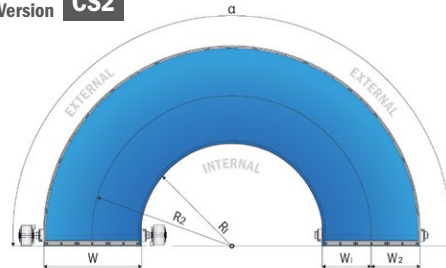

**CD2** Right Version

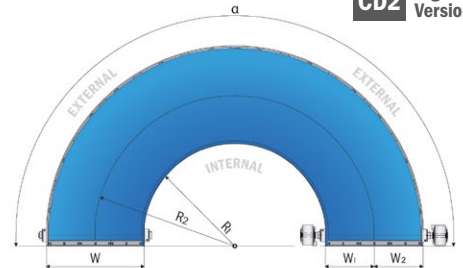

Width	Version	Rmin. 586mm (23.1")	Rmin. 756mm (29.8")	Rmin. 1011mm (39.8")
524mm (20.6")	RIGHT	-	P-W96R92G180-CD2	P-W96R93G180-CD2
	LEFT	-	P-W96R92G180-CS2	P-W96R93G180-CS2
864mm (34")	RIGHT	P-W97R91G180-CD2	P-W97R92G180-CD2	P-W97R93G180-CD2
	LEFT	P-W97R91G180-CS2	P-W97R92G180-CS2	P-W97R93G180-CS2
1034mm (40.7")	RIGHT	P-W98R91G180-CD2	P-W98R92G180-CD2	P-W98R93G180-CD2
	LEFT	P-W98R91G180-CS2	P-W98R92G180-CS2	P-W98R93G180-CS2

CODE	R1 - mm (")	W1 - mm (")	R2 - mm (")	W2 - mm (")	WTot - mm (")
P-W96R92G090-CD2 (CS2)	756 (29.8)	269 (10.6)	1031 (40.6)	249 (9.8)	524 (20.6)
P-W96R93G090-CD2 (CS2)	1011 (39.8)	269 (10.6)	1286 (50.6)	249 (9.8)	524 (20.6)
P-W97R91G090-CD2 (CS2)	586 (23.1)	439 (17.3)	1031 (40.6)	419 (16.5)	864 (34)
P-W97R92G090-CD2 (CS2)	756 (29.8)	439 (17.3)	1201 (47.3)	419 (16.5)	864 (34)
P-W97R93G090-CD2 (CS2)	1011 (39.8)	439 (17.3)	1456 (57.3)	419 (16.5)	864 (34)
P-W98R91G090-CD2 (CS2)	586 (23.1)	524 (20.6)	1116 (43.9)	504 (19.8)	1034 (40.7)
P-W98R92G090-CD2 (CS2)	756 (29.8)	524 (20.6)	1286 (50.6)	504 (19.8)	1034 (40.7)
P-W98R93G090-CD2 (CS2)	1011 (39.8)	524 (20.6)	1541 (60.7)	504 (19.8)	1034 (40.7)

The gap between the two belts is always 6mm

These codes mean complete curve, except floor supports and gearmotors, if you need to include them please see page 25-26.

# ZER<sup>510</sup>ATP

## ACTIVE TRANSFER PLATE

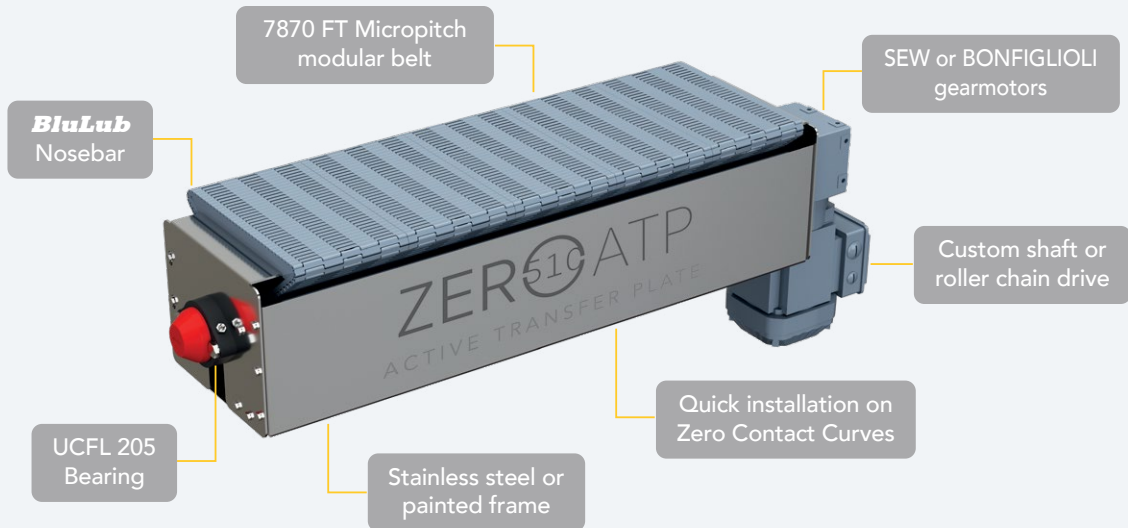

The **Zero ATP** is the perfect solution for small and light products, which hardly slide on standard solution. With the Active Transfer Plate Movex helps reducing downtimes and improving efficiency.

**Zero ATP** is a complete conveyor unit and supplied connected to the **Zero Contact**™ curve independently, so speed can be different than the curve itself, so able to accelerate or decelerate carried products.

**Zero ATP Active Transfer Plates** are equipped with Movex 7870 FT micropitch belt. A tensioning system is included.

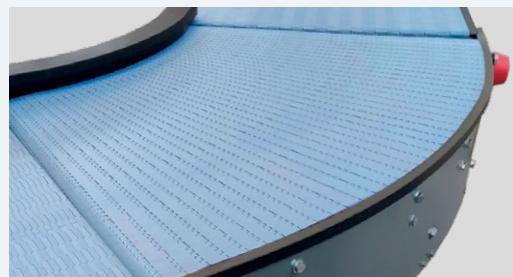

### Main features

- Equipped with Movex 7870 modular belt
- 8mm pitch, 3mm nose radius
- Available length 250mm and 500mm
- Connectable to Zero Contact curves



See page 24

For different configurations and 7870 modular belt surface (Flush grid, Diamond top, Cone top, Non slip), please contact your sales representative.

## Zero Contact - Zero Contact Flat Edge - Zero Contact Hygienic

Module length 250mm (10 inches)

Article Nr.	Curve Width - mm (")	Micropitch Width - mm (")
W02L10ATP	200 (7.9)	228,6 (9)
W04L10ATP	400 (15.7)	381 (15)
W06L10ATP	600 (23.6)	609,6 (24)
W08L10ATP	800 (31.5)	838,2 (33)
W10L10ATP	1000 (39.4)	990,6 (39)
W12L10ATP	1200 (47.2)	1219,2 (48)
W14L10ATP	1400 (55.1)	1447,8 (57)
W16L10ATP	1600 (63)	1600,2 (63)

Module length 500mm (20 inches)

Article Nr.	Curve Width - mm (")	Micropitch Width - mm (")
W02L20ATP	200 (7.9)	228,6 (9)
W04L20ATP	400 (15.7)	381 (15)
W06L20ATP	600 (23.6)	609,6 (24)
W08L20ATP	800 (31.5)	838,2 (33)
W10L20ATP	1000 (39.4)	990,6 (39)
W12L20ATP	1200 (47.2)	1219,2 (48)
W14L20ATP	1400 (55.1)	1447,8 (57)
W16L20ATP	1600 (63)	1600,2 (63)

## Zero Contact PRO

Module length 250mm (10 inches)

Article Nr.	Curve Width - mm (")	Micropitch Width - mm (")
W91L10ATP	249 (9.8)	228,6 (9)
W92L10ATP	269 (10.6)	228,6 (9)
W93L10ATP	419 (16.5)	381 (15)
W94L10ATP	439 (17.3)	457,2 (18)
W95L10ATP	504 (19.8)	533,4 (21)
W96L10ATP	524 (20.6)	533,4 (21)
W97L10ATP	864 (34)	838,2 (33)
W98L10ATP	1034 (40.7)	990,6 (39)

Module length 500mm (20 inches)

Article Nr.	Curve Width - mm (")	Micropitch Width - mm (")
W91L20ATP	249 (9.8)	228,6 (9)
W92L20ATP	269 (10.6)	228,6 (9)
W93L20ATP	419 (16.5)	381 (15)
W94L20ATP	439 (17.3)	457,2 (18)
W95L20ATP	504 (19.8)	533,4 (21)
W96L20ATP	524 (20.6)	533,4 (21)
W97L20ATP	864 (34)	838,2 (33)
W98L20ATP	1034 (40.7)	990,6 (39)

## Zero Contact S

Module length 250mm (10 inches)

Article Nr.	Curve Width - mm (")	Micropitch Width - mm (")
W02L10ATPS	200 (7.9)	228,6 (9)
W04L10ATPS	400 (15.7)	381 (15)
W06L10ATPS	600 (23.6)	609,6 (24)
W08L10ATPS	800 (31.5)	838,2 (33)
W10L10ATPS	1000 (39.4)	990,6 (39)
W12L10ATPS	1200 (47.2)	1219,2 (48)
W14L10ATPS	1400 (55.1)	1447,8 (57)
W16L10ATPS	1600 (63)	1600,2 (63)

Module length 500mm (20 inches)

Article Nr.	Curve Width - mm (")	Micropitch Width - mm (")
W02L20ATPS	200 (7.9)	228,6 (9)
W04L20ATPS	400 (15.7)	381 (15)
W06L20ATPS	600 (23.6)	609,6 (24)
W08L20ATPS	800 (31.5)	838,2 (33)
W10L20ATPS	1000 (39.4)	990,6 (39)
W12L20ATPS	1200 (47.2)	1219,2 (48)
W14L20ATPS	1400 (55.1)	1447,8 (57)
W16L20ATPS	1600 (63)	1600,2 (63)

### SEW gearmotor

- Foodgrade oil
- Power 0,18kW

Article Nr.	Power
MDT-1600	0,18kW



### BONFIGLIOLI gearmotor

- Power 0,18kW

Article Nr.	Power
MDTL-1600	0,18kW



For different gearmotors please contact your sales representative

SEW and BONFIGLIOLI are believed to be the trademarks and/or trade names of their respective owners and are not owned or controlled by Movex S.p.A.

# ZERO<sup>520</sup>CONTACT + ZERO<sup>PRO</sup>ATP<sup>®</sup>

THE EFFECTIVE COMBINATION

- 1 MINIMIZED TRANSFER**  
Up to **70%** reduced transfer.
- 2 USER-FRIENDLINESS**  
Easy installation and interchangeability.
- 3 SAVING (ENERGY, RESOURCES, TIME)**  
Fewer resources and time employed.
- 4 SAFER DESIGN**  
Minimized the possibility of injuries.



**Connection**  
Roller chain transmission (optional).

The combination of **Zero Contact™** and the active transfer plate **Zero ATP Pro®** allows to connect different conveyors, guaranteeing a smooth product transfer, that can be easily integrated into existing lines by replacing traditional transfers, with limited structural work.

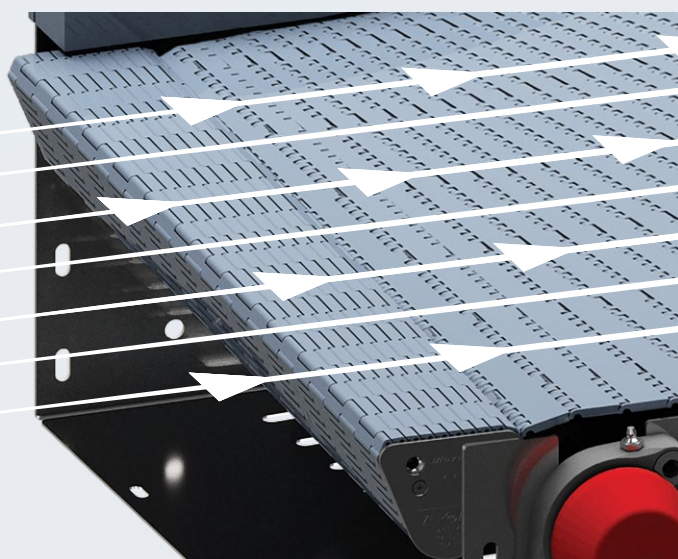
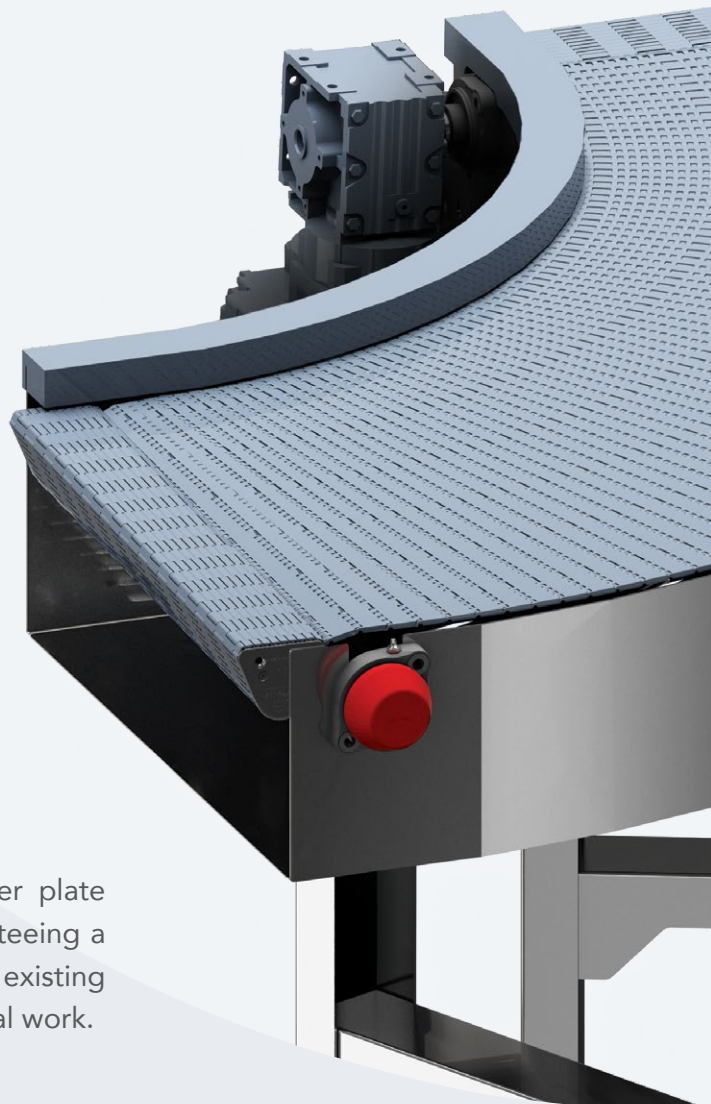

## ZERO ATP PRO

<b>BELT WIDTH:</b>	152,4 mm÷1066,8 mm
<b>MAX. WORKING LOAD:</b>	3000 N/m
<b>TEMPERATURE RANGE:</b>	Dry -40÷120 °C   Wet -40÷65 °C
<b>MATERIALS AVAILABLE:</b>	LFA, MX, LFB
<b>MODULAR BELT:</b>	7870 FT Micro pitch (8 mm)
<b>OPEN AREA:</b>	0 %
<b>TRANSFER LENGTH:</b>	80 or 150 mm

## ZERO CONTACT

<b>BELT WIDTH:</b>	200 mm÷1600 mm
<b>MAX. WORKING LOAD:</b>	13.500 N/m belt width
<b>TEMPERATURE RANGE:</b>	Dry -40÷80 °C   Wet -40÷65 °C
<b>MATERIAL OF MODULES:</b>	Acetal (POM)
<b>COLOR OF MODULES:</b>	Pigeon Blue (RAL 5014)
<b>CURVE ANGLE:</b>	15°÷360°
<b>INNER RADIUS:</b>	600 mm÷2000 mm

Ask your sales representative for more information and a tailor-made quotation.



# Zero Contact™

## Floor Support

### Standard floor supports:

- Stainless steel AISI 304 or painted steel
- Single or double floor fixation levers
- Customizable height

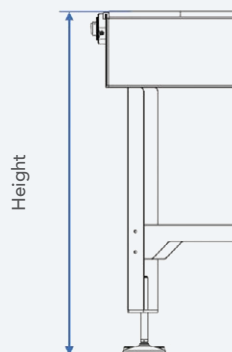

### Floor support for Zero Contact - Zero Contact Flat Edge - Zero Contact Hygienic

Article Nr.	Curve Width - mm (")	Total Height - mm (")	Angle	Article Nr.	Curve Width - mm (")	Total Height - mm (")	Angle
W02G090H	200 (7.9)	1000 (39.4)	90°	W02G180H	200 (7.9)	1000 (39.4)	180°
W04G090H	400 (15.7)	1000 (39.4)	90°	W04G180H	400 (15.7)	1000 (39.4)	180°
W06G090H	600 (23.6)	1000 (39.4)	90°	W06G180H	600 (23.6)	1000 (39.4)	180°
W08G090H	800 (31.5)	1000 (39.4)	90°	W08G180H	800 (31.5)	1000 (39.4)	180°
W10G090H	1000 (39.4)	1000 (39.4)	90°	W10G180H	1000 (39.4)	1000 (39.4)	180°
W12G090H	1200 (47.2)	1000 (39.4)	90°	W12G180H	1200 (47.2)	1000 (39.4)	180°
W14G090H	1400 (55.1)	1000 (39.4)	90°	W14G180H	1400 (55.1)	1000 (39.4)	180°
W16G090H	1600 (63)	1000 (39.4)	90°	W16G180H	1600 (63)	1000 (39.4)	180°

To order floor support for Hygienic version, add 'H' to the end of the code in the table.

### Floor support for Zero Contact PRO

Article Nr.	Curve Width - mm (")	Total Height - mm (")	Angle	Article Nr.	Curve Width - mm (")	Total Height - mm (")	Angle
W91G090H	249 (9.8)	1000 (39.4)	90°	W91G180H	249 (9.8)	1000 (39.4)	180°
W92G090H	269 (10.6)	1000 (39.4)	90°	W92G180H	269 (10.6)	1000 (39.4)	180°
W93G090H	419 (16.5)	1000 (39.4)	90°	W93G180H	419 (16.5)	1000 (39.4)	180°
W94G090H	439 (17.3)	1000 (39.4)	90°	W94G180H	439 (17.3)	1000 (39.4)	180°
W95G090H	504 (19.8)	1000 (39.4)	90°	W95G180H	504 (19.8)	1000 (39.4)	180°
W96G090H	524 (20.6)	1000 (39.4)	90°	W96G180H	524 (20.6)	1000 (39.4)	180°
W97G090H	864 (34)	1000 (39.4)	90°	W97G180H	864 (34)	1000 (39.4)	180°
W98G090H	1034 (40.7)	1000 (39.4)	90°	W98G180H	1034 (40.7)	1000 (39.4)	180°

### Floor support for Zero Contact S

Article Nr.	Curve Width - mm (")	Total Height - mm (")	Angle	Article Nr.	Curve Width - mm (")	Total Height - mm (")	Angle
W02G090HS	200 (7.9)	1000 (39.4)	90°	W02G180HS	200 (7.9)	1000 (39.4)	180°
W04G090HS	400 (15.7)	1000 (39.4)	90°	W04G180HS	400 (15.7)	1000 (39.4)	180°
W06G090HS	600 (23.6)	1000 (39.4)	90°	W06G180HS	600 (23.6)	1000 (39.4)	180°
W08G090HS	800 (31.5)	1000 (39.4)	90°	W08G180HS	800 (31.5)	1000 (39.4)	180°
W10G090HS	1000 (39.4)	1000 (39.4)	90°	W10G180HS	1000 (39.4)	1000 (39.4)	180°
W12G090HS	1200 (47.2)	1000 (39.4)	90°	W12G180HS	1200 (47.2)	1000 (39.4)	180°
W14G090HS	1400 (55.1)	1000 (39.4)	90°	W14G180HS	1400 (55.1)	1000 (39.4)	180°
W16G090HS	1600 (63)	1000 (39.4)	90°	W16G180HS	1600 (63)	1000 (39.4)	180°

For different heights or custom specification please contact your sales representative

# Zero Contact™

## Gearmotor



### SEW Gearmotors

- Foodgrade oil
- Power for 90° curve → 0,37kW – type WA30 DRN71M4
- Power for 180° curve → 0,55kW – type WA30 DRN80MK4
- Internal shaft position (no cable supplied)

Article Nr.	Power
M090-S/I	for 90° curve
M180-S/I	for 180° curve

Recommended for **Zero Contact™**, **Zero Contact™ PRO**, **Zero Contact Flat Edge™** and **Zero Contact Hygienic™**

For different gearmotors please contact your sales representative



### BONFIGLIOLI Gearmotors

- Power for 90° curve → 0,37kW – type BN 71B 4 B14 KW 0,37
- Power for 180° curve → 0,55kW – type BN 71C 4 B14 KW 0,55
- Internal shaft position (no cable supplied)

Article Nr.	Power
M090L-S/I	for 90° curve
M180L-S/I	for 180° curve

Recommended for **Zero Contact™ S**

For different gearmotors please contact your sales representative

SEW and BONFIGLIOLI are believed to be the trademarks and/or trade names of their respective owners and are not owned or controlled by Movex S.p.A.

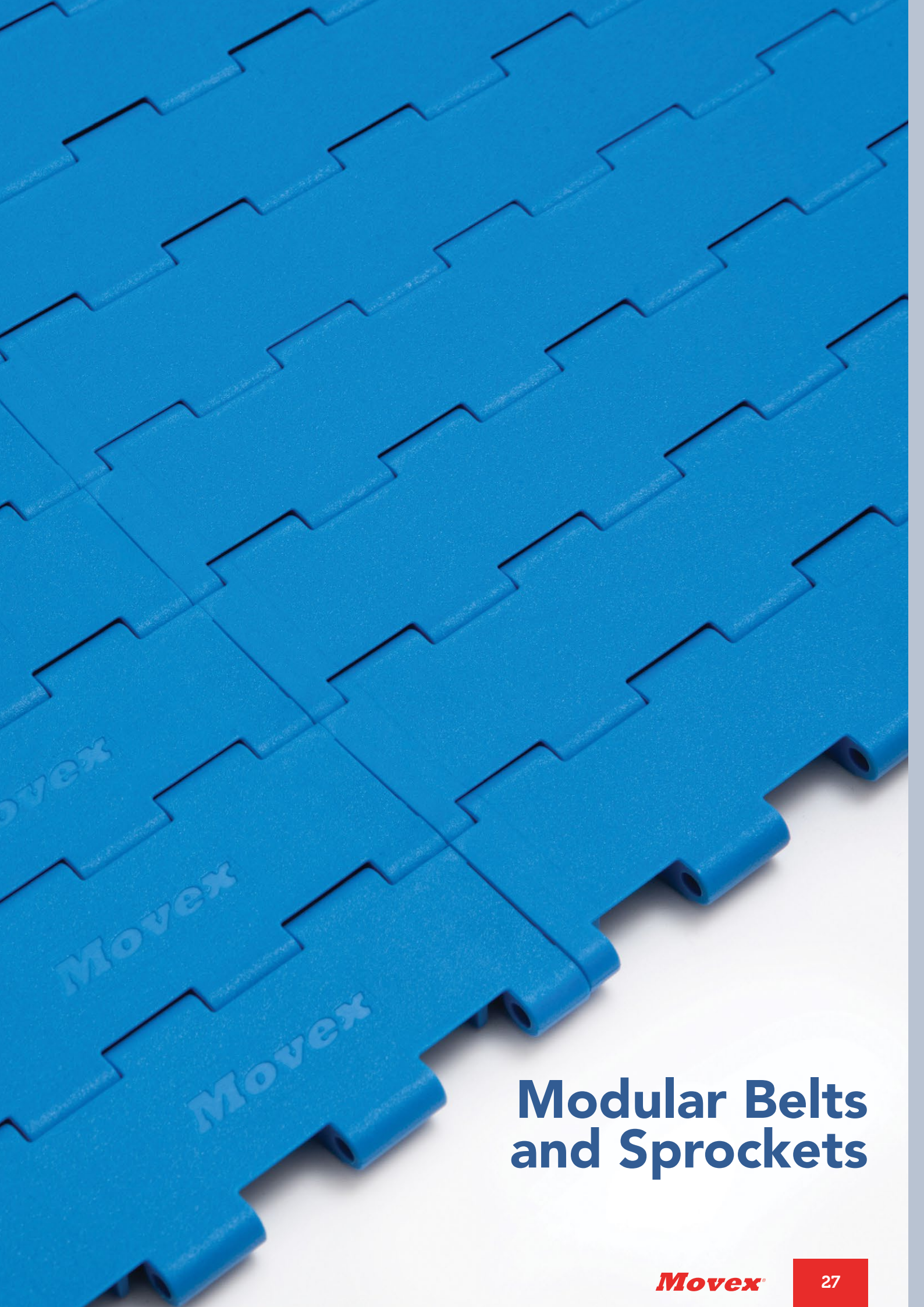

# Modular Belts and Sprockets

# ZER<sup>520</sup>CONTACT

## SIDE FLEX MODULAR BELT



**Movex<sup>®</sup> Zero Contact<sup>™</sup>** modular fixed radius curve belt it's the best choice for all type of transportation, for beverage, food and logistic industries, thanks for its versatility. It offers high performances, reducing the coefficient of friction between the product and running belt surface and improves the efficiency line, by minimizing downtimes.

A wide range of radii and widths helps finding the right solution for every product dimension and transportation condition, from light packages to heavier ones. Installation and maintenance have never been so easy, so far.

*FDA approved.*

## Design details

### Wide range available

- **Inner radius:** 600mm ÷ 2000mm (23.6" ÷ 78.7")
- **Belt width:** 200mm ÷ 1600mm (7.9" ÷ 63")
- **Angle:** 90° and 180°

### Features

- **Row to row angle:** 1,33°
- **Pin:** D4,7mm, PBT White
- **Material of the modules:** LFA (POM)
- **Color of the modules:** Pigeon Blue
- **Open Area:** 0%
- **Max Working Load:** 13.500 N/m (924 lb/ft belt width)



Low coefficient of friction



Minimized maintenance



Easy pin removal

Material abbreviation	Material	Chemical abbreviation	Product Material						FDA Approval
			Fahrenheit			Celsius			
			Min	Max		Min	Max		
				Dry	Wet		Dry	Wet	
LFA	Low friction acetal	POM	-40	176	149	-40	80	65	YES

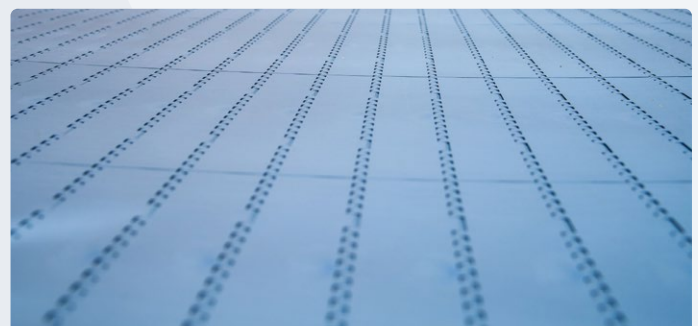

# Order code for 90°

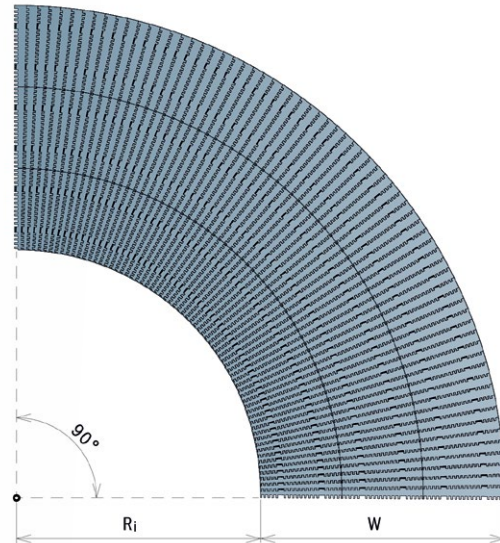
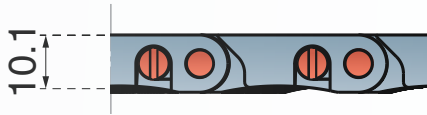

Side Flex Modular Belt Zero Contact™ 90° | Length of the belt 150 Modules

Part	Belt Width	Rmin. 600mm (23.6")	Rmin. 800mm (31.5")	Rmin. 1000mm (39.4")	Rmin. 1200mm (47.2")	Rmin. 1400mm (55.1")	Rmin. 1600mm (63")	Rmin. 1800mm (70.8")	Rmin. 2000mm (78.7")
545	200mm (7.9")	5451010201A	5451010202A	5451010203A	5451010204A	5451010205A	5451010206A	5451010207A	5451010208A
545	400mm (15.7")	5451010401A	5451010402A	5451010403A	5451010404A	5451010405A	5451010406A	5451010407A	-
545	600mm (23.6")	5451010601A	5451010602A	5451010603A	5451010604A	5451010605A	5451010606A	-	-
545	800mm (31.5")	5451010801A	5451010802A	5451010803A	5451010804A	5451010805A	-	-	-
545	1000mm (39.4")	5451011001A	5451011002A	5451011003A	5451011004A	-	-	-	-
545	1200mm (47.2")	5451011201A	5451011202A	5451011203A	-	-	-	-	-
545	1400mm (55.1")	5451011401A	5451011402A	-	-	-	-	-	-
545	1600mm (63")	5451011601A	-	-	-	-	-	-	-

# Order code for 180°

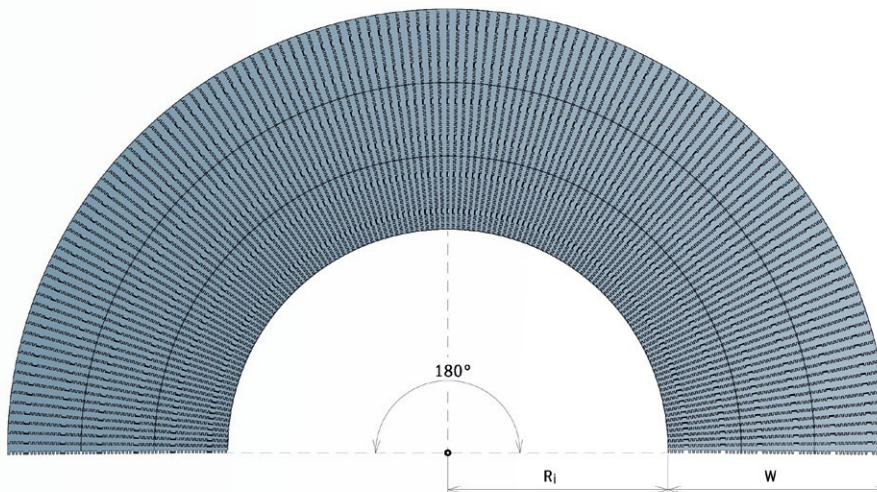

Side Flex Modular Belt Zero Contact™ 180° | Length of the belt 285 Modules

Part	Belt Width	Rmin. 600mm (23.6")	Rmin. 800mm (31.5")	Rmin. 1000mm (39.4")	Rmin. 1200mm (47.2")	Rmin. 1400mm (55.1")	Rmin. 1600mm (63")	Rmin. 1800mm (70.8")	Rmin. 2000mm (78.7")
545	200mm (7.9")	5452010201A	5452010202A	5452010203A	5452010204A	5452010205A	5452010206A	5452010207A	5452010208A
545	400mm (15.7")	5452010401A	5452010402A	5452010403A	5452010404A	5452010405A	5452010406A	5452010407A	-
545	600mm (23.6")	5452010601A	5452010602A	5452010603A	5452010604A	5452010605A	5452010606A	-	-
545	800mm (31.5")	5452010801A	5452010802A	5452010803A	5452010804A	5452010805A	-	-	-
545	1000mm (39.4")	5452011001A	5452011002A	5452011003A	5452011004A	-	-	-	-
545	1200mm (47.2")	5452011201A	5452011202A	5452011203A	-	-	-	-	-
545	1400mm (55.1")	5452011401A	5452011402A	-	-	-	-	-	-
545	1600mm (63")	5452011601A	-	-	-	-	-	-	-

# ZERO PRO CONTACT

## SIDE FLEX MODULAR BELT



The innovative design of **Movex® Zero Contact™ PRO** is especially recommended for high speed, heavy loads and transportation of abrasive substances, like sand, salt, sugar, and many other applications. The stainless steel pins guarantee a higher working load, and due to the new pin retention with grub screw, this permits a strong assembling of the belt. The robust structure of **Zero Contact™ PRO** can be summarized in minimal maintenance, long life expectation and high reliability.

**Zero Contact™ PRO** is a surprisingly versatile belt, allowing a wider range of available widths and radii. Find out also our "two-tracks" version.

## Design details

### Wide range available

- **Inner radius:** 586mm ÷ 1541mm (23.1" ÷ 60.7")
- **Belt width:** 249mm ÷ 1034mm (9.8" ÷ 40.7")
- **Angle:** 90° and 180° (different on request)

### Features

- **Row to row angle:** 1°
- **Pin:** D4mm, material 1.4301
- **Material of the modules:** PA glass fiber reinforced
- **Color of the modules:** Dark Pigeon Blue
- **Open Area:** 0%
- **Max Working Load:** 19.000 N/m (1.300 lb/ft belt width)



Extreme speed



Heavy duty



High abrasion resistance

Material abbreviation	Material	Chemical abbreviation	Product Material						FDA Approval
			Fahrenheit			Celsius			
			Min	Max		Min	Max		
				Dry	Wet		Dry	Wet	
PA	PA glass fiber reinforced	PA	-22	212	n.a.	-30	100	n.a.	NO

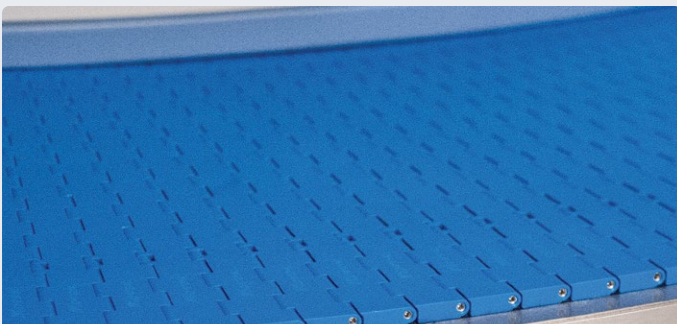

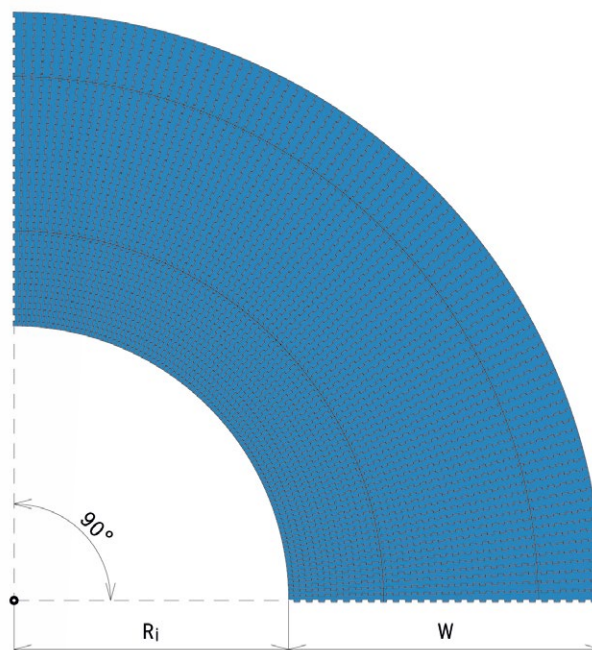
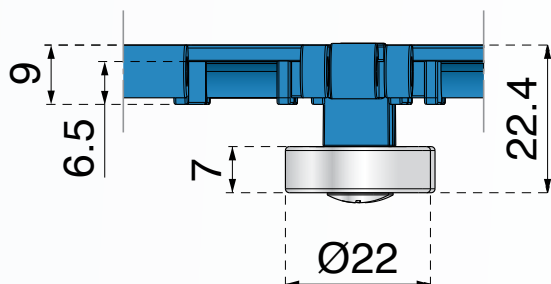

**Side Flex Modular Belt Zero Contact PRO™ 90°** | Without bearings | Length of the belt 200 modules

Order code	R1 - mm(“)	W - mm(“)	Order code	R1 - mm(“)	W - mm(“)	Order code	R1 - mm(“)	W - mm(“)
5461280439A-M	586 (23.1)	439 (17.3)	5462281034A-M	756 (29.8)	1034 (40.7)	5464280504A-M	1116 (43.9)	504 (19.8)
5461280524A-M	586 (23.1)	524 (20.6)	5463280269A-M	1011 (39.8)	269 (10.6)	5465280419A-M	1201 (47.3)	419 (16.5)
5461280864A-M	586 (23.1)	864 (34)	5463280439A-M	1011 (39.8)	439 (17.3)	5466280249A-M	1286 (50.6)	249 (9.8)
5461281034A-M	586 (23.1)	1034 (40.7)	5463280524A-M	1011 (39.8)	524 (20.6)	5465280504A-M	1286 (50.6)	504 (19.8)
5462280269A-M	756 (29.8)	269 (10.6)	5463280864A-M	1011 (39.8)	864 (34)	5466280419A-M	1456 (57.3)	419 (16.5)
5462280439A-M	756 (29.8)	439 (17.3)	5463281034A-M	1011 (39.8)	1034 (40.7)	5466280504A-M	1541 (60.7)	504 (19.8)
5462280524A-M	756 (29.8)	524 (20.6)	5465280249A-M	1031 (40.6)	249 (9.8)			
5462280864A-M	756 (29.8)	864 (34)	5464280419A-M	1031 (40.6)	419 (16.5)			

**Side Flex Modular Belt Zero Contact PRO™ 90°** | With bearings | Length of the belt 200 modules

Order code	R1 - mm(“)	W - mm(“)	Order code	R1 - mm(“)	W - mm(“)
5462280249A-M	1031 (40.6)	249 (9.8)	5463280249A-M	1286 (50.6)	249 (9.8)
5461280419A-M	1031 (40.6)	419 (16.5)	5462280504A-M	1286 (50.6)	504 (19.8)
5461280504A-M	1116 (43.9)	504 (19.8)	5463280419A-M	1456 (57.3)	419 (16.5)
5462280419A-M	1201 (47.3)	419 (16.5)	5463280504A-M	1541 (60.7)	504 (19.8)



**Side Flex Modular Belt Zero Contact PRO™ 90°** | Two track combinations | Length of the belts 200 modules

Track 1 - Order code	R1 - mm(“)	W - mm(“)		Track 2 - Order code	R1 - mm(“)	W - mm(“)	Total width
5462280269A-M	756 (29.8)	269 (10.6)	+	5462280249A-M	1031 (40.6)	249 (9.8)	524 (20.6)
5463280269A-M	1011 (39.8)	269 (10.6)	+	5463280249A-M	1286 (50.6)	249 (9.8)	524 (20.6)
5461280439A-M	586 (23.1)	439 (17.3)	+	5461280419A-M	1031 (40.6)	419 (16.5)	864 (34)
5462280439A-M	756 (29.8)	439 (17.3)	+	5462280419A-M	1201 (47.3)	419 (16.5)	864 (34)
5463280439A-M	1011 (39.8)	439 (17.3)	+	5463280419A-M	1456 (57.3)	419 (16.5)	864 (34)
5461280524A-M	586 (23.1)	524 (20.6)	+	5461280504A-M	1116 (43.9)	504 (19.8)	1034 (40.7)
5462280524A-M	756 (29.8)	524 (20.6)	+	5462280504A-M	1286 (50.6)	504 (19.8)	1034 (40.7)
5463280524A-M	1011 (39.8)	524 (20.6)	+	5463280504A-M	1541 (60.7)	504 (19.8)	1034 (40.7)

The gap between the belts is 6 mm.  
Track 1 belt is supplied without bearings.

Track 2 belt is supplied with bearings.

# Order code for 180°

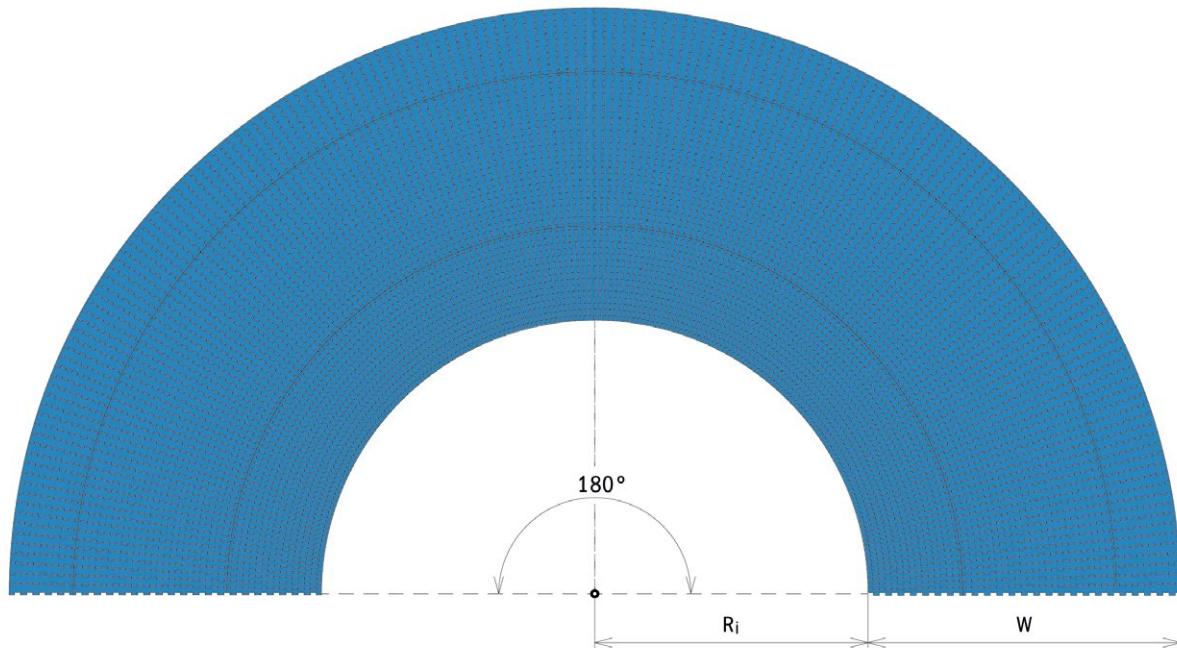

## Side Flex Modular Belt Zero Contact PRO™ 180° | Without bearings | Length of the belt 380 modules

Order code	R1 - mm(“)	W - mm(“)	Order code	R1 - mm(“)	W - mm(“)	Order code	R1 - mm(“)	W - mm(“)
5461280439B-M	586 (23.1)	439 (17.3)	5462281034B-M	756 (29.8)	1034 (40.7)	5464280504B-M	1116 (43.9)	504 (19.8)
5461280524B-M	586 (23.1)	524 (20.6)	5463280269B-M	1011 (39.8)	269 (10.6)	5465280419B-M	1201 (47.3)	419 (16.5)
5461280864B-M	586 (23.1)	864 (34)	5463280439B-M	1011 (39.8)	439 (17.3)	5466280249B-M	1286 (50.6)	249 (9.8)
5461281034B-M	586 (23.1)	1034 (40.7)	5463280524B-M	1011 (39.8)	524 (20.6)	5465280504B-M	1286 (50.6)	504 (19.8)
5462280269B-M	756 (29.8)	269 (10.6)	5463280864B-M	1011 (39.8)	864 (34)	5466280419B-M	1456 (57.3)	419 (16.5)
5462280439B-M	756 (29.8)	439 (17.3)	5463281034B-M	1011 (39.8)	1034 (40.7)	5466280504B-M	1541 (60.7)	504 (19.8)
5462280524B-M	756 (29.8)	524 (20.6)	5465280249B-M	1031 (40.6)	249 (9.8)			
5462280864B-M	756 (29.8)	864 (34)	5464280419B-M	1031 (40.6)	419 (16.5)			

## Side Flex Modular Belt Zero Contact PRO™ 180° | With bearings | Length of the belt 380 modules

Order code	R1 - mm(“)	W - mm(“)	Order code	R1 - mm(“)	W - mm(“)
5462280249B-M	1031 (40.6)	249 (9.8)	5463280249B-M	1286 (50.6)	249 (9.8)
5461280419B-M	1031 (40.6)	419 (16.5)	5462280504B-M	1286 (50.6)	504 (19.8)
5461280504B-M	1116 (43.9)	504 (19.8)	5463280419B-M	1456 (57.3)	419 (16.5)
5462280419B-M	1201 (47.3)	419 (16.5)	5463280504B-M	1541 (60.7)	504 (19.8)



## Side Flex Modular Belt Zero Contact PRO™ 180° | Two track combinations | Length of the belts 380 modules

Track 1 - Order code	R1 - mm(“)	W - mm(“)		Track 2 - Order code	R1 - mm(“)	W - mm(“)	Total width
5462280269B-M	756 (29.8)	269 (10.6)	+	5462280249B-M	1031 (40.6)	249 (9.8)	524 (20.6)
5463280269B-M	1011 (39.8)	269 (10.6)	+	5463280249B-M	1286 (50.6)	249 (9.8)	524 (20.6)
5461280439B-M	586 (23.1)	439 (17.3)	+	5461280419B-M	1031 (40.6)	419 (16.5)	864 (34)
5462280439B-M	756 (29.8)	439 (17.3)	+	5462280419B-M	1201 (47.3)	419 (16.5)	864 (34)
5463280439B-M	1011 (39.8)	439 (17.3)	+	5463280419B-M	1456 (57.3)	419 (16.5)	864 (34)
5461280524B-M	586 (23.1)	524 (20.6)	+	5461280504B-M	1116 (43.9)	504 (19.8)	1034 (40.7)
5462280524B-M	756 (29.8)	524 (20.6)	+	5462280504B-M	1286 (50.6)	504 (19.8)	1034 (40.7)
5463280524B-M	1011 (39.8)	524 (20.6)	+	5463280504B-M	1541 (60.7)	504 (19.8)	1034 (40.7)

The gap between the belts is 6 mm.  
Track 1 belt is supplied without bearings.

Track 2 belt is supplied with bearings.



# Drive Sprockets

ZER<sup>520</sup>CONTACT  
SIDE FLEX MODULAR BELT

Drive sprocket, machined

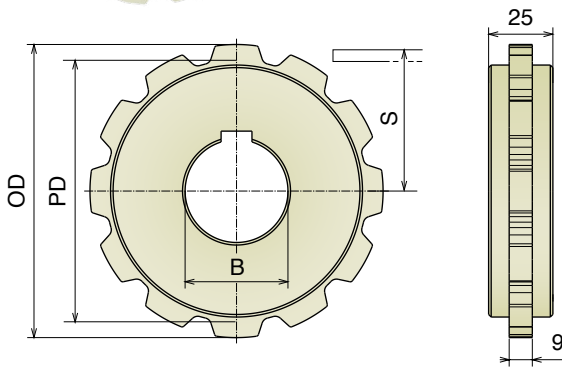

Article-Nr.	Z-	Bore	R <sub>i</sub> +50	PD	OD	S
PA Natural	mm (")	mm (")	mm (")	mm (")	mm (")	mm (")
162401	12	40 (1.57)	650 (25.59)	58 (2.28)	61 (2.4)	25,6 (1.01)
162402			750 (29.53)	66 (2.6)	69 (2.72)	29,9 (1.18)
162403			850 (33.46)	76 (2.99)	79 (3.11)	34,2 (1.35)
162404			950 (37.4)	84 (3.31)	86 (3.39)	38,5 (1.52)
162405			1050 (41.34)	94 (3.7)	97 (3.82)	42,8 (1.69)
162406			1150 (45.28)	102 (4.02)	104 (4.09)	47,1 (1.85)
162407			1250 (49.21)	112 (4.41)	114 (4.49)	51,4 (2.02)
162408			1350 (53.15)	119 (4.69)	122 (4.8)	55,7 (2.19)
162409			1450 (57.09)	130 (5.12)	132 (5.2)	60 (2.36)
162410			1550 (61.02)	137 (5.39)	140 (5.51)	64,3 (2.53)
162411			1650 (64.96)	145 (5.71)	148 (5.83)	68,6 (2.7)
162412			1750 (68.9)	154 (6.06)	157 (6.18)	72,9 (2.87)
162413			1850 (72.83)	163 (6.42)	166 (6.54)	77,2 (3.04)
162414			1950 (76.77)	171 (6.73)	174 (6.85)	81,5 (3.21)
162415			2050 (80.71)	180 (7.09)	183 (7.2)	85,8 (3.38)
162416			2150 (84.65)	189 (7.44)	192 (7.56)	90,1 (3.55)

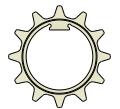
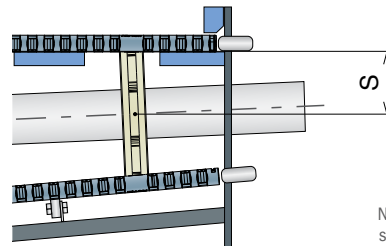

Smallest sprocket with integrated key valid only for code 162401

NOTE: in order to install the smallest sprockets a shaft key way continued to the end of the shaft is required.

ZER<sup>PRO</sup>CONTACT  
SIDE FLEX MODULAR BELT

Drive sprocket, machined

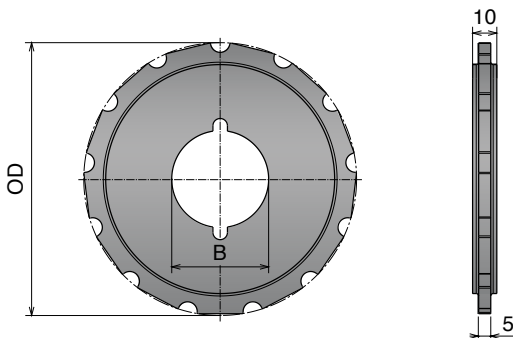

Article-Nr.	Z-	Bore	OD
PA Black	mm (")	mm (")	mm (")
163301	13	30 (1.18)	45,9 (1.81)
163302			52 (2.05)
163303		40 (1.57)	58 (2.28)
163304			64,1 (2.52)
163305			70,2 (2.76)
163306			76,2 (3.0)
163307			82,3 (3.24)
163308			88,3 (3.48)
163309			94,4 (3.72)
163310			100,5 (3.96)
163311			106,6 (4.2)
163312			112,6 (4.43)
163313			118,7 (4.67)
163314			124,7 (4.91)
163315			130,8 (5.15)
163316			136,9 (5.39)
163317			142,9 (5.63)

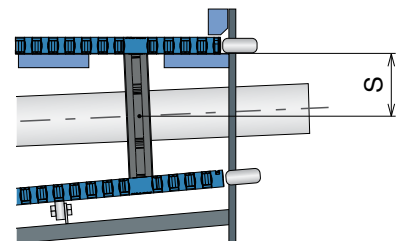

# Curve Conveyor

## Main Dimensions

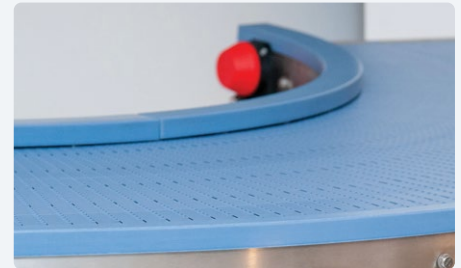
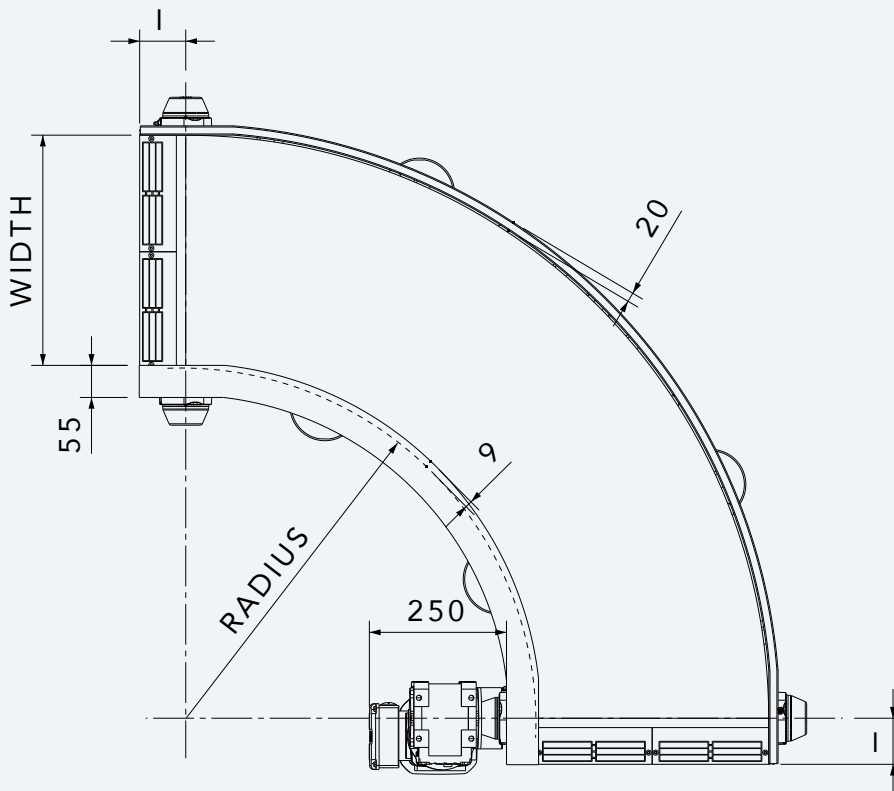

I - Infeed length

3 rollers	4 rollers
80mm	110mm

Length scheme for infeed/outfeed (Zero Contact, Zero Contact S, Zero Contact Flat Edge and Zero Contact Hygienic)

Width	Rmin. 600mm (23.6")	Rmin. 800 (31.5")	Rmin. 1000 (39.4")	Rmin. 1200 (47.2")	Rmin. 1400 (55.1")	Rmin. 1600 (63")	Rmin. 1800 (70.8")	Rmin. 2000 (78.7")
200 (7,9")	3 rollers	3 rollers	3 rollers	3 rollers	4 rollers	4 rollers	4 rollers	4 rollers
400 (15,7")	3 rollers	3 rollers	3 rollers	3 rollers	4 rollers	4 rollers	4 rollers	
600 (23,6")	3 rollers	3 rollers	3 rollers	4 rollers	4 rollers	4 rollers		
800 (31,5")	3 rollers	3 rollers	4 rollers	4 rollers	4 rollers			
1000 (39,4")	3 rollers	4 rollers	4 rollers	4 rollers				
1200 (47,2")	3 rollers	4 rollers	4 rollers					
1400 (55,1")	4 rollers	4 rollers						
1600 (63")	4 rollers							

Length scheme for infeed/outfeed (Zero Contact PRO)

Width	Rmin. 586 (23,1")	Rmin. 756 (29,8")	Rmin. 1011 (39,8")	Rmin. 1031 (40,6")	Rmin. 1116 (43,9")	Rmin. 1201 (47,3")	Rmin. 1286 (50,6")	Rmin. 1456 (57,3")	Rmin. 1541 (60,7")
249 (9.8")				3 rollers			4 rollers	4 rollers	
269 (10.6")		3 rollers	3 rollers						
419 (16.5")				4 rollers		4 rollers		4 rollers	
439 (17.3")	3 rollers	3 rollers	4 rollers						
504 (19.8")					4 rollers		4 rollers		4 rollers
524 (20.6")	4 rollers	4 rollers	4 rollers						
864 (34")	4 rollers	4 rollers	4 rollers						
1034 (40.7")	4 rollers	4 rollers	4 rollers						

If you need technical drawings (pdf, dwg 2D and step 3D) please ask your sales representative.

# Active Transfer Plate

## Main Dimensions

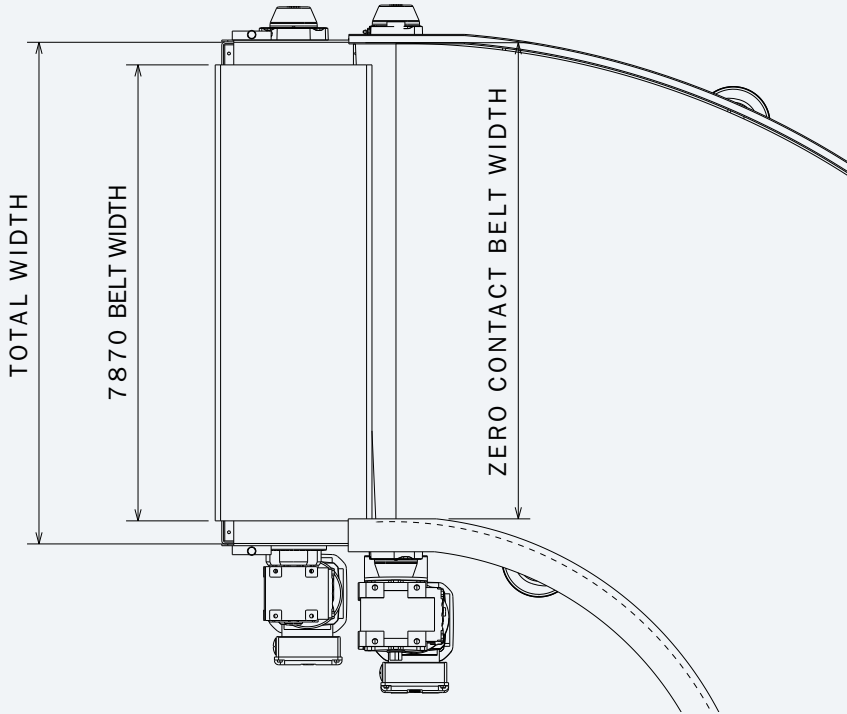

The Zero Contact™ curve, together with the Active Transfer Plate, reduces gap for a perfect and smooth product transfer.

Zero Contact Belt Width*	7870 Belt Width	Total width	Zero Contact PRO Belt Width	7870 Belt Width	Total width
200 (7.9)	228,6 (9)	245 (9.6)	249 (9.8)	228,6 (9)	294 (11.6)
400 (15.7)	381 (15)	445 (17.5)	269 (10.6)	228,6 (9)	314 (12.4)
600 (23.6)	609,6 (24)	645 (25.4)	419 (16.5)	381 (15)	464 (18.3)
800 (31.5)	838,2 (33)	845 (33.3)	439 (17.3)	457,2 (18)	484 (19.1)
1000 (39.4)	990,6 (39)	1045 (41.1)	504 (19.8)	533,4 (21)	549 (21.6)
1200 (47.2)	1219,2 (48)	1245 (49)	524 (20.6)	533,4 (21)	569 (22.4)
1400 (55.1)	1447,8 (57)	1455 (57.3)	864 (34)	838,2 (33)	909 (35.8)
1600 (63)	1600,2 (63)	1645 (64.8)	1034 (40.7)	990,6 (39)	1079 (42.5)

mm (")

mm (")

\*Zero Contact, Zero Contact S, Zero Contact Flat Edge and Zero Contact Hygienic.

If you need technical drawings (pdf, dwg 2D and step 3D) please ask your sales representative.



**Related  
Items**

# Recommended Components - Zero Contact

Conveyor curve with fixed radius can be made using **Movex Zero Contact™** modular belt in combination with the following suggested products. All related details can be found on **Movex** product catalog, on the website [www.movexii.com](http://www.movexii.com) or by asking your sales representative.

**Zero Contact™** conveyor curve **Movex** design may differ from the suggested components. Dedicated related components (machined profiles and sliding curves) are available only for Zero Contact, Zero Contact S and Zero Contact PRO. **Zero Contact™** Flat Edge and **Zero Contact™** Hygienic are exclusive solutions that **Movex** provide only as complete modular solutions.

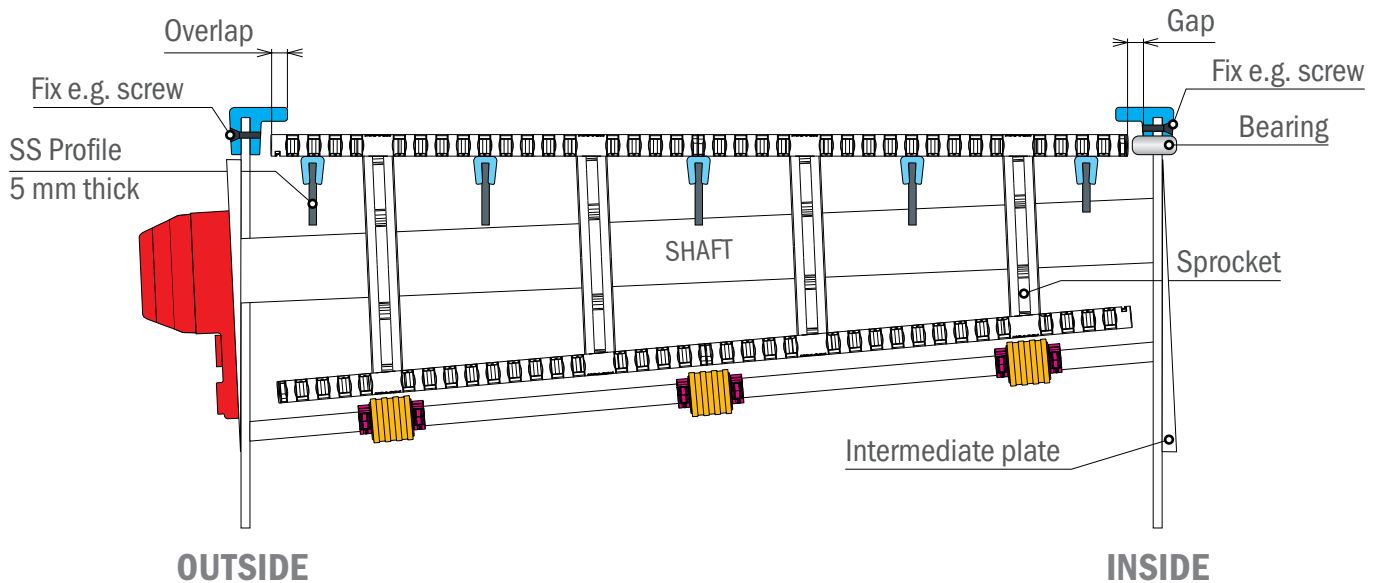

**Profiles**  
**PART 1008**  
 or **PART 700**  
**PART 153**

**Return rollers**  
**PART 220**

**Locking collars**  
**PART 215**

**Flange bearings**  
**PART 826**  
 or **PART 827**

**Part 371**

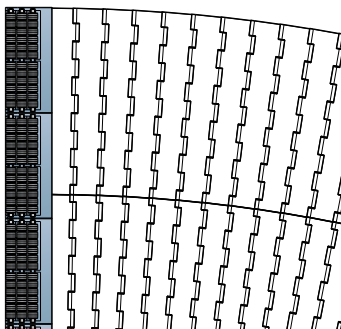

**Part 369**

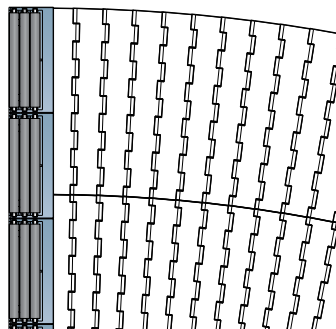

**Part 342**

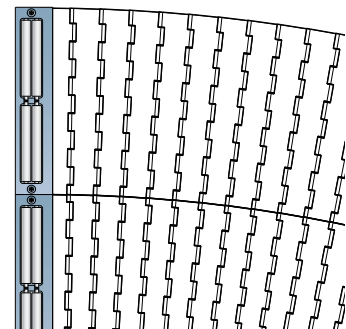

**Transfer modules**

**PART 371**  
 or **PART 369**  
 or **PART 342**

## Return rollers

with rubber D=47 mm

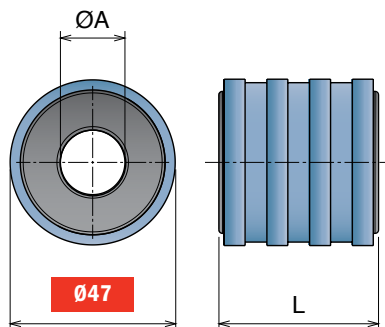

Part	Article-Nr.	L	ØA
220	22051	41	16
220	22052	41	18
220	22053	41	20

Material:  
Polyethylene (PE)  
Rubber: TPR



**Watertight**

## Locking collars

Max recommended tightening torque: 0,3 N mt

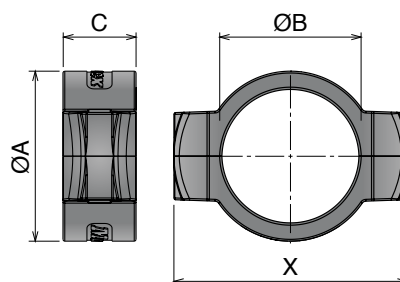

Part	Article-Nr.	ØA	ØB	C	X
215	21509	24	16	12	37
215	21503	26	18	14	40
215	21504	28	20	14	40

Material:

Clamps: Polyamide  
Screws and nuts: Stainless steel

## Flange bearings

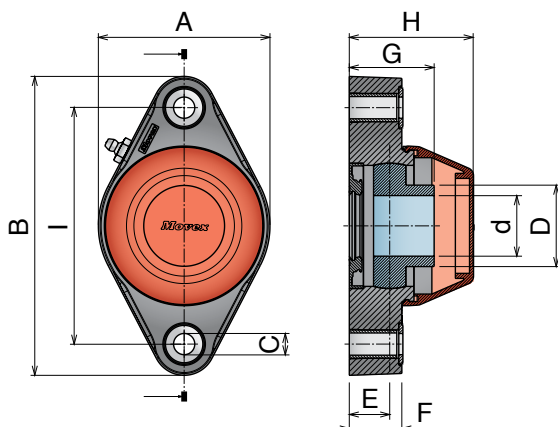

Part	Art-close	Series	d	I	A	B	C	D	E	F	G
826	82622	UCFL 206/90	30	90	85	116	10,2	44,5	14,5	20	42,2
Part	Art-close	Series	d	I	A	B	C	D	E	F	G
827	82722	UCFL 206/90	30	90	85	116	10,2	44,5	14,5	20	42,2

## Profiles

Below suggested wear strips to be used for respectively external side, internal side and belt support.

### Bar cap 5 mm

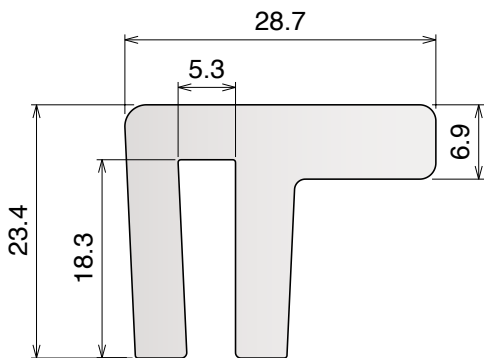
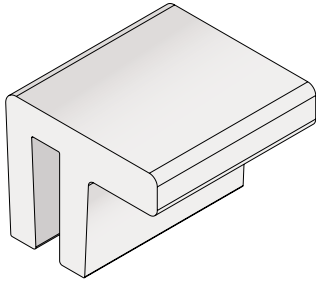

Part	Article-Nr.	L	Availability
1008	100803B	6 m	On request

**Material:** Polyethylene UHMW-PE with molecular density 5,600,000 g/mol  
 Linear expansion coefficient:  $1.1 \times 10^{-4} \text{ } ^\circ\text{F}^{-1}$  ( $2 \times 10^{-4} \text{ } ^\circ\text{C}^{-1}$ )  
 Operating temperature: -40 to 176°F (-40 to +80°C)

Fit on 5 mm

### Machined flat wear strip

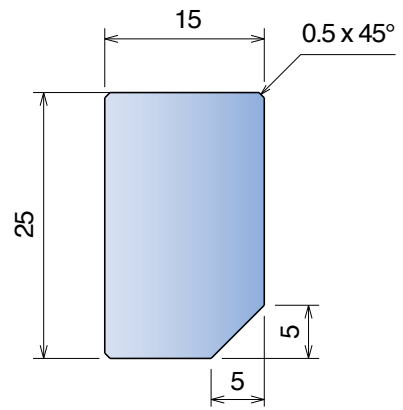
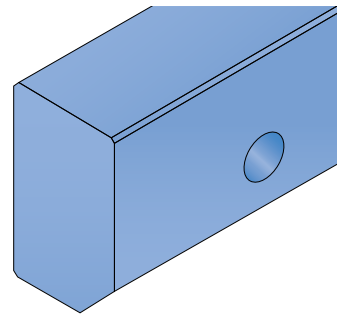

Part	Article-Nr.	L	Availability
700	700100G0	3 m	On request

**Material:** Polyethylene UHMW-PE with molecular density 9,200,000 g/mol.

**BluLub**, new material with reduced coefficient of friction and higher wear resistance. BluLub complies with the code of Federal Regulations of FDA.

Linear expansion coefficient:  $1.1 \times 10^{-4} \text{ } ^\circ\text{F}^{-1}$  ( $2 \times 10^{-4} \text{ } ^\circ\text{C}^{-1}$ )  
 Operating temperature: -40 to 176°F (-40 to +80°C)

### Bar cap 5 mm

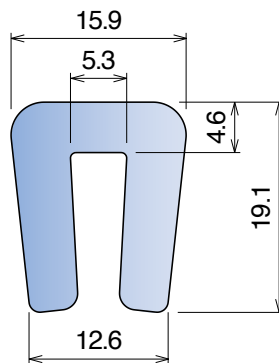
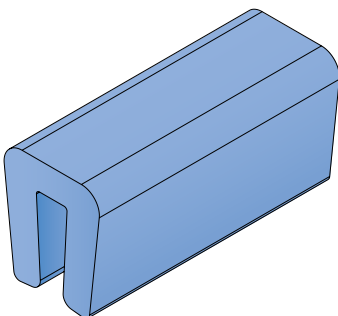

Part	Article-Nr.	L	Availability
153	15300C	3 m	On request

**Material:** Polyethylene UHMW-PE with molecular density 9,200,000 g/mol.

**BluLub**, new material with reduced coefficient of friction and higher wear resistance. BluLub complies with the code of Federal Regulations of FDA.

Linear expansion coefficient:  $1.1 \times 10^{-4} \text{ } ^\circ\text{F}^{-1}$  ( $2 \times 10^{-4} \text{ } ^\circ\text{C}^{-1}$ )  
 Operating temperature: -40 to 176°F (-40 to +80°C)

## Leveling feet

**Ø105**

DIAMETER (mm)



FIXING POINT

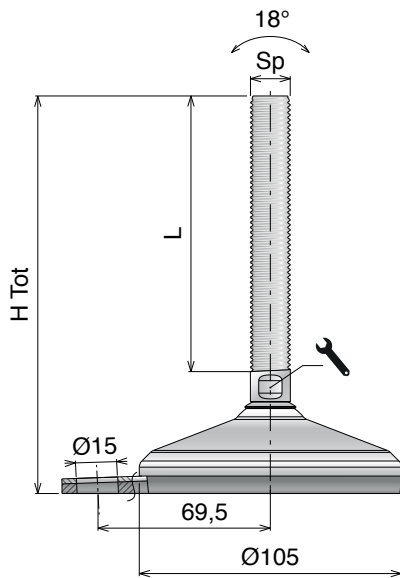

**Ø110**

DIAMETER (mm)



FIXING POINT

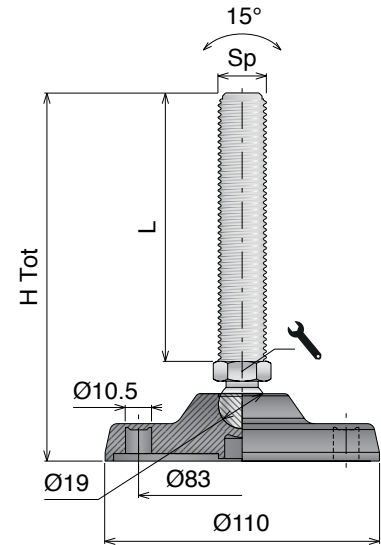

Article-Nr.	Sp	H Tot (mm)	L (mm)	Wrench (mm)	Load (N)
901317	M20	240	192,3	17	25.000

More leveling feet can be found on Movex general catalogue.

Article-Nr.	Article-Nr.	Sp	H Tot (mm)	L (mm)	Wrench (mm)	Load (N)
SS	FeZn				17	
94401H	94401ZH	M20	155	115	20	15.000

## Transfer modules

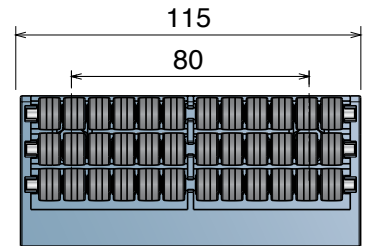
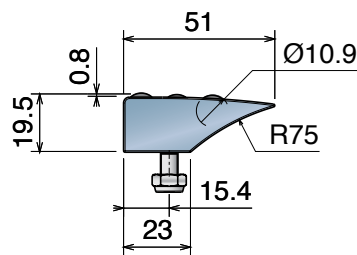
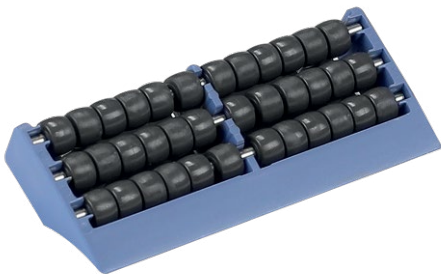

Part	Article-Nr.	Type
371	37102	B

**Material:** Module and rollers: Acetal resin / Pins, screws and nuts: Stainless steel

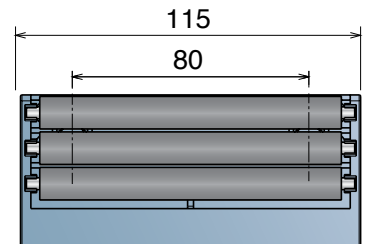
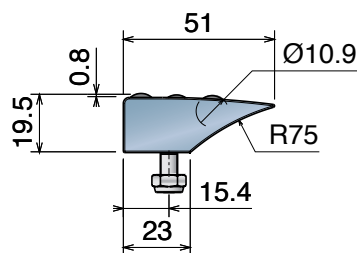
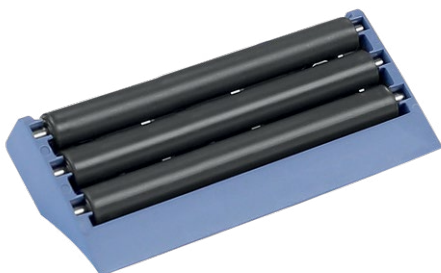

Part	Article-Nr.	Type
369	36902	B

**Material:** Module and rollers: Acetal resin / Pins, screws and nuts: Stainless steel



## Transfer modules

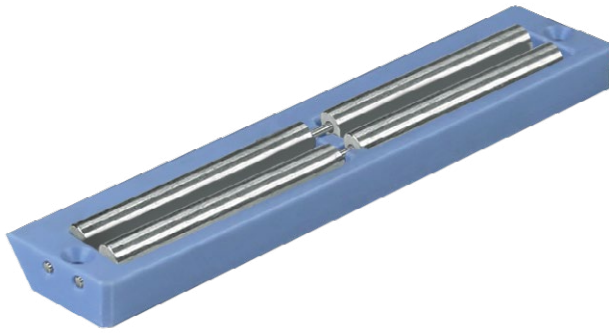

Part	Article-Nr.	Type	Material
342	34201	A	BluLub
342	34201N	B	BluLub
342	34201NL	C	BluLub
342	34201S	A	PE Black
342	34201NS	B	PE Black
342	34201NLS	C	PE Black

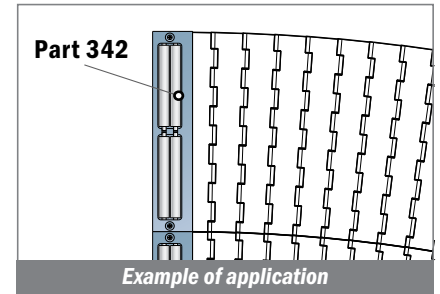

**Smart roller**  
with mini bearings  
in stainless steel

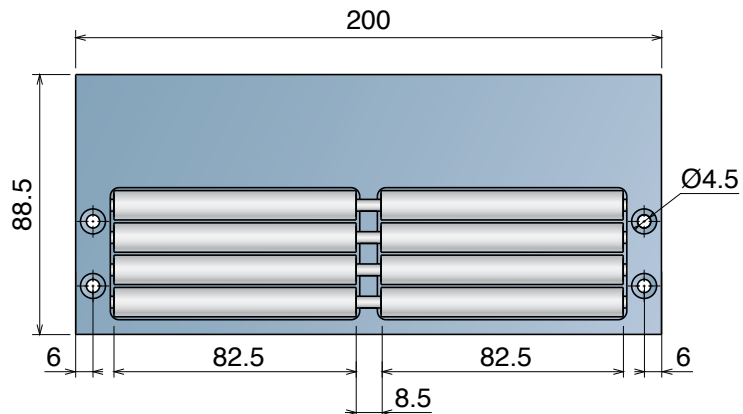
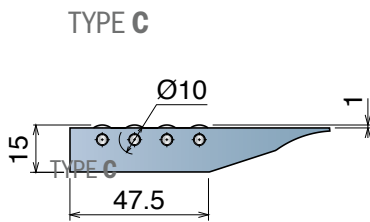
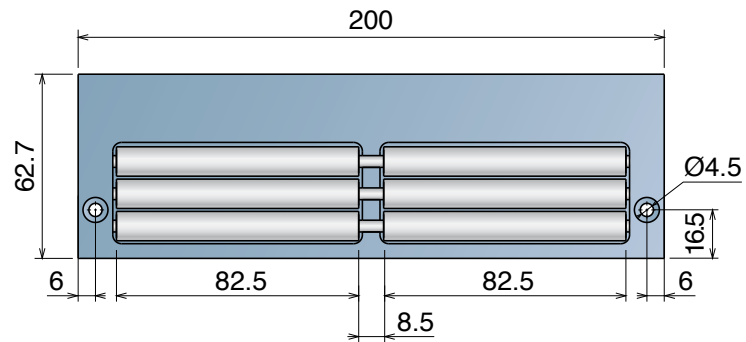
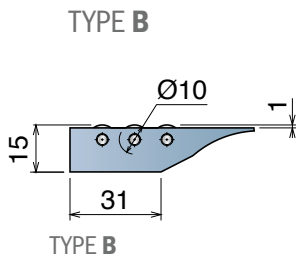
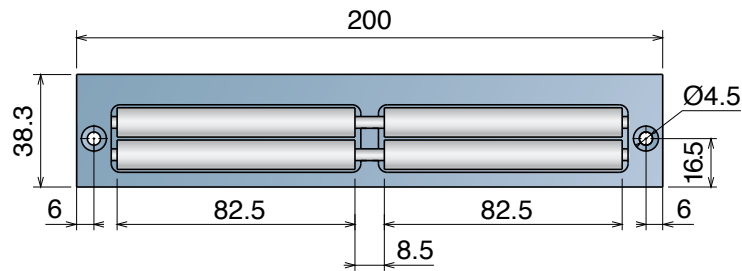
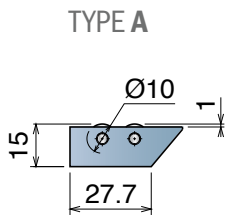

**Material:**  
Polyethylene  
UHMW-PE

## Machined internal profile

### ZEROCONTACT *Machined internal profile 90°*

Belt Width	200 mm	400 mm	600 mm	800 mm
Ri 600mm	700100GO-S-600-90	700100GO-S-600-90	700100GO-S-600-90	700100GO-S-600-90
Ri 800mm	700100GO-S-800-90	700100GO-S-800-90	700100GO-S-800-90	700100GO-S-800-90
Ri 1000mm	700100GO-S-800-90	700100GO-S-1000-90	700100GO-S-1000-90	700100GO-S-1000-90L
Ri 1200mm	700100GO-S-1200-90	700100GO-S-1200-90	700100GO-S-1200-90L	700100GO-S-1200-90L
Ri 1400mm	700100GO-S-1400-90	700100GO-S-1400-90	700100GO-S-1400-90	700100GO-S-1400-90
Ri 1600mm	700100GO-S-1600-90	700100GO-S-1600-90	700100GO-S-1600-90	-
Ri1800mm	700100GO-S-1800-90	700100GO-S-1800-90	-	-
Ri 2000mm	700100GO-S-2000-90	-	-	-

Belt Width	1000 mm	1200 mm	1400 mm	1600 mm
Ri 600mm	700100GO-S-600-90	700100GO-S-600-90L	700100GO-S-600-90L	700100GO-S-600-90L
Ri 800mm	700100GO-S-800-90L	700100GO-S-800-90L	700100GO-S-800-90L	-
Ri 1000mm	700100GO-S-1000-90L	700100GO-S-1000-90L	-	-
Ri 1200mm	700100GO-S-1200-90L	-	-	-
Ri 1400mm	-	-	-	-
Ri 1600mm	-	-	-	-
Ri1800mm	-	-	-	-
Ri 2000mm	-	-	-	-

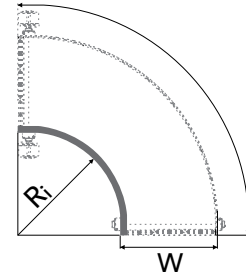

Machined internal profile available, on request, also in **BluLub®**

### ZEROCONTACT *Machined internal profile 90°*

Belt Width	200 mm	400 mm	600 mm	800 mm
Ri 600mm	700100GO-S-600-180	700100GO-S-600-180	700100GO-S-600-180	700100GO-S-600-180
Ri 800mm	700100GO-S-800-180	700100GO-S-800-180	700100GO-S-800-180	700100GO-S-800-180
Ri 1000mm	700100GO-S-1000-180	700100GO-S-1000-180	700100GO-S-1000-180	700100GO-S-1000-180L
Ri 1200mm	700100GO-S-1200-180	700100GO-S-1200-180	700100GO-S-1200-180L	700100GO-S-1200-180L
Ri 1400mm	700100GO-S-1400-180	700100GO-S-1400-180	700100GO-S-1400-180	700100GO-S-1400-180
Ri 1600mm	700100GO-S-1600-180	700100GO-S-1600-180	700100GO-S-1600-180	-
Ri1800mm	700100GO-S-1800-180	700100GO-S-1800-180	-	-
Ri 2000mm	700100GO-S-2000-180	-	-	-

Belt Width	1000 mm	1200 mm	1400 mm	1600 mm
Ri. 600mm	700100GO-S-600-180	700100GO-S-600-180L	700100GO-S-600-180L	700100GO-S-600-180L
Ri. 800mm	700100GO-S-800-180L	700100GO-S-800-180L	700100GO-S-800-180L	-
Ri. 1000mm	700100GO-S-1000-180L	700100GO-S-1000-180L	-	-
Ri. 1200mm	700100GO-S-1200-180L	-	-	-
Ri. 1400mm	-	-	-	-
Ri. 1600mm	-	-	-	-
Ri.1800mm	-	-	-	-
Ri. 2000mm	-	-	-	-

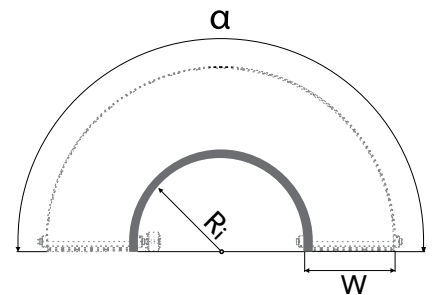

Machined internal profile available, on request, also in **BluLub®**

## Machined internal profiles

### ZEROPRO CONTACT Machined internal profiles 90°

Belt Width	249 mm	269 mm	419 mm	439 mm
Ri. 586mm	-	-	-	<b>700100GO-S-586-90</b>
Ri. 756mm	-	<b>700100GO-S-756-90</b>	-	<b>700100GO-S-756-90</b>
Ri. 1011mm	-	<b>700100GO-S-1011-90</b>	-	<b>700100GO-S-1011-90L</b>
Ri. 1031mm	<b>700100GO-S-1031-90</b>	-	<b>700100GO-S-1031-90L</b>	-
Ri. 1116mm	-	-	-	-
Ri. 1201mm	-	-	<b>700100GO-S-1201-90</b>	-
Ri. 1286mm	<b>700100GO-S-1286-90</b>	-	-	-
Ri. 1456mm	-	-	<b>700100GO-S-1456-90</b>	-
Ri. 1541mm	-	-	-	-

Belt Width	504mm	524 mm	864 mm	1034 mm
Ri. 586mm	-	<b>700100GO-S-586-90L</b>	<b>700100GO-S-586-90L</b>	<b>700100GO-S-586-90L</b>
Ri. 756mm	-	<b>700100GO-S-756-90L</b>	<b>700100GO-S-756-90L</b>	<b>700100GO-S-756-90L</b>
Ri. 1011mm	-	<b>700100GO-S-1011-90L</b>	<b>700100GO-S-1011-90L</b>	<b>700100GO-S-1011-90L</b>
Ri. 1031mm	-	-	-	-
Ri. 1116mm	<b>700100GO-S-1116-90</b>	-	-	-
Ri. 1201mm	-	-	-	-
Ri. 1286mm	<b>700100GO-S-1286-90</b>	-	-	-
Ri. 1456mm	-	-	-	-
Ri. 1541mm	<b>700100GO-S-1541-90</b>	-	-	-

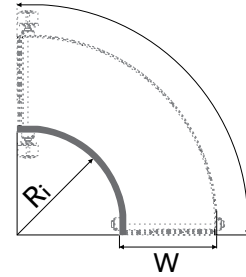

Machined internal profile available, on request, also in **BluLub®**

### ZEROPRO CONTACT Machined internal profiles 180°

Belt Width	249 mm	269 mm	419 mm	439 mm
Ri. 586mm	-	-	-	<b>700100GO-S-586-180</b>
Ri. 756mm	-	<b>700100GO-S-756-180</b>	-	<b>700100GO-S-756-180</b>
Ri. 1011mm	-	<b>700100GO-S-1011-180</b>	-	<b>700100GO-S-1011-180L</b>
Ri. 1031mm	<b>700100GO-S-586-180</b>	-	<b>700100GO-S-1031-180L</b>	-
Ri. 1116mm	-	-	-	-
Ri. 1201mm	-	-	<b>700100GO-S-1201-180</b>	-
Ri. 1286mm	<b>700100GO-S-1286-180</b>	-	-	-
Ri. 1456mm	-	-	<b>700100GO-S-1456-180</b>	-
Ri. 1541mm	-	-	-	-

Belt Width	504mm	524 mm	864 mm	1034 mm
Ri. 586mm	-	<b>700100GO-S-586-180L</b>	<b>700100GO-S-586-180L</b>	<b>700100GO-S-586-180L</b>
Ri. 756mm	-	<b>700100GO-S-756-180L</b>	<b>700100GO-S-756-180L</b>	<b>700100GO-S-756-180L</b>
Ri. 1011mm	-	<b>700100GO-S-1011-180L</b>	<b>700100GO-S-1011-180L</b>	<b>700100GO-S-1011-180L</b>
Ri. 1031mm	-	-	-	-
Ri. 1116mm	<b>700100GO-S-1116-180</b>	-	-	-
Ri. 1201mm	-	-	-	-
Ri. 1286mm	<b>700100GO-S-1286-180</b>	-	-	-
Ri. 1456mm	-	-	-	-
Ri. 1541mm	<b>700100GO-S-1541-180</b>	-	-	-

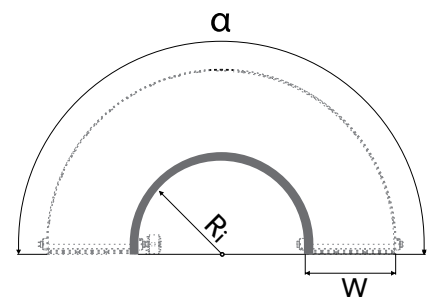

Machined internal profile available, on request, also in **BluLub®**

## Sliding machined curves

### ZEROCONTACT *Sliding machined curves 90°*

Belt Width	200 mm	400 mm	600 mm	800 mm
Ri 600mm	W02R06G090G1	W04R06G090G1	W06R06G090G1	W08R06G090G1
Ri 800mm	W02R08G090G1	W04R08G090G1	W06R08G090G1	W08R08G090G1
Ri 1000mm	W02R10G090G1	W04R10G090G1	W06R10G090G1	W08R10G090G1
Ri 1200mm	W02R12G090G1	W04R12G090G1	W06R12G090G1	W08R12G090G1
Ri 1400mm	W02R14G090G1	W04R14G090G1	W06R14G090G1	W08R14G090G1
Ri 1600mm	W02R16G090G1	W04R16G090G1	W06R16G090G1	-
Ri1800mm	W02R18G090G1	W04R18G090G1	-	-
Ri 2000mm	W02R20G090G1	-	-	-

Belt Width	1000 mm	1200 mm	1400 mm	1600 mm
Ri 600mm	W10R06G090G1	W12R06G090G1	W14R06G090G1	W16R06G090G1
Ri 800mm	W10R08G090G1	W12R08G090G1	W14R08G090G1	-
Ri 1000mm	W10R10G090G1	W12R10G090G1	-	-
Ri 1200mm	W10R12G090G1	-	-	-
Ri 1400mm	-	-	-	-
Ri 1600mm	-	-	-	-
Ri1800mm	-	-	-	-
Ri 2000mm	-	-	-	-

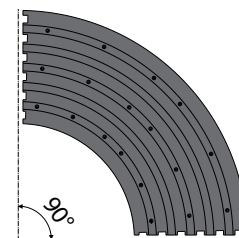

Machined curves available, on request, also in **BluLub®**

### ZEROCONTACT *Sliding machined curves 180°*

Belt Width	200 mm	400 mm	600 mm	800 mm
Ri 600mm	W02R06G180G1	W02R08G180G1	W02R10G180G1	W02R12G180G1
Ri 800mm	W04R06G180G1	W04R08G180G1	W04R10G180G1	W04R12G180G1
Ri 1000mm	W06R06G180G1	W06R08G180G1	W06R10G180G1	W06R12G180G1
Ri 1200mm	W08R06G180G1	W08R08G180G1	W08R10G180G1	W08R12G180G1
Ri 1400mm	W10R06G180G1	W10R08G180G1	W10R10G180G1	W10R12G180G1
Ri 1600mm	W12R06G180G1	W12R08G180G1	W12R10G180G1	-
Ri1800mm	W14R06G180G1	W14R08G180G1	-	-
Ri 2000mm	W16R06G180G1	-	-	-

Belt Width	1000 mm	1200 mm	1400 mm	1600 mm
Ri. 600mm	W02R14G180G1	W02R16G180G1	W02R18G180G1	W02R20G180G1
Ri. 800mm	W04R14G180G1	W04R16G 180G1	W04R18G180G1	-
Ri. 1000mm	W06R14G180G1	W06R16G180G1	-	-
Ri. 1200mm	W08R14G180G1	-	-	-
Ri. 1400mm	-	-	-	-
Ri. 1600mm	-	-	-	-
Ri.1800mm	-	-	-	-
Ri. 2000mm	-	-	-	-

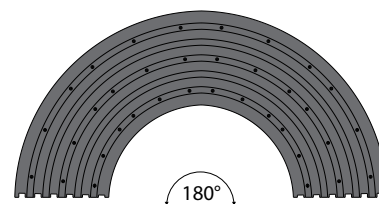

Machined curves available, on request, also in **BluLub®**

## Sliding machined curves

### ZEROPRO CONTACT Sliding machined curves 90°

Belt Width	249 mm	269 mm	419 mm	439 mm
Ri. 586mm	-	-	-	<b>W94R91G090G1</b>
Ri. 756mm	-	<b>W92R92G090G1</b>	-	<b>W94R92G090G1</b>
Ri. 1011mm	-	<b>W92R93G090G1</b>	-	<b>W94R93G090G1</b>
Ri. 1031mm	<b>W91R94G090G1</b>	-	<b>W93R94G090G1</b>	-
Ri. 1116mm	-	-	-	-
Ri. 1201mm	-	-	<b>W93R96G090G1</b>	-
Ri. 1286mm	<b>W91R97G090G1</b>	-	-	-
Ri. 1456mm	-	-	<b>W93R98G090G1</b>	-
Ri. 1541mm	-	-	-	-

Belt Width	504mm	524 mm	864 mm	1034 mm
Ri. 586mm	-	<b>W96R91G090G1</b>	<b>W97R91G090G1</b>	<b>W98R91G090G1</b>
Ri. 756mm	-	<b>W96R92G090G1</b>	<b>W97R92G090G1</b>	<b>W98R92G090G1</b>
Ri. 1011mm	-	<b>W96R93G090G1</b>	<b>W97R93G090G1</b>	<b>W98R93G090G1</b>
Ri. 1031mm	-	-	-	-
Ri. 1116mm	<b>W95R95G090G1</b>	-	-	-
Ri. 1201mm	-	-	-	-
Ri. 1286mm	<b>W95R97G090G1</b>	-	-	-
Ri. 1456mm	-	-	-	-
Ri. 1541mm	<b>W95R99G090G1</b>	-	-	-

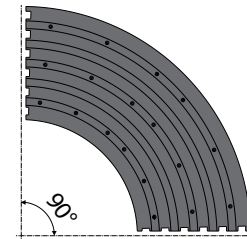

Machined curves available, on request, also in **BluLub®**

### ZEROPRO CONTACT Sliding machined curves 180°

Belt Width	249 mm	269 mm	419 mm	439 mm
Ri. 586mm	-	-	-	<b>W94R91G180G1</b>
Ri. 756mm	-	<b>W92R92G180G1</b>	-	<b>W94R92G180G1</b>
Ri. 1011mm	-	<b>W92R93G180G1</b>	-	<b>W94R93G180G1</b>
Ri. 1031mm	<b>W91R94G180G1</b>	-	<b>W93R94G180G1</b>	-
Ri. 1116mm	-	-	-	-
Ri. 1201mm	-	-	<b>W93R96G180G1</b>	-
Ri. 1286mm	<b>W91R97G180G1</b>	-	-	-
Ri. 1456mm	-	-	<b>W93R98G180G1</b>	-
Ri. 1541mm	-	-	-	-

Belt Width	504mm	524 mm	864 mm	1034 mm
Ri. 586mm	-	<b>W96R91G180G1</b>	<b>W97R91G180G1</b>	<b>W98R91G180G1</b>
Ri. 756mm	-	<b>W96R92G180G1</b>	<b>W97R92G180G1</b>	<b>W98R92G180G1</b>
Ri. 1011mm	-	<b>W96R93G180G1</b>	<b>W97R93G180G1</b>	<b>W98R93G180G1</b>
Ri. 1031mm	-	-	-	-
Ri. 1116mm	<b>W95R95G180G1</b>	-	-	-
Ri. 1201mm	-	-	-	-
Ri. 1286mm	<b>W95R97G180G1</b>	-	-	-
Ri. 1456mm	-	-	-	-
Ri. 1541mm	<b>W95R99G180G1</b>	-	-	-

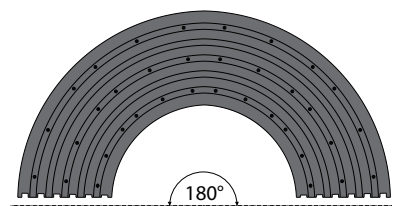

Machined curves available, on request, also in **BluLub®**

**Material:**  
Polyethylene  
UHMW-PE

## Two tracks sliding machined curves

### ZER<sup>PRO</sup>CONTACT Sliding machined curves 90°

Belt Width	524 mm	864 mm	1034 mm
Ri 586 mm	-	W97R91G090G2	W98R91G090G2
Ri 756mm	W96R92G090G2	W97R92G090G2	W98R92G090G2
Ri 1011mm	W96R93G090G2	W97R93G090G2	W98R93G090G2

Machined curves available, on request, also in **BluLub**<sup>®</sup>

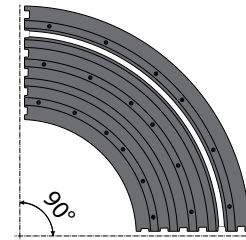

### ZER<sup>PRO</sup>CONTACT Sliding machined curves 180°

Belt Width	524 mm	864 mm	1034 mm
Ri 586 mm	-	W97R91G180G2	W98R91G180G2
Ri 756mm	W96R92G180G2	W97R92G180G2	W98R92G180G2
Ri 1011mm	W96R93G180G2	W97R93G180G2	W98R93G180G2

Machined curves available, on request, also in **BluLub**<sup>®</sup>

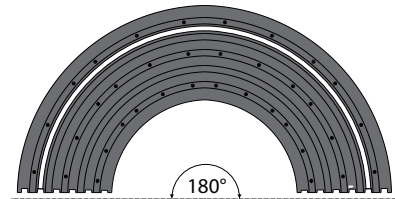

# ZEROCONTACT

CURVE CONVEYOR

Company	
Sales contact	
Contact	
Date	

Technical features	Please circle required input or fill the proper field							
Radius - mm (in)	600 (23.6)	800 (31.5)	1000 (39.4)	1200 (47.2)	1400 (55.1)	1600 (63)	1800 (70.9)	2000 (78.7)
Width - mm (in)	200 (7.9)	400 (15.7)	600 (23.6)	800 (31.5)	1000 (39.4)	1200 (47.2)	1400 (55.1)	1600 (63)
Angle	90°			180°			Different:	
Direction	Right (clockwise)				Left (counter clockwise)			
Gearmotor position	Internal				External			
Transfer plates	Plastic with stainless steel rollers				Stainless steel with stainless steel rollers			
Gearmotor *	No	Yes	SEW	Different shaft for:				
Floor supports height - mm (in)	No	Yes	1000+/-75 (39.4+/-3.0)	Different:				
ZeroATP - mm (in) **	No	Yes	Infeed	Outfeed		250 (9.8)	500 (19.7)	

\* For a different gearmotor, please fill with type and model, we will provide a quotation with the proper machined shaft.

\*\* In case of ZeroATP selected, standard transfers will not be included (based on sides selected).



ZeroATP Pro **	
No	Yes

Type of product	
Product dimensions (mm)	
Weight per linear meter (Kg/m)	
Belt Speed	
Number of tracks per products	

**Double check here if your combination Radius/Width is available**

W/R	600 (23.6)	800 (31.5)	1000 (39.4)	1200 (47.2)	1400 (55.1)	1600 (63)	1800 (70.9)	2000 (78.7)
200 (7.9)								
400 (15.7)								
600 (23.6)								
800 (31.5)								
1000 (39.4)								
1200 (47.2)								
1400 (55.1)								
1600 (63)								

**Example of module filled**



Technical features	Please circle required input or fill the proper field							
Radius - mm (inch)	600 (23.6)	800 (31.5)	1000 (39.4)	1200 (47.2)	1400 (55.1)	1600 (63)	1800 (70.9)	2000 (78.7)
Width - mm (inch)	200 (7.9)	400 (15.7)	600 (23.6)	800 (31.5)	1000 (39.4)	1200 (47.2)	1400 (55.1)	1600 (63)
Angle	90°			180°			Different:	
Direction	Right (clockwise)				Left (counter clockwise)			
Gearmotor position	Internal				External			
Transfer plates	Plastic with stainless steel rollers				No			
Painted steel frames	Blue Grey RAL 7031				Different (specify the RAL):			
Bottom safety cover	Yes				No			
Gearmotor *	No	Yes	BONFIGLIOLI	Different shaft for:				
Floor supports height - mm (inch)	No	Yes	1000+/-75 (39.4+/-3.0)	Different:				
ZeroATP - mm (inch) **	No	Yes	Infeed	Outfeed		250 (9.8)	500 (19.7)	

# ZERO CONTACT<sup>S</sup>

CURVE CONVEYOR

Company	
Sales contact	
Contact	
Date	

Technical features	Please circle required input or fill the proper field							
Radius - mm (in)	600 (23.6)	800 (31.5)	1000 (39.4)	1200 (47.2)	1400 (55.1)	1600 (63)	1800 (70.9)	2000 (78.7)
Width - mm (in)	200 (7.9)	400 (15.7)	600 (23.6)	800 (31.5)	1000 (39.4)	1200 (47.2)	1400 (55.1)	1600 (63)
Angle	90°			180°			Different:	
Direction	Right (clockwise)				Left (counter clockwise)			
Gearmotor position	Internal				External			
Transfer plates	Plastic with stainless steel rollers				No			
Painted steel frames	Blue Grey RAL 7031				Different (specify the RAL):			
Bottom safety cover	Yes				No			
Gearmotor *	No	Yes	BONFIGLIOLI	Different shaft for:				
Floor supports height - mm (in)	No	Yes	1000+/-75 (39.4+/-3.0)	Different:				
ZeroATP - mm (in) **	No	Yes	Infeed		Outfeed		250 (9.8)	500 (19.7)

\* In case of different gearmotor, please provide model and type name and we will quote a curve with required machined shaft.

\*\* In case of ZeroATP, standard transfers plates will not be included (based on the side selected).



**ZERO<sup>PRO</sup>ATP**  
ACTIVE TRANSFER PLATE

**ZeroATP Pro \*\***

No	Yes
----	-----

Type of product	
Product dimensions (mm)	
Weight per linear meter (Kg/m)	
Belt Speed	
Number of tracks per products	

**Double check here if your combination Radius/Width is available**

W/R	600 (23.6)	800 (31.5)	1000 (39.4)	1200 (47.2)	1400 (55.1)	1600 (63)	1800 (70.9)	2000 (78.7)
200 (7.9)								
400 (15.7)								
600 (23.6)								
800 (31.5)								
1000 (39.4)								
1200 (47.2)								
1400 (55.1)								
1600 (63)								

**Example of module filled**



Technical features	Please circle required input or fill the proper field							
Radius - mm (inch)	600 (23.6)	800 (31.5)	1000 (39.4)	1200 (47.2)	1400 (55.1)	1600 (63)	1800 (70.9)	2000 (78.7)
Width - mm (inch)	200 (7.9)	400 (15.7)	600 (23.6)	800 (31.5)	1000 (39.4)	1200 (47.2)	1400 (55.1)	1600 (63)
Angle	90°			180°			Different:	
Direction	Right (clockwise)				Left (counter clockwise)			
Gearmotor position	Internal				External			
Transfer plates	Plastic with stainless steel rollers				No			
Painted steel frames	Blue Grey RAL 7031				Different (specify the RAL):			
Bottom safety cover	Yes				No			
Gearmotor *	No	Yes	BONFIGLIOLI	Different shaft for:				
Floor supports height - mm (inch)	No	Yes	1000+/-75 (39.4+/-3.0)	Different:				
ZeroATP - mm (inch) **	No	Yes	Infeed		Outfeed		250 (9.8)	500 (19.7)





Company	
Sales contact	
Contact	
Date	

Technical features	Please circle required input or fill the proper field							
Radius - mm (in)	600 (23.6)	800 (31.5)	1000 (39.4)	1200 (47.2)	1400 (55.1)	1600 (63)	1800 (70.9)	2000 (78.7)
Width - mm (in)	200 (7.9)	400 (15.7)	600 (23.6)	800 (31.5)	1000 (39.4)	1200 (47.2)	1400 (55.1)	1600 (63)
Angle	90°			180°			Different:	
Drive	Bi-Directional							
Gearmotor position	Central							
Transfer plates	Plastic with stainless steel rollers				Stainless steel with stainless steel rollers			
Gearmotor *	No	Yes	SEW	Different shaft for:				
Floor supports height - mm (in)	No	Yes	1000+/-75 (39.4+/-3.0)	Different:				
ZeroATP - mm (in) **	No	Yes	Infeed	Outfeed		250 (9.8)	500 (19.7)	

\* For a different gearmotor, please fill with type and model, we will provide a quotation with the proper machined shaft.  
 \*\* In case of ZeroATP selected, standard transfers will not be included (based on sides selected).  
 \*\*\* In case of painted version please specify in your request.



ZeroATP Pro **	
No	Yes

Type of product	
Product dimensions (mm)	
Weight per linear meter (Kg/m)	
Belt Speed	
Number of tracks per products	

**Double check here if your combination Radius/Width is available**

W/R	600 (23.6)	800 (31.5)	1000 (39.4)	1200 (47.2)	1400 (55.1)	1600 (63)	1800 (70.9)	2000 (78.7)
200 (7.9)								
400 (15.7)								
600 (23.6)								
800 (31.5)								
1000 (39.4)								
1200 (47.2)								
1400 (55.1)								
1600 (63)								

**Example of module filled**



Technical features	Please circle required input or fill the proper field							
Radius - mm (inch)	600 (23.6)	800 (31.5)	1000 (39.4)	1200 (47.2)	1400 (55.1)	1600 (63)	1800 (70.9)	2000 (78.7)
Width - mm (inch)	200 (7.9)	400 (15.7)	600 (23.6)	800 (31.5)	1000 (39.4)	1200 (47.2)	1400 (55.1)	1600 (63)
Angle	90°			180°			Different:	
Drive	Central							
Gearmotor position	External							
Transfer plates	Plastic with stainless steel rollers				Stainless steel with stainless steel rollers			
Painted steel frames	Blue Grey RAL 7031				Different (specify the RAL):			
Bottom safety cover	Yes				No			
Gearmotor *	No	Yes	SEW	Different shaft for:				
Floor supports height - mm (inch)	No	Yes	1000+/-75 (39.4+/-3.0)	Different:				
ZeroATP - mm (inch) **	No	Yes	Infeed	Outfeed		250 (9.8)	500 (19.7)	

# ZER<sup>520</sup>CONTACT<sup>H</sup>

CURVE CONVEYOR

Company	
Sales contact	
Contact	
Date	

Technical features	Please circle required input or fill the proper field							
Radius - mm (in)	600 (23.6)	800 (31.5)	1000 (39.4)	1200 (47.2)	1400 (55.1)	1600 (63)	1800 (70.9)	2000 (78.7)
Width - mm (in)	200 (7.9)	400 (15.7)	600 (23.6)	800 (31.5)	1000 (39.4)	1200 (47.2)	1400 (55.1)	1600 (63)
Angle	90°			180°			Different:	
Direction	Right (clockwise)				Left (counter clockwise)			
Gearmotor position	Internal				External			
Transfer plates	No	Plastic with stainless steel rollers			Stainless steel with stainless steel rollers			
Gearmotor *	No	Yes	SEW	Different shaft for:				
Floor supports height - mm (in)	No	Yes	1000+/-75 (39.4+/-3.0)	Different:				
ZeroATP - mm (in) **	No	Yes	Infeed	Outfeed		250 (9.8)	500 (19.7)	

\* For a different gearmotor, please fill with type and model, we will provide a quotation with the proper machined shaft.

\*\* In case of ZeroATP selected, standard transfers will not be included (based on sides selected).



**ZERO<sup>PRO</sup>ATP**  
ACTIVE TRANSFER PLATE

ZeroATP Pro **	
No	Yes

Type of product	
Product dimensions (mm)	
Weight per linear meter (Kg/m)	
Belt Speed	
Number of tracks per products	

**Double check here if your combination Radius/Width is available**

W/R	600 (23.6)	800 (31.5)	1000 (39.4)	1200 (47.2)	1400 (55.1)	1600 (63)	1800 (70.9)	2000 (78.7)
200 (7.9)								
400 (15.7)								
600 (23.6)								
800 (31.5)								
1000 (39.4)								
1200 (47.2)								
1400 (55.1)								
1600 (63)								

**Example of module filled**

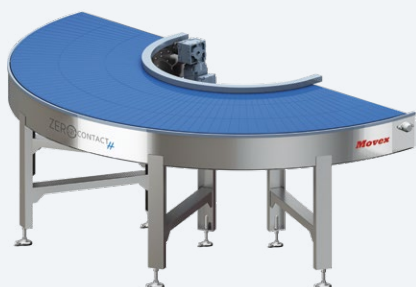

Technical features	Please circle required input or fill the proper field							
Radius - mm (inch)	600 (23.6)	800 (31.5)	1000 (39.4)	1200 (47.2)	1400 (55.1)	1600 (63)	1800 (70.9)	2000 (78.7)
Width - mm (inch)	200 (7.9)	400 (15.7)	600 (23.6)	800 (31.5)	1000 (39.4)	1200 (47.2)	1400 (55.1)	1600 (63)
Angle	90°			180°			Different:	
Direction	Right (clockwise)				Left (counter clockwise)			
Gearmotor position	Internal				External			
Transfer plates	No	Plastic with stainless steel rollers			Stainless steel with stainless steel rollers			
Painted steel frames	Blue Grey RAL 7031						Different (specify the RAL):	
Bottom safety cover	Yes						No	
Gearmotor *	No	Yes	SEW	Different shaft for:				
Floor supports height - mm (inch)	No	Yes	1000+/-75 (39.4+/-3.0)	Different:				
ZeroATP - mm (inch) **	No	Yes	Infeed	Outfeed		250 (9.8)	500 (19.7)	

# ZERO<sup>PRO</sup>CONTACT

CURVE CONVEYOR

Company	
Sales contact	
Contact	
Date	

Technical features	Please circle required input or fill the proper field									
Radius - mm (in)	586 (23.1)	756 (29.8)	1011 (39.8)	1031 (40.6)	1116 (43.9)	1201 (47.3)	1286 (50.6)	1456 (57.3)	1541 (60.7)	
Width - mm (in)	249 (9.8)	269 (10.6)	419 (16.5)	439 (17.3)	504 (19.8)	524 (20.6)	864 (34)	1034 (40.7)		
Angle	90°			180°			Different:			
Direction	Right (clockwise)					Left (counter clockwise)				
Version *	Standard					"Two-Tracks"				
Gearmotor position	Internal					External				
Transfer plates	Plastic with stainless steel rollers					Stainless steel with stainless steel rollers				
Gearmotor **	No	Yes	SEW	Different shaft for:						
Floor supports height - mm (in)	No	Yes	1000+/-75 (39.4+/-3.0)	Different:						
ZeroATP - mm (in) ***	No	Yes	Infeed	Outfeed		250 (9.8)	500 (19.7)			

\* In case of "Two-Tracks" version, no need to fill Gearmotor position fields.  
 \*\* In case of different gearmotor, please provide model and type name and we will quote a curve with required machined shaft.  
 \*\*\* In case of ZeroATP, standard transfers plates will not be included (based on the side selected).



ZeroATP Pro ***	
No	Yes

Type of product	
Product dimensions (mm)	
Weight per linear meter (Kg/m)	
Belt Speed	
Number of tracks per products	

**Double check here if your combination Radius/Width is available**

W/R	586 (23.1)	756 (29.8)	1011 (39.8)	1031 (40.6)	1116 (43.9)	1201 (47.3)	1286 (50.6)	1456 (57.3)	1541 (60.7)
249 (9.8)									
269 (10.6)									
419 (16.5)									
439 (17.3)									
504 (19.8)									
524 (20.6)									
864 (34)									
1034 (40.7)									

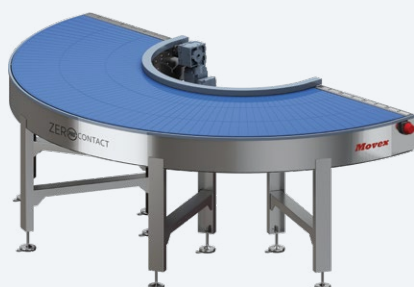

**Example of module filled**

Technical features	Please circle required input or fill the proper field									
Radius - mm (inch)	600 (23.6)	800 (31.5)	1000 (39.4)	1200 (47.2)	1400 (55.1)	1600 (63)	1800 (70.9)	2000 (78.7)		
Width - mm (inch)	200 (7.9)	400 (15.7)	600 (23.6)	800 (31.5)	1000 (39.4)	1200 (47.2)	1400 (55.1)	1600 (63)		
Angle	90°			180°			Different:			
Direction	Right (clockwise)					Left (counter clockwise)				
Gearmotor position	Internal					External				
Transfer plates	Plastic with stainless steel rollers					No				
Painted steel frames	Blue Grey RAL 7031					Different (specify the RAL):				
Bottom safety cover	Yes					No				
Gearmotor *	No	Yes	BONFIGLIOLI	Different shaft for:						
Floor supports height - mm (inch)	No	Yes	1000+/-75 (39.4+/-3.0)	Different:						
ZeroATP - mm (inch) **	No	Yes	Infeed	Outfeed		250 (9.8)	500 (19.7)			

# General & Supply details

Buying the **Zero Contact™** curve you will get a reliable solution, able to improve your efficiency line. The main features of the **Zero Contact™** curve are:

- **Modular belt** made of plastic material with low coefficient of friction
- **Machined sprockets** for high-precision engagement
- **Bearings** at inside of curve for reduced friction
- **Return rollers** with rubber for belt support in return section reducing noise as well as wear
- **Stainless steel covers** for improved safety
- **Machined transfer modules** with stainless steel rollers support with stainless steel mini-bearings

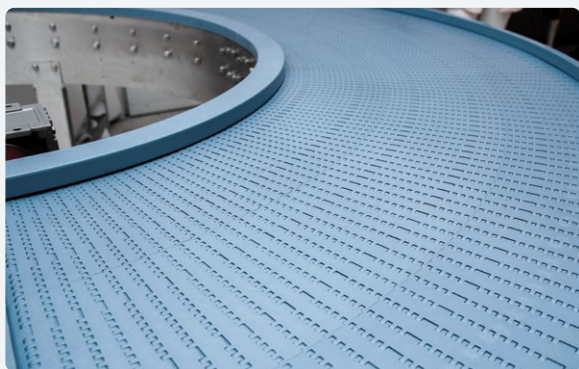

**Movex** ensures rigid quality control process for all the curves; all of them are assembled carefully by using only approved parts, so to guarantee perfect functionality. Every curve is tested at the provided speed and all the transfers are checked in planarity.

A Quality control technical data sheet is added for every delivery, as a double check by our Quality Control department.

To guarantee the integrity of the good receiving, **Movex** ships every **Zero Contact™** curve into wooden crate, free of charge and always included into the quotation you receive.

Movex always provides a Maintenance Manual, with all required information for:

- Features
- Operation and safety
- Installation
- Maintenance
- Cleaning
- Spare parts



For more information or specific requests please contact your sales representative or send an e-mail to [info@movexii.com](mailto:info@movexii.com) and check our dedicated engineering manual.

# ***Movex***<sup>®</sup>

This catalogue presents and includes the latest generations of products shown in earlier publications and it relates to the current production.

Other information, which may be different from that contained in this catalogue has to be considered invalid. **Movex<sup>®</sup> S.p.A.** reserves the right to carry out modifications rendered necessary by the technical evolution of the products.

© Copyright Movex<sup>®</sup> S.p.A. 2024

The contents of this catalogue are the copyright of **Movex<sup>®</sup> S.p.A.** and may not be reproduced

(even extracts) unless written permission is granted.

Every care has been taken to ensure the accuracy of the information contained in this publication but no liability can be accepted for any error or omissions.



movexii.com

# Movex<sup>®</sup>

## Movex worldwide

### Movex GmbH

P +49-6204-9375-0

### Movex Brasil Ltda

P +55-15-3141-2550

### Movex France

P +33 06-21-02-79-15

### Movex AG India

P +91-120-4159660-62

### Movex UK Ltd.

P +44-77-20678442

### Movex Nederland

P +31-630-994850

### Movex USA Inc.

P +1-877-401-5377

### Movex SA de CV

P +52-1-331845818

### Movex CIS countries

P +39-348-7769760

### Headquarter

Viale Industria, 22 - 24060  
Castelli Calepio (BG) Italy

### Logistics center

Via Repubblica, 21/E - 24060  
Castelli Calepio (BG) Italy