

Catalog
News

LFB Modular Belts

COMPLETE RANGE

RAL
5005

NEW PRODUCTS INCLUDED IN THE CATALOG.



Movex[®]
CATALOG NEWS





Movex's Blue
low friction acetal modular belts

RANGE EXTENSION

RAL 5005

LFB is a plastic material specifically developed for chains and belts in hygienic and food environments, ideal to run dry, guaranteeing high performances and efficiency.

Available for more than 20 different series, a growing number of companies are implementing **LFB** into their production lines, with excellent results.

Contact us and request a free quotation.

Modular belts available:

Other different types of product in LFB are on request.



510 FT

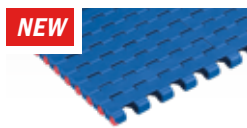

520 FT

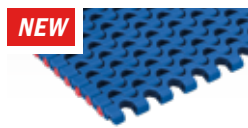

520 FG



525 HD FT

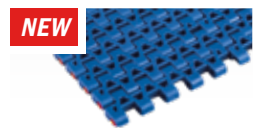

525 HD FG

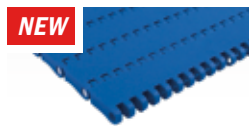

550 FT

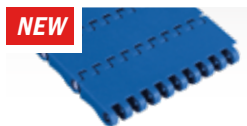

550 FT
One track belt

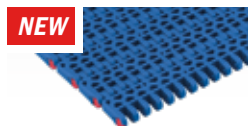

550 FG

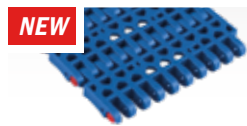

550 FG
One track belt

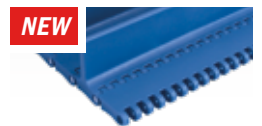

550 FLIGHT TOP

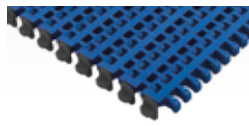

556 FT

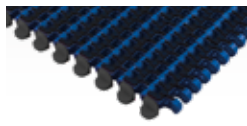

556 GT

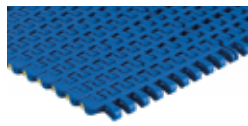

600 Standard

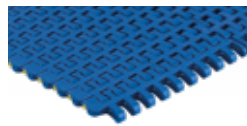

600 Heavy duty

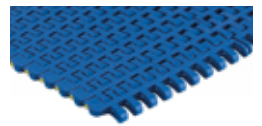

600 Heavy duty
with Bearings

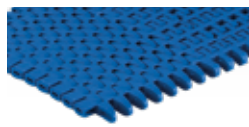

600 small radius

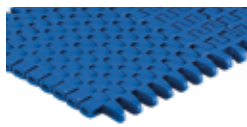

600 HD/SR

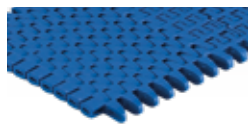

600 HD/SR
with Bearings

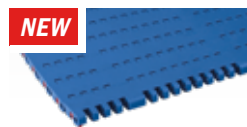

Zero Contact



260 M FT



260 M FG



260 TAB

Energy saving

Low friction

High efficiency

High visibility

FDA APPROVAL

510 FT

Tappeto Modulare 510 FT, H=6 M=3"
 Modular Belt Series 510 FT, H=6 M=3" / Modulare Mattenkette 510 FT, H=6 M=3"

PATENTED

CODE STRUCTURE GUIDE (Example)

Backflex radius min.: 7.5 mm

5331	23	0012	A
Series	*Material	Width	Version

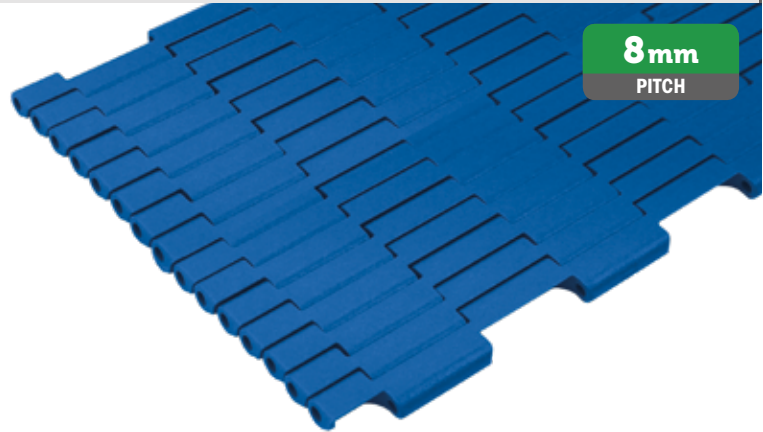

RAL 5005



- Easier installation
- Quicker maintenance

*Material

LFB - Code 23
 Low friction Acetal

Max w. load: 3000 N/m
 Weight: 5,8 kg/m²
 Temp. range dry: -40÷80 °C
 Temp. range wet: -40÷65 °C
 Pin material: PBT grey

Other Material available:

LFA - Code 01

MX - Code 03

Version A - Standard

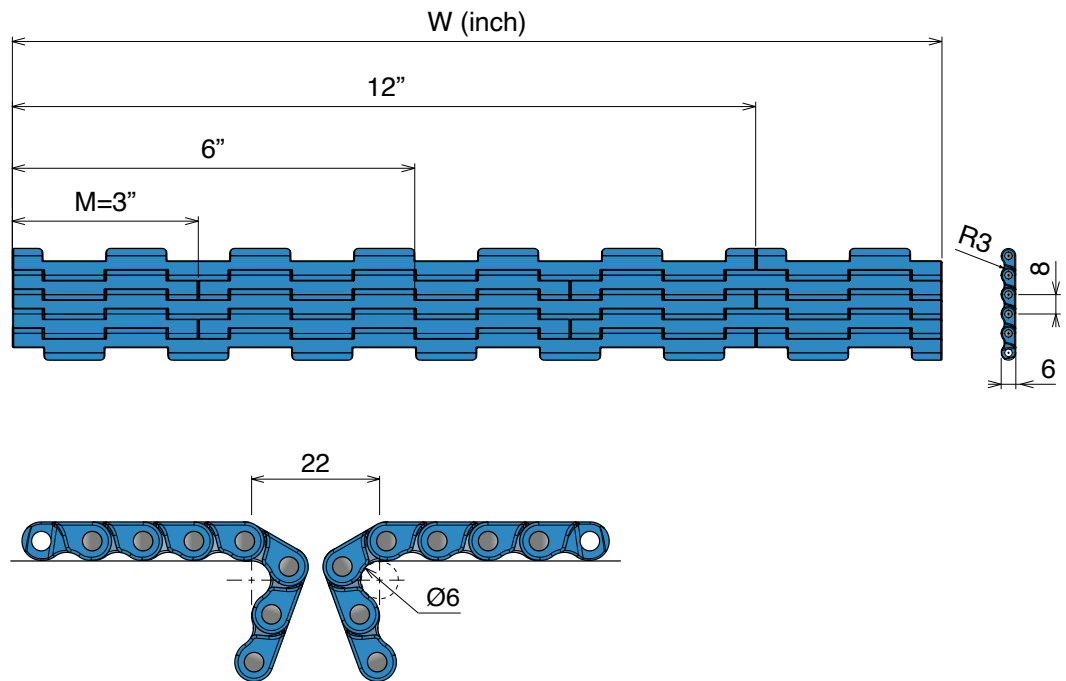

Version A - Standard

Series	Material	Width	Version
5331	*	0003	A
5331	*	0006	A
5331	*	0009	A
5331	*	0012	A
5331	*	0015	A
5331	*	0018	A
5331	*	0021	A
5331	*	0024	A
5331	*	0027	A
5331	*	0030	A
5331	*	0033	A
5331	*	0036	A
5331	*	0039	A
5331	*	0042	A
5331	*	0045	A
5331	*	0048	A

Belts wider than standard are available
 with 3 inch increments

520 FT

Tappeto Modulare 520 FT, H=8,7 M=85
 Modular Belt Series 520 FT, H=8,7 M=85 / Modulare Mattenkette 520 FT, H=8,7 M=85

CODE STRUCTURE GUIDE (Example)

Backflex radius min.: 10 mm

5201	01	0085	A
Series	*Material	Width	Version

RAL 5005

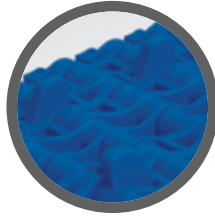

REINFORCED POSITIONER

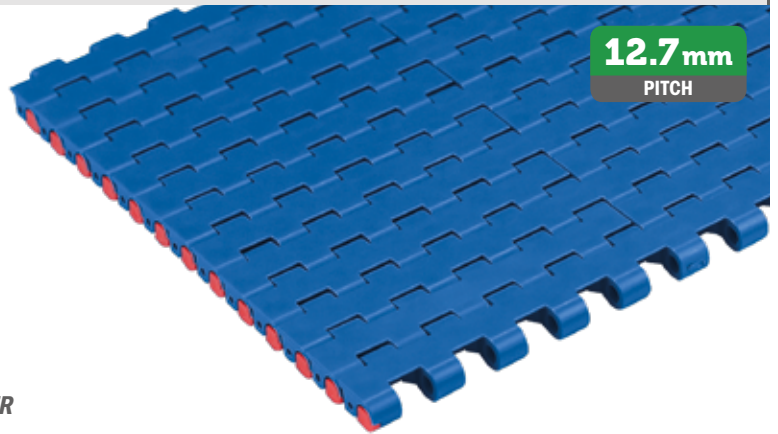

12.7 mm
PITCH

*Material

LFB - Code 23
Low friction Acetal

Max w. load: 21500 N/m
 Weight: 7,8 kg/m²
 Temp. range dry: -40+80 °C
 Temp. range wet: -40+65 °C
 Pin material: PBT white

Other Material available:

LFA - Code 01

PP - Code 02

MX - Code 03

MPX - Code 25

PFX - Code 30

Version A - Standard

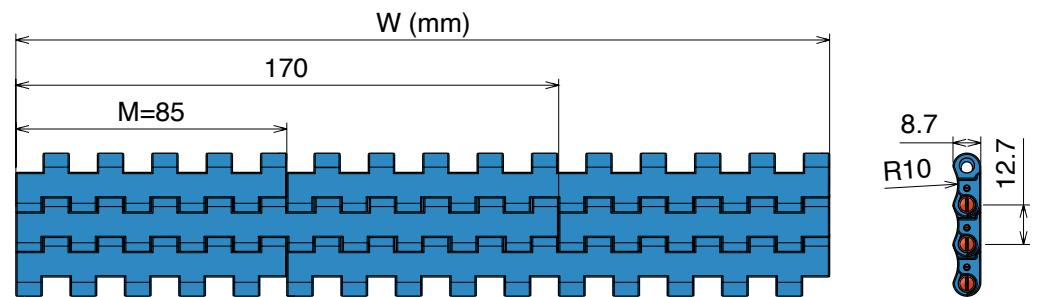

Version B - With 1 Positioner

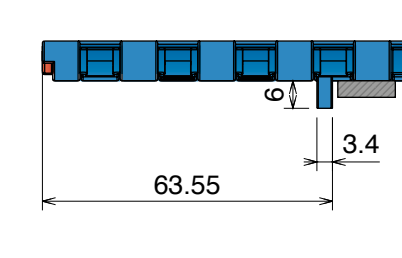

Version C - With 2 Positioners

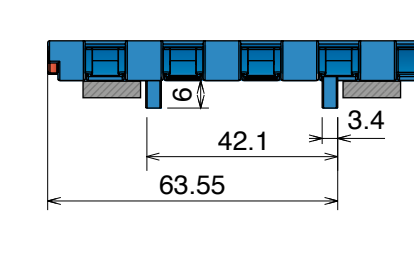

Version A - Standard

Series	Material	Width	Version
5201	*	0085	A
5201	*	0170	A
5201	*	0255	A
5201	*	0340	A
5201	*	0425	A
5201	*	0510	A
5201	*	0595	A
5201	*	0680	A
5201	*	0765	A
5201	*	0850	A
5201	*	0935	A
5201	*	1020	A
5201	*	1105	A
5201	*	1190	A
5201	*	1275	A
5201	*	1360	A
5201	*	1445	A
5201	*	1530	A

Version B - With 1 Positioner

Series	Material	Width	Version
5201	*	0085	B
5201	*	0170	B
5201	*	0255	B
5201	*	0340	B
5201	*	0425	B
5201	*	0510	B
5201	*	0595	B
5201	*	0680	B
5201	*	0765	B
5201	*	0850	B
5201	*	0935	B
5201	*	1020	B
5201	*	1105	B
5201	*	1190	B
5201	*	1275	B
5201	*	1360	B
5201	*	1445	B
5201	*	1530	B

Version C - With 2 Positioners

Series	Material	Width	Version
5201	*	0085	C
5201	*	0170	C
5201	*	0255	C
5201	*	0340	C
5201	*	0425	C
5201	*	0510	C
5201	*	0595	C
5201	*	0680	C
5201	*	0765	C
5201	*	0850	C
5201	*	0935	C
5201	*	1020	C
5201	*	1105	C
5201	*	1190	C
5201	*	1275	C
5201	*	1360	C
5201	*	1445	C
5201	*	1530	C

Belts wider than standard are available with 85 mm increments

520 FG Open Surface 25% Tappeto Modulare 520 FG, H=8,7 M=85 Modular Belt Series 520 FG, H=8,7 M=85 / Modulare Mattenkette 520 FG, H=8,7 M=85

CODE STRUCTURE GUIDE (Example)

Backflex radius min.: 10 mm

5202	01	0085	A
Series	*Material	Width	Version

12.7mm
PITCH

RAL 5005

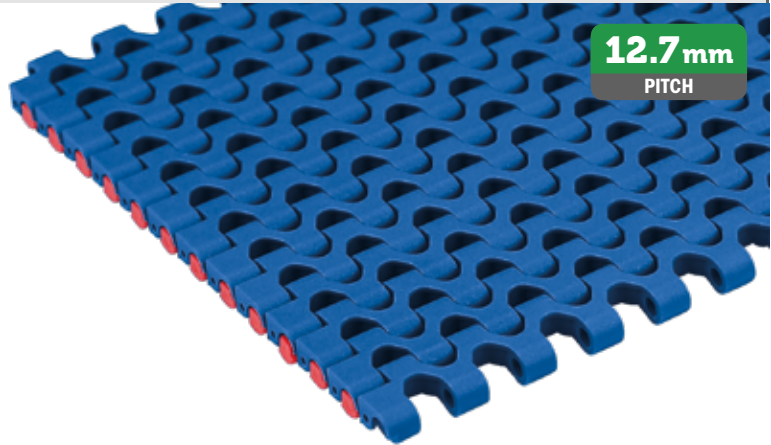
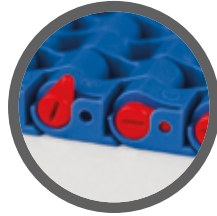

*Material

LFB - Code 23
Low friction Acetal

Max w. load: 21500 N/m
Weight: 7,5 kg/m²
Temp. range dry: -40÷80 °C
Temp. range wet: -40÷65 °C
Pin material: PBT white

Other Material available:

LFA - Code 01

PP - Code 02

MX - Code 03

DKM - Code 16

MWX - Code 17

MPX - Code 25

Version A - Standard

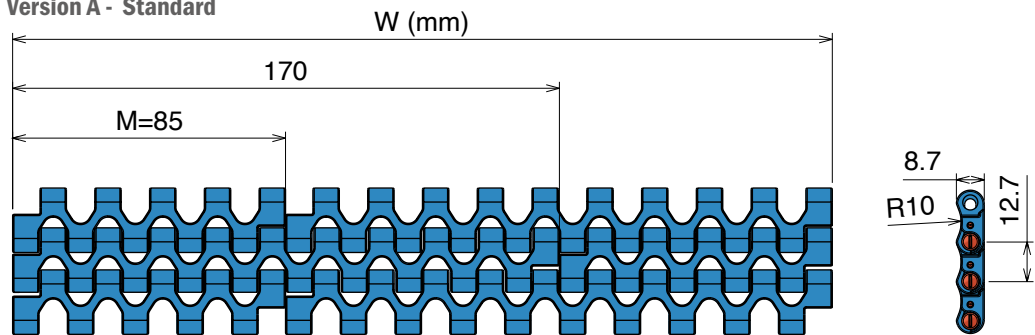

Version B - With 1 Positioner

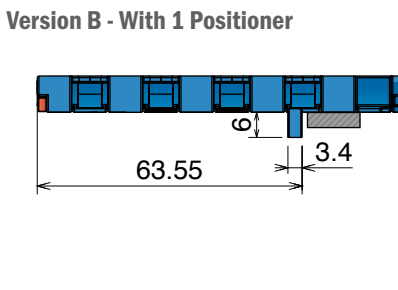

Version C - With 2 Positioners

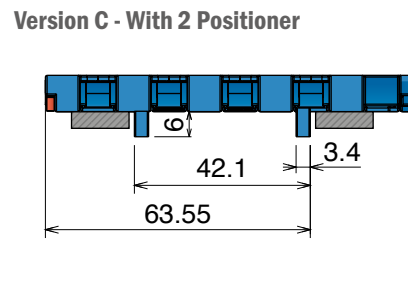

Version A - Standard

Series	Material	Width	Version
5202	*	0085	A
5202	*	0170	A
5202	*	0255	A
5202	*	0340	A
5202	*	0425	A
5202	*	0510	A
5202	*	0595	A
5202	*	0680	A
5202	*	0765	A
5202	*	0850	A
5202	*	0935	A
5202	*	1020	A
5202	*	1105	A
5202	*	1190	A
5202	*	1275	A
5202	*	1360	A
5202	*	1445	A
5202	*	1530	A

Version B - With 1 Positioner

Series	Material	Width	Version
5202	*	0085	B
5202	*	0170	B
5202	*	0255	B
5202	*	0340	B
5202	*	0425	B
5202	*	0510	B
5202	*	0595	B
5202	*	0680	B
5202	*	0765	B
5202	*	0850	B
5202	*	0935	B
5202	*	1020	B
5202	*	1105	B
5202	*	1190	B
5202	*	1275	B
5202	*	1360	B
5202	*	1445	B
5202	*	1530	B

Version C - With 2 Positioners

Series	Material	Width	Version
5202	*	0085	C
5202	*	0170	C
5202	*	0255	C
5202	*	0340	C
5202	*	0425	C
5202	*	0510	C
5202	*	0595	C
5202	*	0680	C
5202	*	0765	C
5202	*	0850	C
5202	*	0935	C
5202	*	1020	C
5202	*	1105	C
5202	*	1190	C
5202	*	1275	C
5202	*	1360	C
5202	*	1445	C
5202	*	1530	C

Belts wider than standard are available with 85 mm increments

525 HD FT

Tappeto Modulare 525 HD, H=8,7 M=85
 Modular Belt Series 525 HD, H=8,7 M=85 / Modulare Mattenkette 525 HD, H=8,7 M=85

CODE STRUCTURE GUIDE (Example)

Backflex radius min.: 25 mm

5261	01	0085	A
Series	*Material	Width	Version

15.0mm
PITCH

RAL 5005

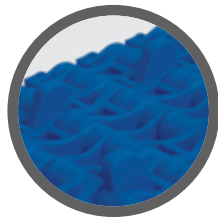

REINFORCED POSITIONER

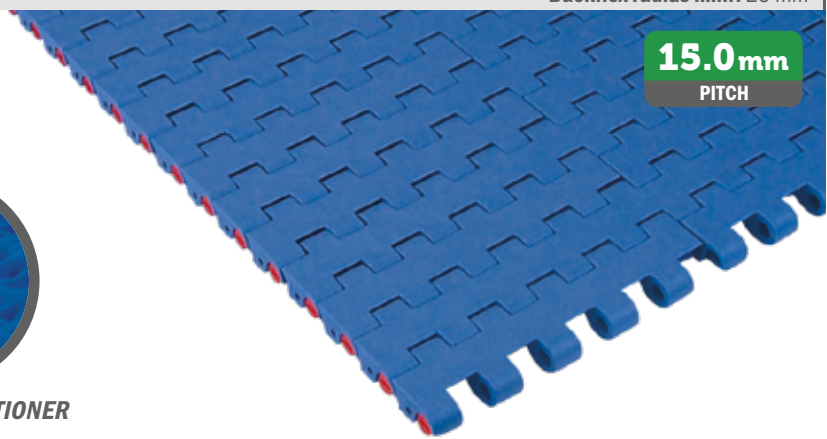

*Material

LFB - Code 23
Low friction Acetal

Max w. load: 25500 N/m
 Weight: 9,0 kg/m²
 Temp. range dry: -40÷80 °C
 Temp. range wet: -40÷65 °C
 Pin material: PBT white

Other Material available:

LFA - Code 01

PP - Code 02

MX - Code 03

PFX - Code 30

Version A - Standard

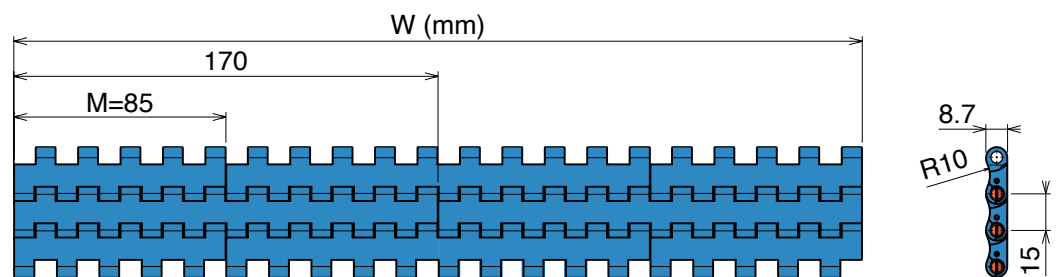

Version B - With 1 Positioner

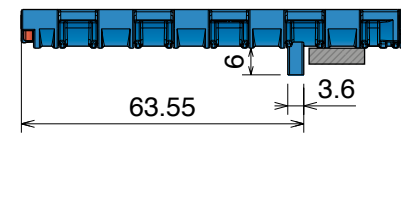

Version C - With 2 Positioners

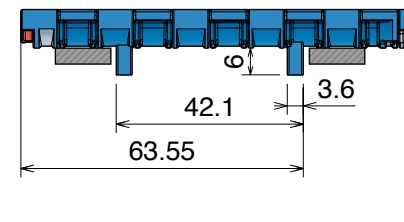

Version A - Standard

Series	Material	Width	Version
5261	*	0085	A
5261	*	0170	A
5261	*	0255	A
5261	*	0340	A
5261	*	0425	A
5261	*	0510	A
5261	*	0595	A
5261	*	0680	A
5261	*	0765	A
5261	*	0850	A
5261	*	0935	A
5261	*	1020	A
5261	*	1105	A
5261	*	1190	A
5261	*	1275	A
5261	*	1360	A
5261	*	1445	A
5261	*	1530	A

Version B - With 1 Positioner

Series	Material	Width	Version
5261	*	0085	B
5261	*	0170	B
5261	*	0255	B
5261	*	0340	B
5261	*	0425	B
5261	*	0510	B
5261	*	0595	B
5261	*	0680	B
5261	*	0765	B
5261	*	0850	B
5261	*	0935	B
5261	*	1020	B
5261	*	1105	B
5261	*	1190	B
5261	*	1275	B
5261	*	1360	B
5261	*	1445	B
5261	*	1530	B

Version C - With 2 Positioners

Series	Material	Width	Version
5261	*	0085	C
5261	*	0170	C
5261	*	0255	C
5261	*	0340	C
5261	*	0425	C
5261	*	0510	C
5261	*	0595	C
5261	*	0680	C
5261	*	0765	C
5261	*	0850	C
5261	*	0935	C
5261	*	1020	C
5261	*	1105	C
5261	*	1190	C
5261	*	1275	C
5261	*	1360	C
5261	*	1445	C
5261	*	1530	C

Belts wider than standard are available with 85 mm increments

525 HD FG Open Surface 35%

Tappeto Modulare 525 HD Flush grid, H=8,7 M=85
 Modular Belt Series 525 HD Flush grid, H=8,7 M=85 / Modulare Mattenkette 525 HD Flush grid, H=8,7 M=85

CODE STRUCTURE GUIDE (Example)

Backflex radius min.: 25 mm

5262	01	0085	A
Series	*Material	Width	Version

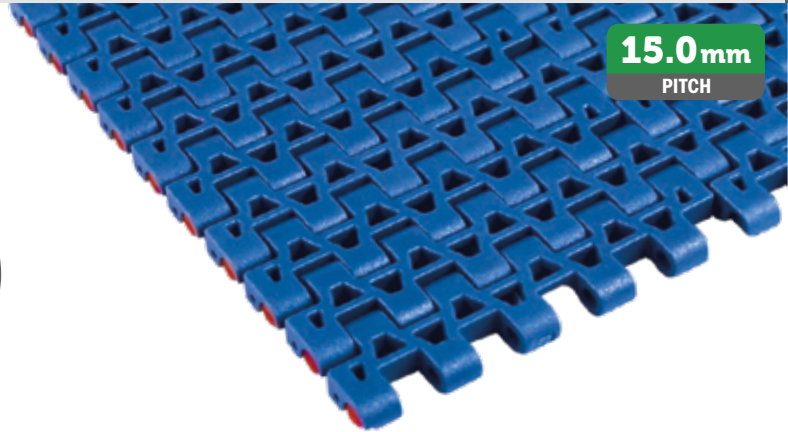

RAL 5005



*Material

LFB - Code 23
 Low friction Acetal

Max w. load: 25500 N/m
 Weight: 8,1 kg/m²
 Temp. range dry: -40÷80 °C
 Temp. range wet: -40÷65 °C
 Pin material: PBT white

Other Material available:

LFA - Code 01

MX - Code 03

PFX - Code 30

Version A - Standard

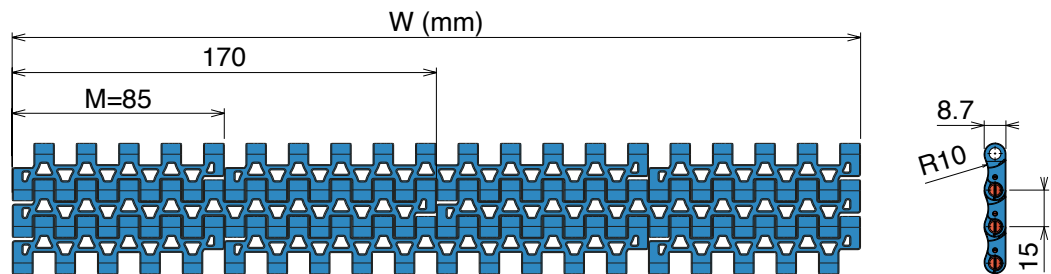

Version B - With 1 Positioner

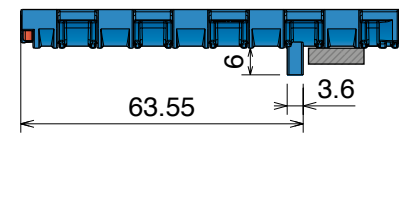

Version A - Standard

Series	Material	Width	Version
5262	*	0085	A
5262	*	0170	A
5262	*	0255	A
5262	*	0340	A
5262	*	0425	A
5262	*	0510	A
5262	*	0595	A
5262	*	0680	A
5262	*	0765	A
5262	*	0850	A
5262	*	0935	A
5262	*	1020	A
5262	*	1105	A
5262	*	1190	A
5262	*	1275	A
5262	*	1360	A
5262	*	1445	A
5262	*	1530	A

Version B - With 1 Positioner

Series	Material	Width	Version
5262	*	0085	B
5262	*	0170	B
5262	*	0255	B
5262	*	0340	B
5262	*	0425	B
5262	*	0510	B
5262	*	0595	B
5262	*	0680	B
5262	*	0765	B
5262	*	0850	B
5262	*	0935	B
5262	*	1020	B
5262	*	1105	B
5262	*	1190	B
5262	*	1275	B
5262	*	1360	B
5262	*	1445	B
5262	*	1530	B

Version C - With 2 Positioners

Series	Material	Width	Version
5262	*	0085	C
5262	*	0170	C
5262	*	0255	C
5262	*	0340	C
5262	*	0425	C
5262	*	0510	C
5262	*	0595	C
5262	*	0680	C
5262	*	0765	C
5262	*	0850	C
5262	*	0935	C
5262	*	1020	C
5262	*	1105	C
5262	*	1190	C
5262	*	1275	C
5262	*	1360	C
5262	*	1445	C
5262	*	1530	C

Belts wider than standard are available with 85 mm increments

550 FT

Tappeto Modulare 550 FT, H=8,7 M=85
Modular Belt Series 550 FT, H=8,7 M=85 / Modulare Mattenkette 550 FT, H=8,7 M=85

CODE STRUCTURE GUIDE (Example)

Backflex radius min.: 25 mm

5501	01	0085	A
Series	*Material	Width	Version

25.4mm
PITCH

RAL 5005



- Easier installation
- Quicker maintenance
- 100% interchangeable

*Material

LFB - Code 23
Low friction Acetal

Max w. load: 30000 N/m
Weight: 8,5 kg/m²
Temp. range dry: -40÷80 °C
Temp. range wet: -40÷65 °C
Pin material: PBT white

Other Material available:

LFA - Code 01

PP - Code 02

MX - Code 03

LFN - Code 05

DKM - Code 16

MWX - Code 17

PFX - Code 30

Version A - Standard

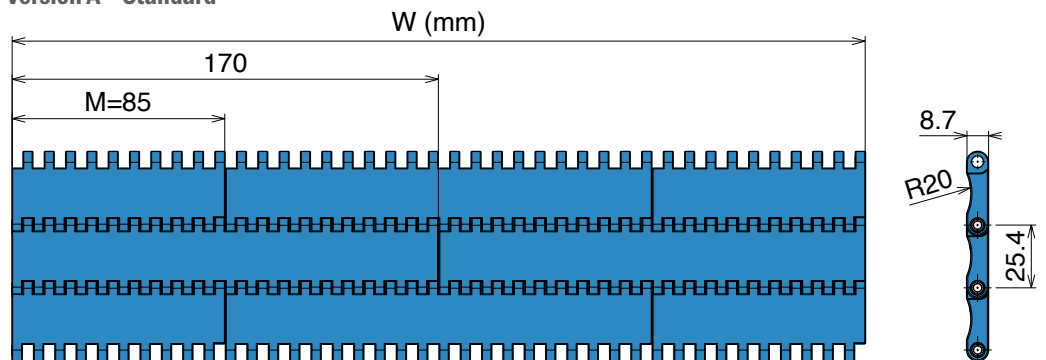

Version B - With 1 Positioner

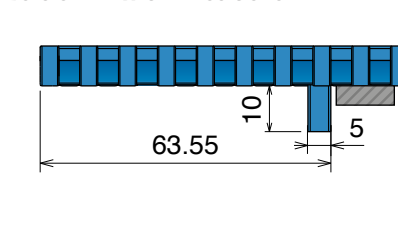

Version C - With 2 Positioner

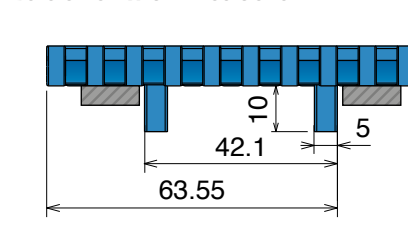

Version A - Standard

Series	Material	Width	Version
5501	*	0085	A
5501	*	0170	A
5501	*	0255	A
5501	*	0340	A
5501	*	0425	A
5501	*	0510	A
5501	*	0595	A
5501	*	0680	A
5501	*	0765	A
5501	*	0850	A
5501	*	0935	A
5501	*	1020	A
5501	*	1105	A
5501	*	1190	A
5501	*	1275	A
5501	*	1360	A
5501	*	1445	A
5501	*	1530	A

Version B - With 1 Positioner

Series	Material	Width	Version
5501	*	0085	B
5501	*	0170	B
5501	*	0255	B
5501	*	0340	B
5501	*	0425	B
5501	*	0510	B
5501	*	0595	B
5501	*	0680	B
5501	*	0765	B
5501	*	0850	B
5501	*	0935	B
5501	*	1020	B
5501	*	1105	B
5501	*	1190	B
5501	*	1275	B
5501	*	1360	B
5501	*	1445	B
5501	*	1530	B

Version C - With 2 Positioners

Series	Material	Width	Version
5501	*	0085	C
5501	*	0170	C
5501	*	0255	C
5501	*	0340	C
5501	*	0425	C
5501	*	0510	C
5501	*	0595	C
5501	*	0680	C
5501	*	0765	C
5501	*	0850	C
5501	*	0935	C
5501	*	1020	C
5501	*	1105	C
5501	*	1190	C
5501	*	1275	C
5501	*	1360	C
5501	*	1445	C
5501	*	1530	C

Belts wider than standard are available with 85 mm increments

550 FT *One track Belt* Tappeto Modulare 550 FT, H=8,7 K330 Modular Belt Series 550 FT, H=8,7 K330 / Modulare Mattenkette 550 FT, H=8,7 K330

CODE STRUCTURE GUIDE (Example)

Backflex radius min.: 25 mm

5221	01	9330	A
Series	*Material	Width	Version

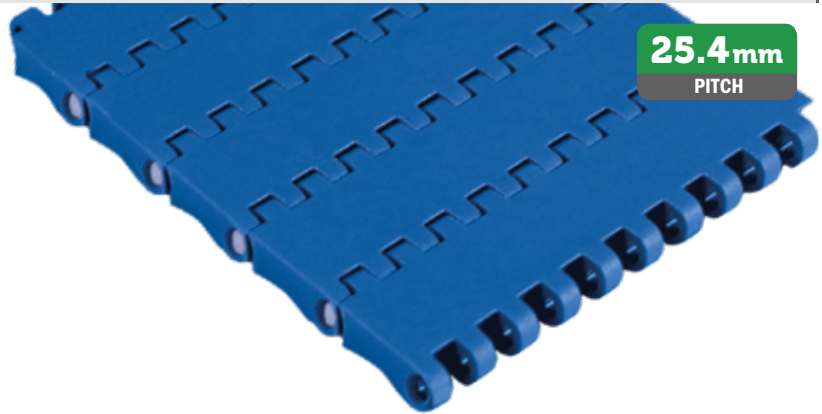

RAL 5005



- Easier installation
- Quicker maintenance
- 10% Higher strength

*Material

LFB - Code 23
Low friction Acetal

Max w. load: 2500 N
Weight: 8,5 kg/m²
Temp. range dry: -40÷80 °C
Temp. range wet: -40÷65 °C
Pin material: PBT white

Other Material available:

LFA - Code 01

PP - Code 02

MX - Code 03

LFN - Code 05

DKM - Code 16

MWX - Code 17

PFX - Code 30

Version A - Standard

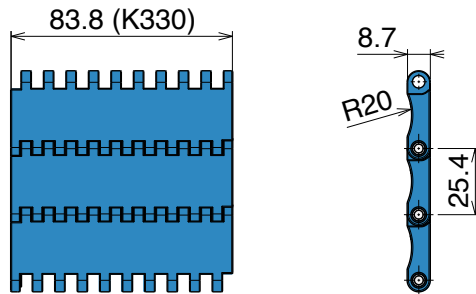

Series	Material	Width	Version
5221	*	9330	A

Version C - With 2 Positioner

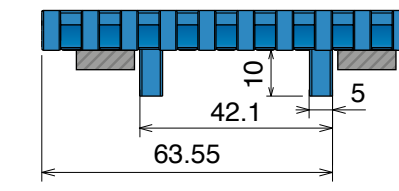

Series	Material	Width	Version
5221	*	9330	C

550 FG Open Surface 25% Tappeto Modulare 550 FG, H=8,7 M=85

Modular Belt Series 550 FG, H=8,7 M=85 / Modulare Mattenkette 550 FG, H=8,7 M=85

CODE STRUCTURE GUIDE (Example)

Backflex radius min.: 25 mm

5222	01	0085	A
Series	*Material	Width	Version

25.4mm
PITCH

RAL 5005

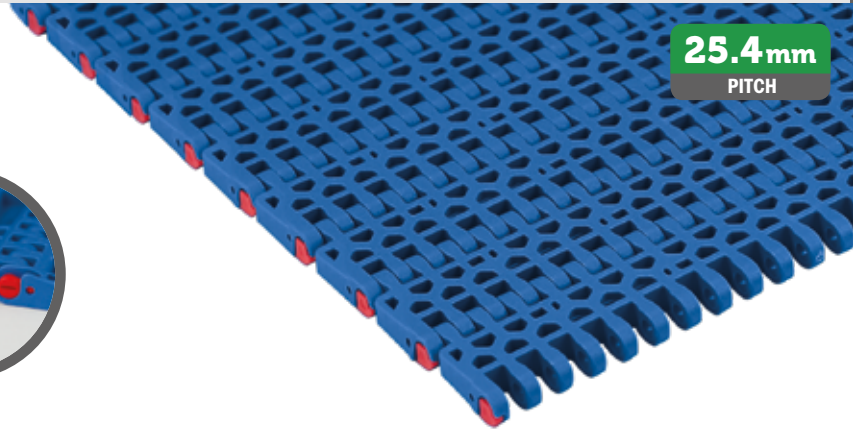
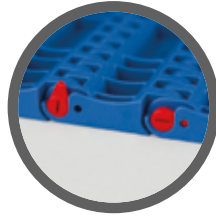

*Material

LFB - Code 23
Low friction Acetal

Max w. load: 27500 N/m
Weight: 7,0 kg/m²
Temp. range dry: -40+80 °C
Temp. range wet: -40+65 °C
Pin material: PBT white

Other Material available:

LFA - Code 01

MX - Code 03

PFX - Code 30

Version A - Standard

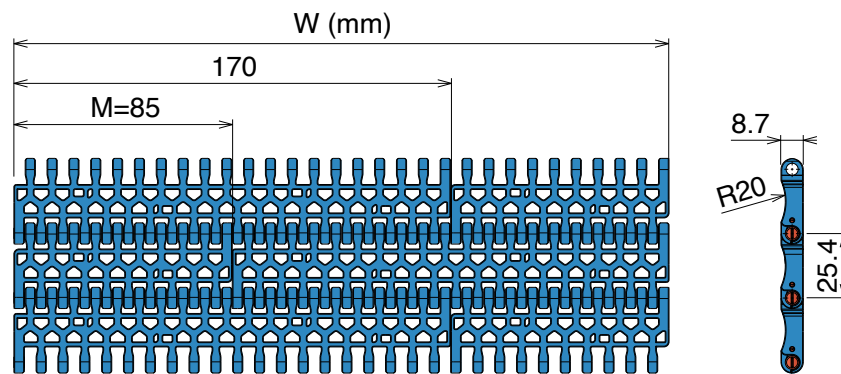

Version B - With 1 Positioner

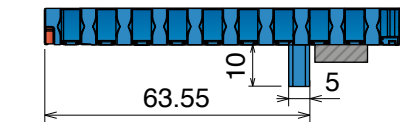

Version C - With 2 Positioners

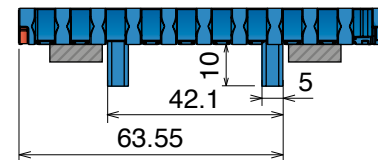

Version A - Standard

Series	Material	Width	Version
5222	*	0085	A
5222	*	0170	A
5222	*	0255	A
5222	*	0340	A
5222	*	0425	A
5222	*	0510	A
5222	*	0595	A
5222	*	0680	A
5222	*	0765	A
5222	*	0850	A
5222	*	0935	A
5222	*	1020	A
5222	*	1105	A
5222	*	1190	A
5222	*	1275	A
5222	*	1360	A
5222	*	1445	A
5222	*	1530	A

Version B - With 1 Positioner

Series	Material	Width	Version
5222	*	0085	B
5222	*	0170	B
5222	*	0255	B
5222	*	0340	B
5222	*	0425	B
5222	*	0510	B
5222	*	0595	B
5222	*	0680	B
5222	*	0765	B
5222	*	0850	B
5222	*	0935	B
5222	*	1020	B
5222	*	1105	B
5222	*	1190	B
5222	*	1275	B
5222	*	1360	B
5222	*	1445	B
5222	*	1530	B

Version C - With 2 Positioners

Series	Material	Width	Version
5222	*	0085	C
5222	*	0170	C
5222	*	0255	C
5222	*	0340	C
5222	*	0425	C
5222	*	0510	C
5222	*	0595	C
5222	*	0680	C
5222	*	0765	C
5222	*	0850	C
5222	*	0935	C
5222	*	1020	C
5222	*	1105	C
5222	*	1190	C
5222	*	1275	C
5222	*	1360	C
5222	*	1445	C
5222	*	1530	C

Belts wider than standard are available with 85 mm increments

550 FG *One track Belt Open Surface 25%* Tappeto Modulare 550 FG, H=8,7 K330 Modular Belt Series 550 FG, H=8,7 K330 / Modulare Mattenkette 550 FG, H=8,7 K330

CODE STRUCTURE GUIDE (Example)

Backflex radius min.: 25 mm

5222	01	9330	A
Series	*Material	Width	Version

25.4mm
PITCH

RAL 5005

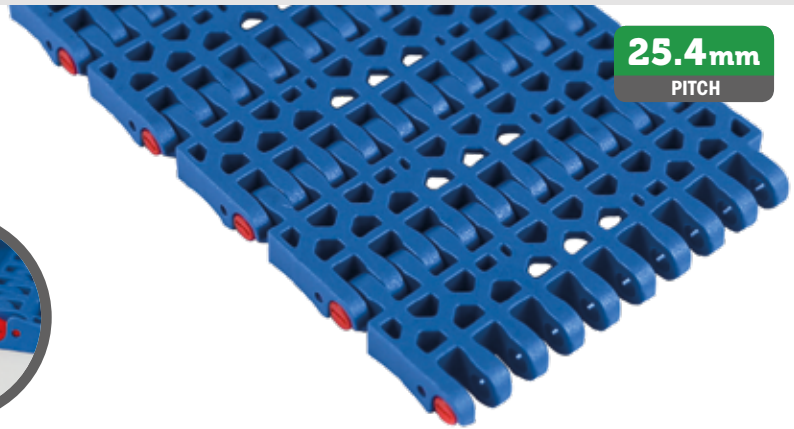
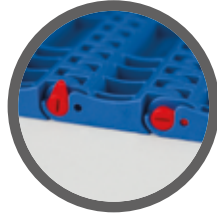

*Material

LFB - Code 23
Low friction Acetal

Max w. load: 2300 N
 Weight: 7,0 kg/m²
 Temp. range dry: -40÷80 °C
 Temp. range wet: -40÷65 °C
 Pin material: PBT white

Other Material available:

LFA - Code 01

MX - Code 03

PFX - Code 30

Version A - Standard

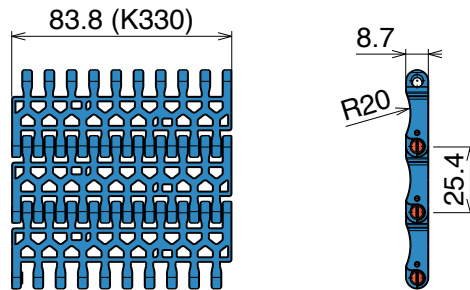

Version C - With 2 Positioner

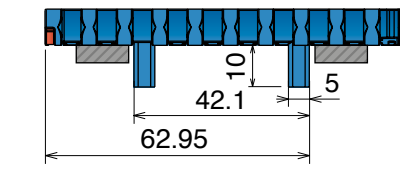

Version A - Standard

Series	Material	Width	Version
5222	*	9330	A

Version C - With 2 Positioners

Series	Material	Width	Version
5222	*	9330	C

550 FLIGHT TOP

Tappeto Modulare 550 with Flight, H=8,7 M=85
 Modular Belt Series 550 with Flight, H=8,7 M=85 / Modulare Mattenkette 550 with Flight, H=8,7 M=85

CODE STRUCTURE GUIDE

Backflex radius min.: 30 mm

See table inside the catalog page 223

RAL 5005

25.4mm
PITCH



- Easier installation
- Quicker maintenance
- 100% interchangeable

*Material

LFB - Code 23
Low friction Acetal

Max w. load: 30000 N/m
Weight: 8,5 kg/m²
Temp. range dry: -40÷80 °C
Temp. range wet: -40÷65 °C
Pin material: PBT white

Other Material available:

LFA - Code 01

PP - Code 02

LFW - Code 05

PPW - Code 21

Version A - Standard

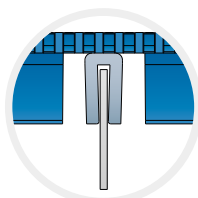
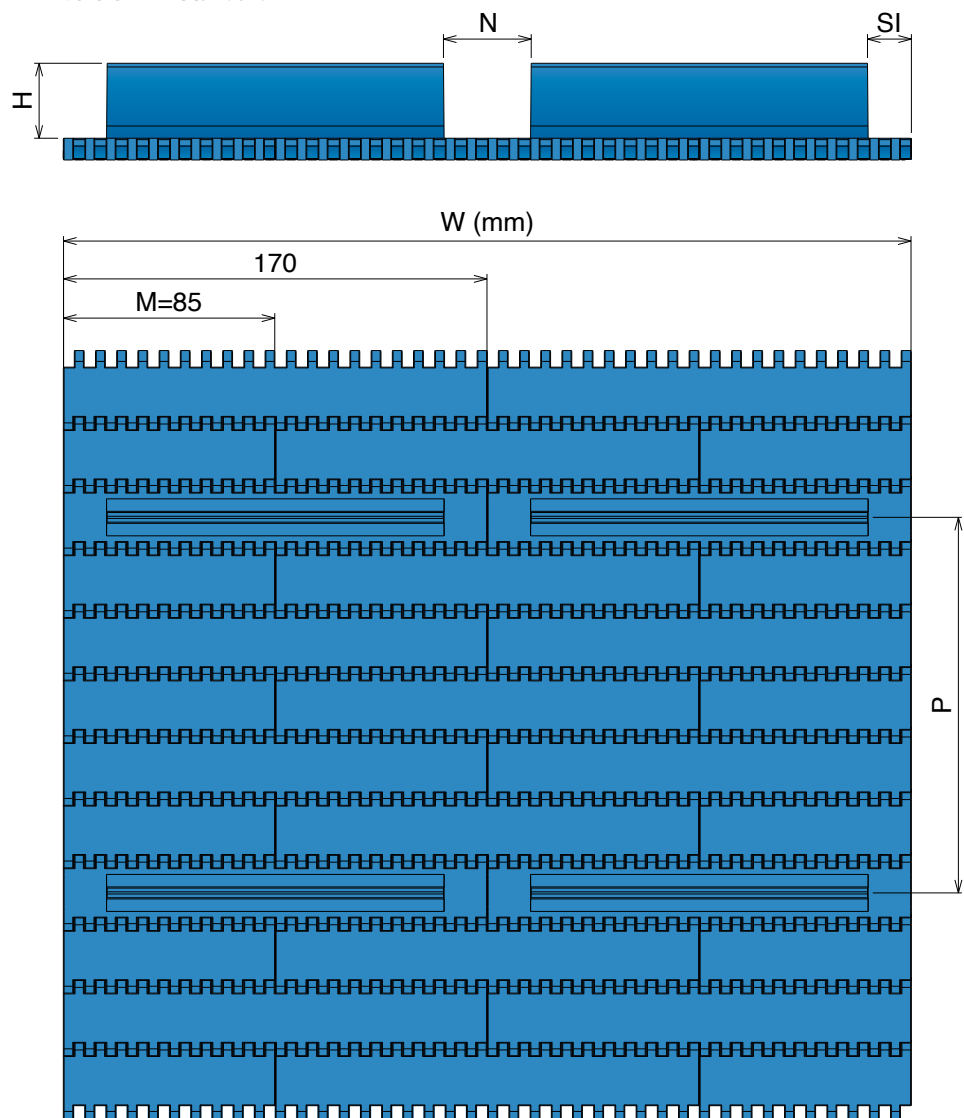

Notch utility
RETURN SECTION
with Bar-cap

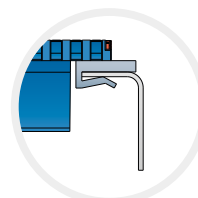

Side indent utility
RETURN SECTION
with Z-Profile & J-Profile

556 FT Open Surface 25%

Tappeto Modulare Curvilineo Serie 556 FT, H=12,7 M=3"
 Side Flex Modular Belt Series 556 FT, H=12,7 M=3" / Kurvengängige Mattenkette Serie 556 FT, H=12,7 M=3"

CODE STRUCTURE GUIDE (Example)

Backflex radius min.: 25 mm

5431	01	0009	A
Series	*Material	Width	Version

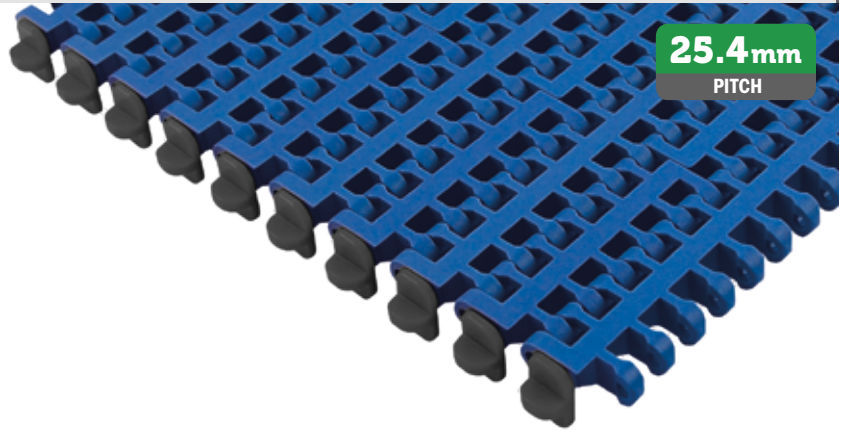

RAL 5005

* Material

LFB - Code 23
 Low friction Acetal

Max w. load:
 Straight: 30000 N/m
 Curve: 2000 N
Weight: 7,5 kg/m²
Temp. range dry: -40÷80 °C
Temp. range wet: -40÷65 °C
Pin material: PBT white

Other Material available:

LFA - Code 01

PPB - Code 24

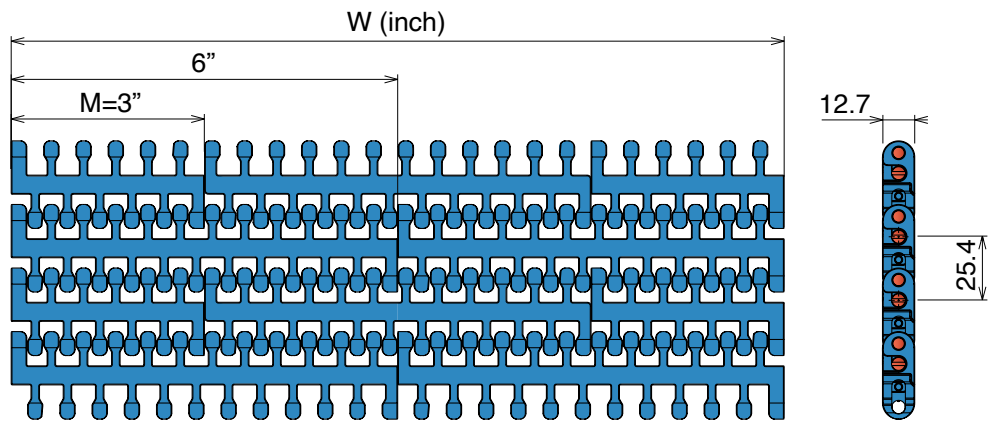

STANDARD

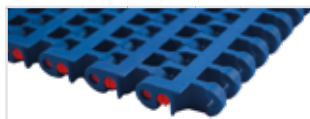

Series	Material	Width	Version	min radius
5431	*	0003	A	145
5431	*	0006	A	290
5431	*	0009	A	435
5431	*	0012	A	580
5431	*	0015	A	725
5431	*	0018	A	890
5431	*	0021	A	1040
5431	*	0024	A	1250

TAB

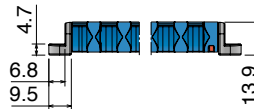

Series	Material	Width	Version	min radius
5431	*	0003	B	145
5431	*	0006	B	290
5431	*	0009	B	435
5431	*	0012	B	580
5431	*	0015	B	725
5431	*	0018	B	890
5431	*	0021	B	1040
5431	*	0024	B	1250

TAB/POSITIONER

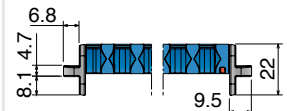

Series	Material	Width	Version	min radius
5431	*	0003	C	145
5431	*	0006	C	290
5431	*	0009	C	435
5431	*	0012	C	580
5431	*	0015	C	725
5431	*	0018	C	890
5431	*	0021	C	1040
5431	*	0024	C	1250

Belts wider than standard are available with 3 inch increments

556 GT **Open Surface 25%** Tappeto Modulare Curvilineo Serie 556 GT, H=12,7 M=3” Side Flex Modular Belt Series 556 GT, H=12,7 M=3” / Kurvengängige Mattenkette Serie 556 GT, H=12,7 M=3”

CODE STRUCTURE GUIDE (Example)

Backflex radius min.: 25 mm

5433	01	0009	A
Series	*Material	Width	Version

RAL 5005

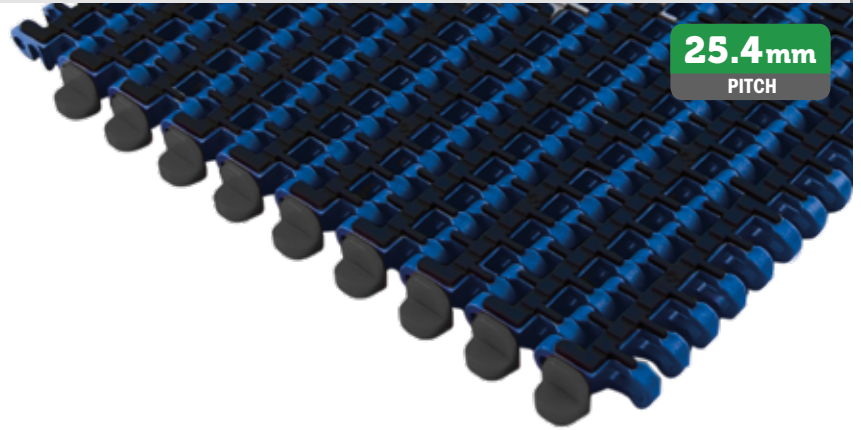

25.4mm
PITCH

*Material

LFB - Code 23
Low friction Acetal

Max w. load:

Straight: 30000 N/m
Curve: 2000 N
Weight: 7,7 kg/m²
Temp. range dry: -40÷80 °C
Temp. range wet: -40÷65 °C
Pin material: PBT white
Top rubber: 50 ShA-Black

Other Material available:

LFA - Code 01

PPB - Code 24

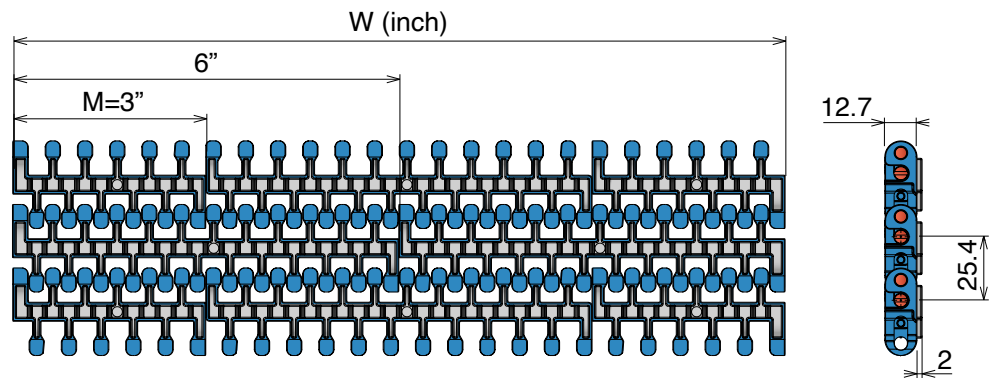

STANDARD



Series	Material	Width	Version	min radius
5433	*	0003	A	145
5433	*	0006	A	290
5433	*	0009	A	435
5433	*	0012	A	580
5433	*	0015	A	725
5433	*	0018	A	890
5433	*	0021	A	1040
5433	*	0024	A	1250

TAB

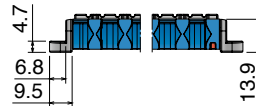

Series	Material	Width	Version	min radius
5433	*	0003	B	145
5433	*	0006	B	290
5433	*	0009	B	435
5433	*	0012	B	580
5433	*	0015	B	725
5433	*	0018	B	890
5433	*	0021	B	1040
5433	*	0024	B	1250

TAB/POSITIONER

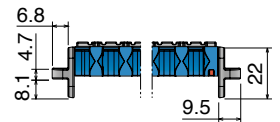

Series	Material	Width	Version	min radius
5433	*	0003	C	145
5433	*	0006	C	290
5433	*	0009	C	435
5433	*	0012	C	580
5433	*	0015	C	725
5433	*	0018	C	890
5433	*	0021	C	1040
5433	*	0024	C	1250

Belts wider than standard are available with 3 inch increments

600 Standard

Tappeto Modulare Curvilineo Serie 600, H=12,7 M=85
 Side Flex Modular Belt Series 600, H=12,7 M=85 / Kurvengängige Mattenkette Serie 600, H=12,7 M=85

CODE STRUCTURE GUIDE (Example)

Backflex radius min.: 25 mm

5421	01	0255	A
Series	*Material	Width	Version

29.5%
OPEN SURFACE

31.75 mm
PITCH

RAL 5005

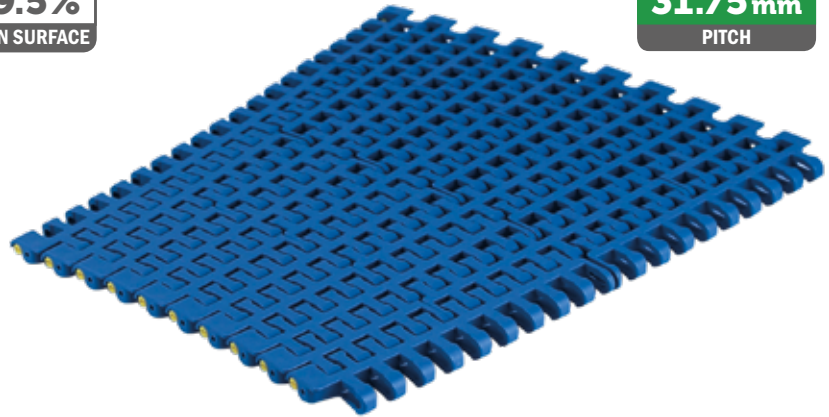

* Material

LFB - Code 23
Low friction Acetal

Max w. load:
 Straight 30000 N/m
 Curve 2500 N
Weight: 7,7 kg/m²
Temp. range dry: -40÷80 °C
Temp. range wet: -40÷65 °C
Pin material: PBT white

Other Material available:

LFA - Code 01

Internal Min Radius
2 times the width

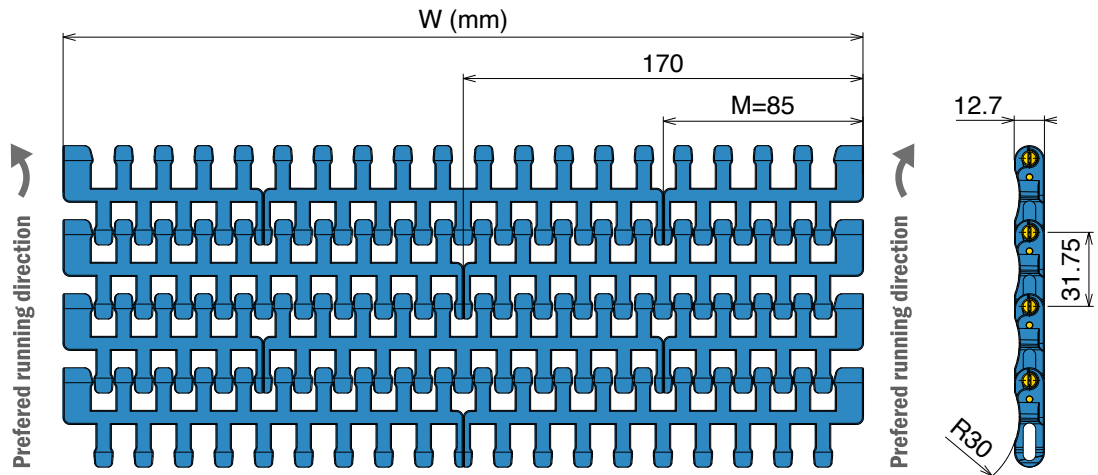

STANDARD

TAB

REVERSE TAB

TAB REVERSE TAB

Series	Material	Width	Version	min radius
5421	*	0255	A	510
5421	*	0340	A	680
5421	*	0425	A	850
5421	*	0510	A	1020
5421	*	0595	A	1190
5421	*	0680	A	1360
5421	*	0765	A	1530
5421	*	0850	A	1700

Series	Material	Width	Version	min radius
5421	*	0255	B	510
5421	*	0340	B	680
5421	*	0425	B	850
5421	*	0510	B	1020
5421	*	0595	B	1190
5421	*	0680	B	1360
5421	*	0765	B	1530
5421	*	0850	B	1700

Series	Material	Width	Version	min radius
5421	*	0255	C	510
5421	*	0340	C	680
5421	*	0425	C	850
5421	*	0510	C	1020
5421	*	0595	C	1190
5421	*	0680	C	1360
5421	*	0765	C	1530
5421	*	0850	C	1700

Series	Material	Width	Version	min radius
5421	*	0255	D	510
5421	*	0340	D	680
5421	*	0425	D	850
5421	*	0510	D	1020
5421	*	0595	D	1190
5421	*	0680	D	1360
5421	*	0765	D	1530
5421	*	0850	D	1700

Belts wider than standard are available with 85 mm increments

600 Heavy duty

Tappeto Modulare Curvilineo Serie 600, H=12,7 M=85
Side Flex Modular Belt Series 600, H=12,7 M=85 / Kurvengängige Mattenkette Serie 600, H=12,7 M=85

CODE STRUCTURE GUIDE (Example)

Backflex radius min.: 25 mm

5422	01	0255	E
Series	*Material	Width	Version

27.5%
OPEN SURFACE

31.75 mm
PITCH

RAL 5005

RANGE EXTENSION

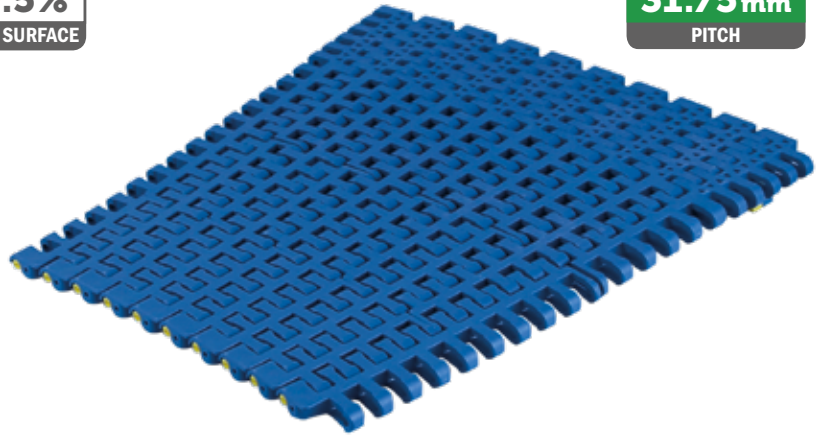

*Material

LFB - Code 23
Low friction Acetal

Max w. load:
Straight 30000 N/m
Curve 3500 N
Weight: 8,3 kg/m²
Temp. range dry: -40+80 °C
Temp. range wet: -40+65 °C
Pin material: PBT white

Other Material available:

LFA - Code 01

Internal Min Radius
2 times the width

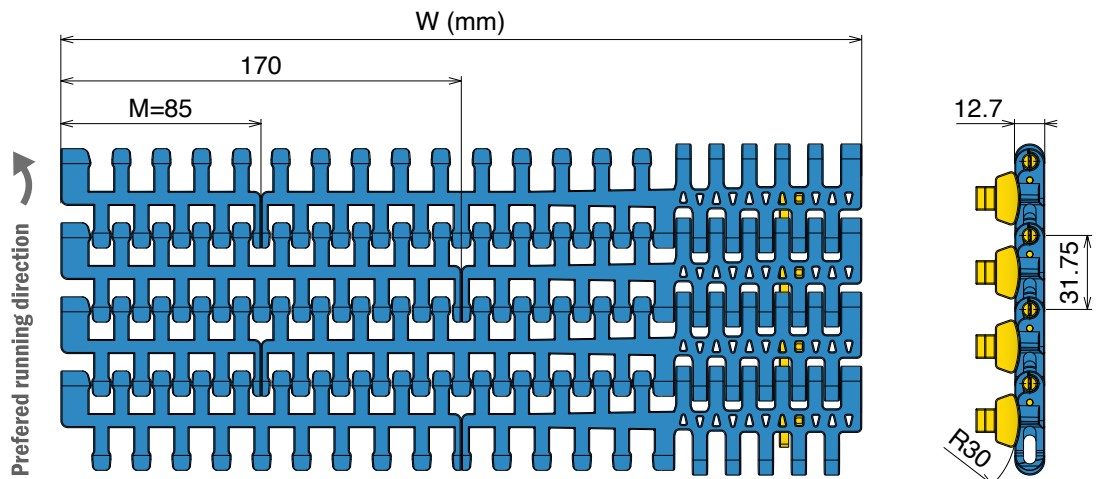

STANDARD

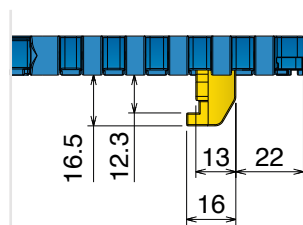

Series	Material	Width	Version	min radius
5422	*	0255	E	510
5422	*	0340	E	680
5422	*	0425	E	850
5422	*	0510	E	1020
5422	*	0595	E	1190
5422	*	0680	E	1360
5422	*	0765	E	1530
5422	*	0850	E	1700

Belts wider than standard are available with 85 mm increments

TAB DKM Material

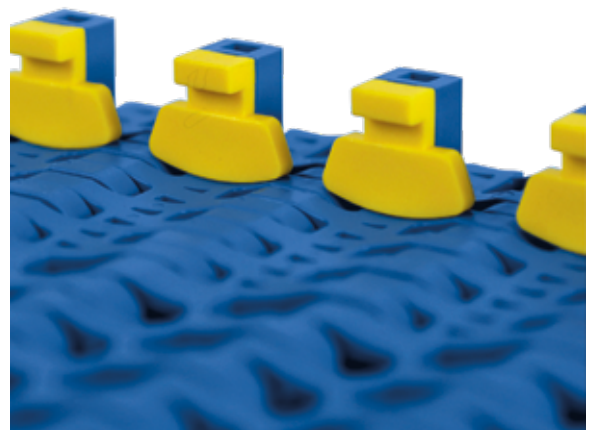

600 Heavy duty with Bearings

Tappeto Modulare Curvilineo Serie 600, H=12,7 M=85
Side Flex Modular Belt Series 600, H=12,7 M=85 / Kurvengängige Mattenkette Serie 600, H=12,7 M=85

CODE STRUCTURE GUIDE (Example)

Backflex radius min.: 25 mm

5422	01	0340	F
Series	*Material	Width	Version

27.5%
OPEN SURFACE

31.75 mm
PITCH

RAL 5005

RANGE EXTENSION

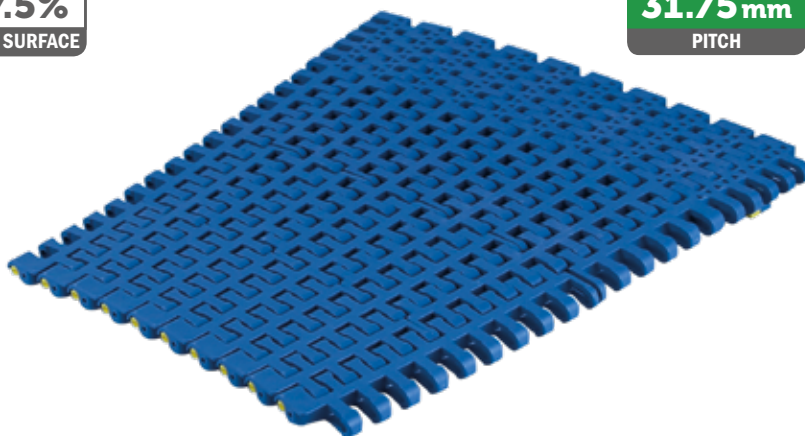

* Material

LFB - Code 23
Low friction Acetal

Max w. load:
Straight 30000 N/m
Curve 3500 N
Weight: 9,0 kg/m²
Temp. range dry: -40÷80 °C
Temp. range wet: -40÷65 °C
Pin material: PBT white

Other Material available:

LFA - Code 01

Internal Min Radius
2 times the width

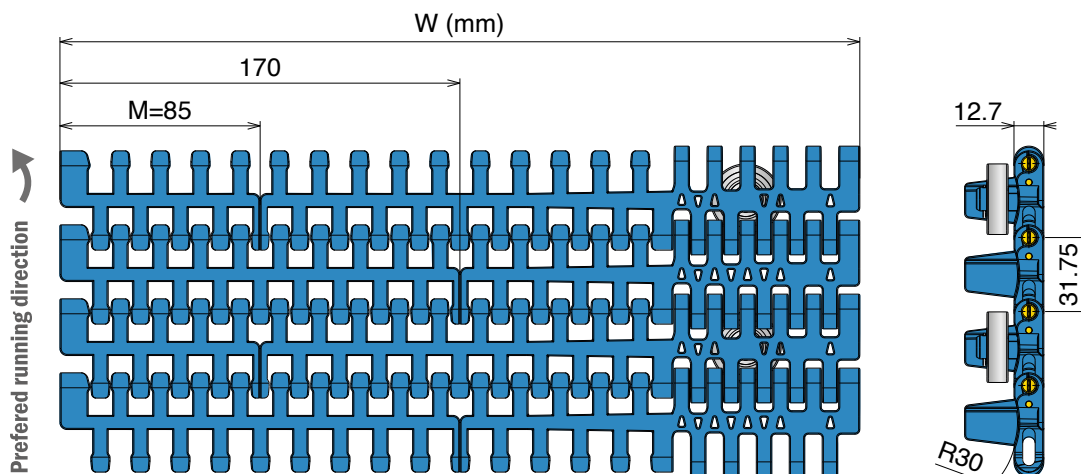

STANDARD

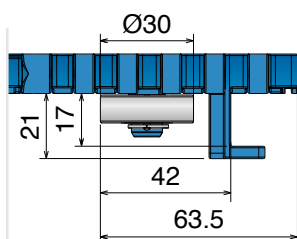

Series	Material	Width	Version	min radius
5422	*	0255	F	510
5422	*	0340	F	680
5422	*	0425	F	850
5422	*	0510	F	1020
5422	*	0595	F	1190
5422	*	0680	F	1360
5422	*	0765	F	1530
5422	*	0850	F	1700

Belts wider than standard
are available
with 85 mm increments

Bearing Zoom



600 *Small radius* Tappeto Modulare Curvilineo Serie 600, H=12,7 M=85 Side Flex Modular Belt Series 600, H=12,7 M=85 / Kurvengängige Mattenkette Serie 600, H=12,7 M=85

CODE STRUCTURE GUIDE (Example)

Backflex radius min.: 25 mm

5423	01	0340	A
Series	*Material	Width	Version

29.5%
OPEN SURFACE

31.75 mm
PITCH

RAL 5005

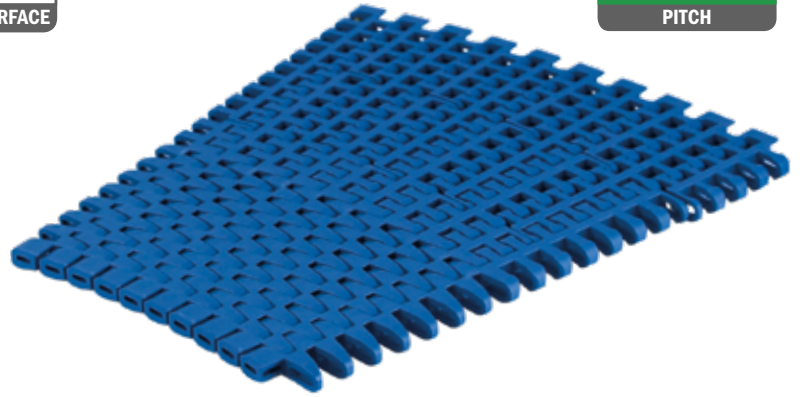

*Material

LFB - Code 23
Low friction Acetal

Max w. load:
Straight 30000 N/m
Curve 2500 N
Weight: 7,0 kg/m²
Temp. range dry: -40+80 °C
Temp. range wet: -40+65 °C
Pin material: PBT white

Other Material available:

LFA - Code 01

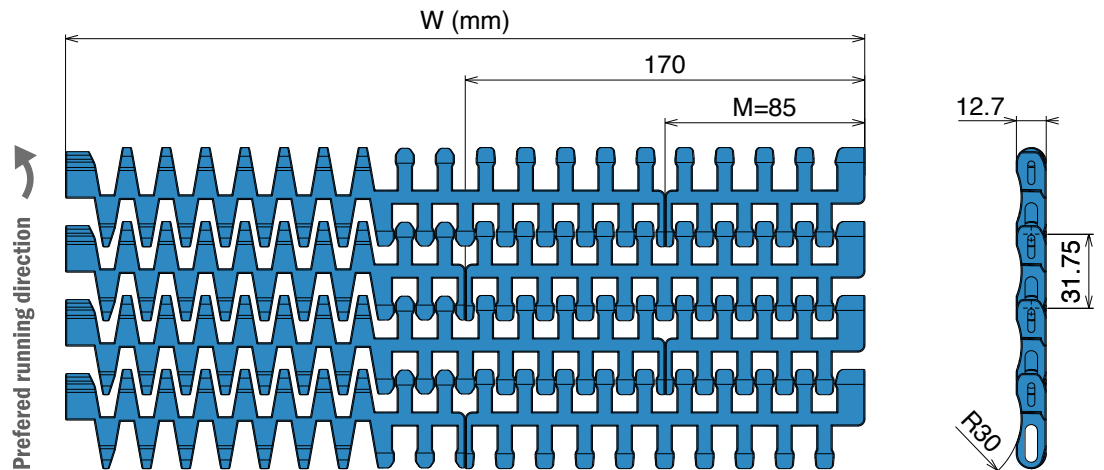

STANDARD

TAB

REVERSE TAB

TAB REVERSE TAB

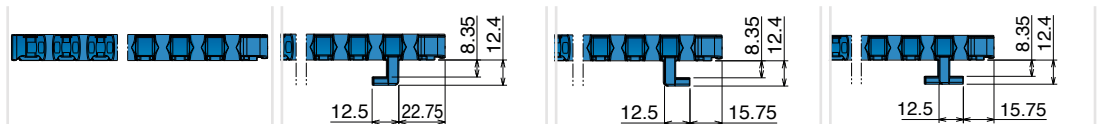

Series	Material	Width	Version	min radius	Series	Material	Width	Version	min radius	Series	Material	Width	Version	min radius	Series	Material	Width	Version	min radius
5423	*	0340	A	400	5423	*	0340	B	400	5423	*	0340	C	400	5423	*	0340	D	400
5423	*	0425	A	500	5423	*	0425	B	500	5423	*	0425	C	500	5423	*	0425	D	500
5423	*	0510	A	600	5423	*	0510	B	600	5423	*	0510	C	600	5423	*	0510	D	600
5423	*	0595	A	720	5423	*	0595	B	720	5423	*	0595	C	720	5423	*	0595	D	720
5423	*	0680	A	880	5423	*	0680	B	880	5423	*	0680	C	880	5423	*	0680	D	880
5423	*	0765	A	1040	5423	*	0765	B	1040	5423	*	0765	C	1040	5423	*	0765	D	1040
5423	*	0850	A	1200	5423	*	0850	B	1200	5423	*	0850	C	1200	5423	*	0850	D	1200

Belts wider than standard are available with 85 mm increments

600 Heavy duty/Small radius

Tappeto Modulare Curvilineo Serie 600, H=12,7 M=170
 Side Flex Modular Belt Series 600, H=12,7 M=170 / Kurvengängige Mattenkette Serie 600, H=12,7 M=170

CODE STRUCTURE GUIDE (Example)

Backflex radius min.: 25 mm

5424	01	0425	E
Series	*Material	Width	Version

27.5%
OPEN SURFACE

31.75 mm
PITCH

RAL 5005

RANGE EXTENSION

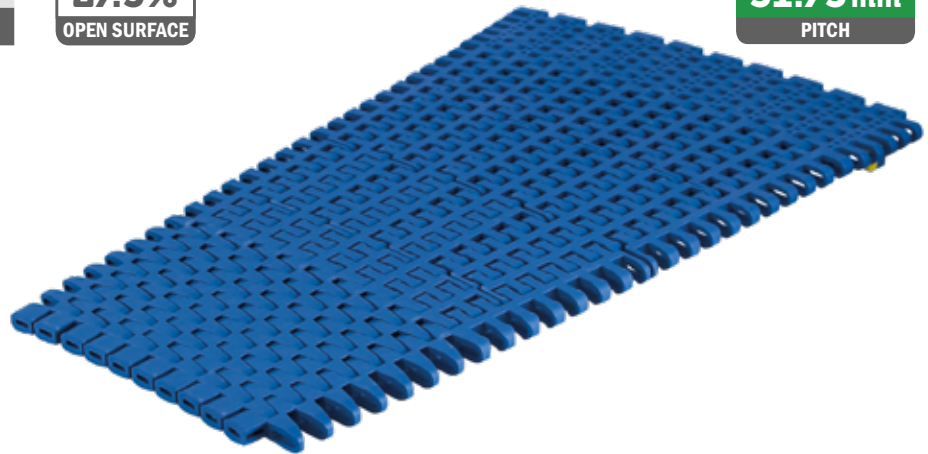

* Material

LFB - Code 23
Low friction Acetal

Max w. load:
 Straight 30000 N/m
 Curve 3500 N
Weight: 7,5 kg/m²
Temp. range dry: -40÷80 °C
Temp. range wet: -40÷65 °C
Pin material: PBT white

Other Material available:

LFA - Code 01

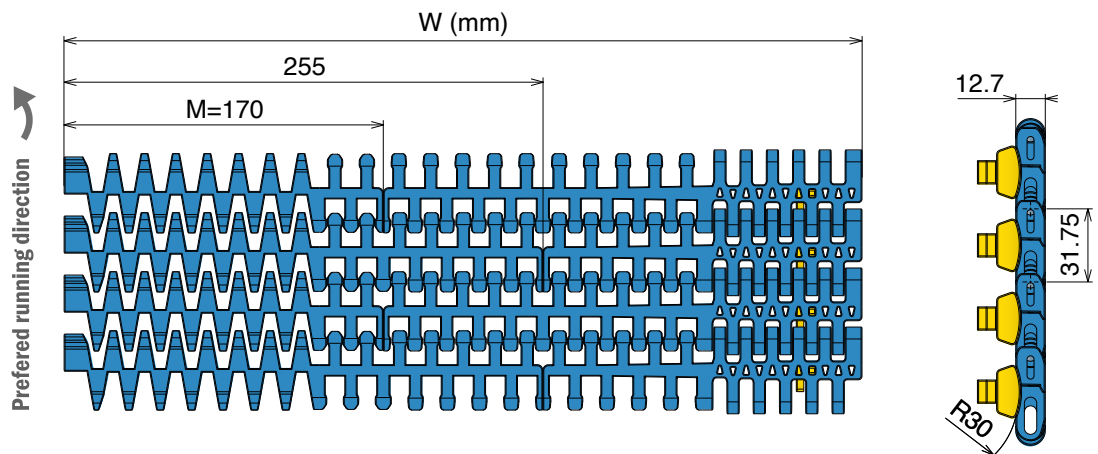

STANDARD

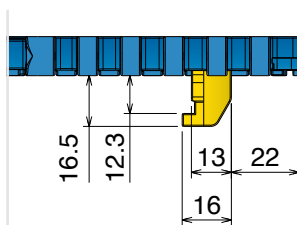

Series	Material	Width	Version	min radius
5424	*	0255	E	390
5424	*	0340	E	420
5424	*	0425	E	500
5424	*	0510	E	600
5424	*	0595	E	720
5424	*	0680	E	880
5424	*	0765	E	1040
5424	*	0850	E	1200

Belts wider than standard
are available
with 85 mm increments

TAB DKM Material

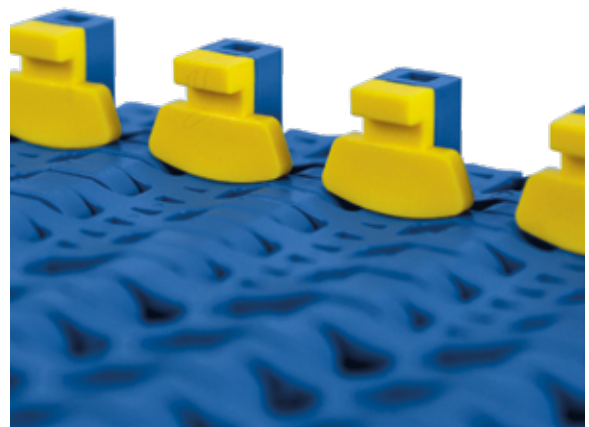

600 Heavy duty/Small radius with Bearings

Tappeto Curvilineo Serie 600, H=12,7 M=170
Side Flex Modular Belt Series 600, H=12,7 M=170 / Kurvengängige Mattenkette Serie 600, H=12,7 M=170

CODE STRUCTURE GUIDE (Example)

Backflex radius min.: 25 mm

5424	01	0425	F
Series	*Material	Width	Version

27.5%
OPEN SURFACE

31.75 mm
PITCH

RAL 5005

RANGE EXTENSION

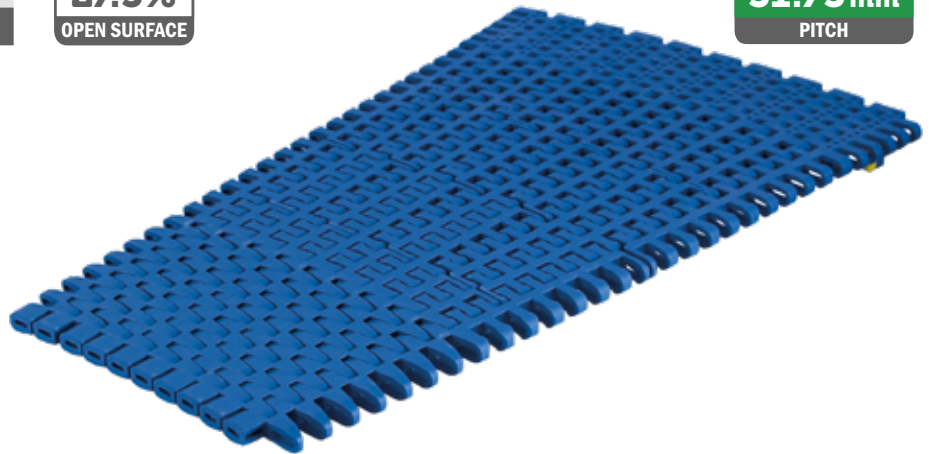

*Material

LFB - Code 23
Low friction Acetal

Max w. load:

Straight 30000 N/m

Curve 3500 N

Weight: 8,5 kg/m²

Temp. range dry: -40+80 °C

Temp. range wet: -40+65 °C

Pin material: PBT white

Other Material available:

LFA - Code 01

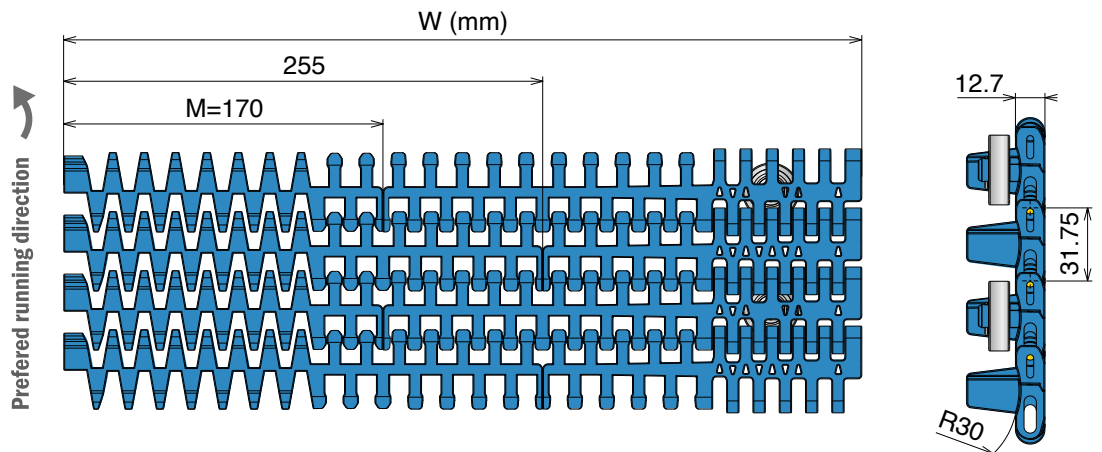

STANDARD

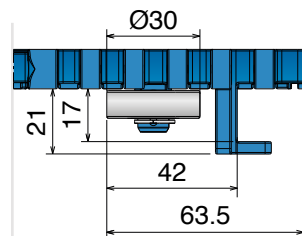

Series	Material	Width	Version	min radius
5424	*	0255	F	390
5424	*	0340	F	420
5424	*	0425	F	500
5424	*	0510	F	600
5424	*	0595	F	720
5424	*	0680	F	880
5424	*	0765	F	1040
5424	*	0850	F	1200

Bearing Zoom



Belts wider than standard are available with 85 mm increments

ZERO CONTACT

Tappeto Modulare Curvilineo Zero Contact™, H=10,1 M=200

Side Flex Modular Belt Zero Contact™, H=10,1 M=200 / Kurvengängige Mattenkette Zero Contact™, H=10,1 M=200

*Material

LFB - Code 23
Low friction Acetal

Max w. load: 13500 N/m
Weight: 9,25 kg/m²
Temp. range dry: -40+80 °C
Temp. range wet: -40+65 °C
Pin material: PBT white

Other Material available:

LFA - Code 01

RAL 5005

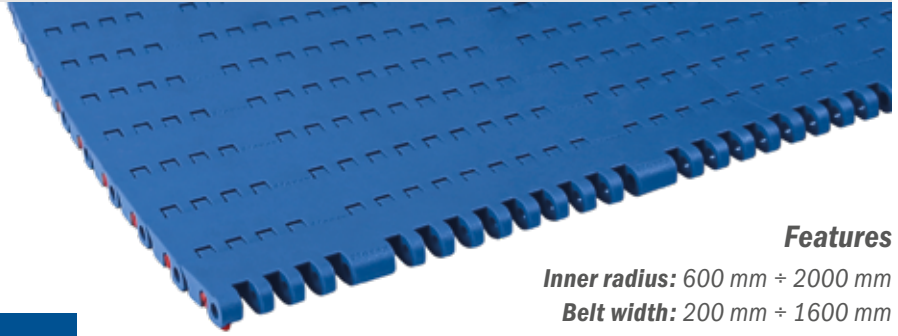

Features

Inner radius: 600 mm ÷ 2000 mm

Belt width: 200 mm ÷ 1600 mm

Angle: 90° and 180° (different on request)

Row to row angle: 1,33°

Pin material: Ø4,7 mm, PBT White **Open Area: 0%**

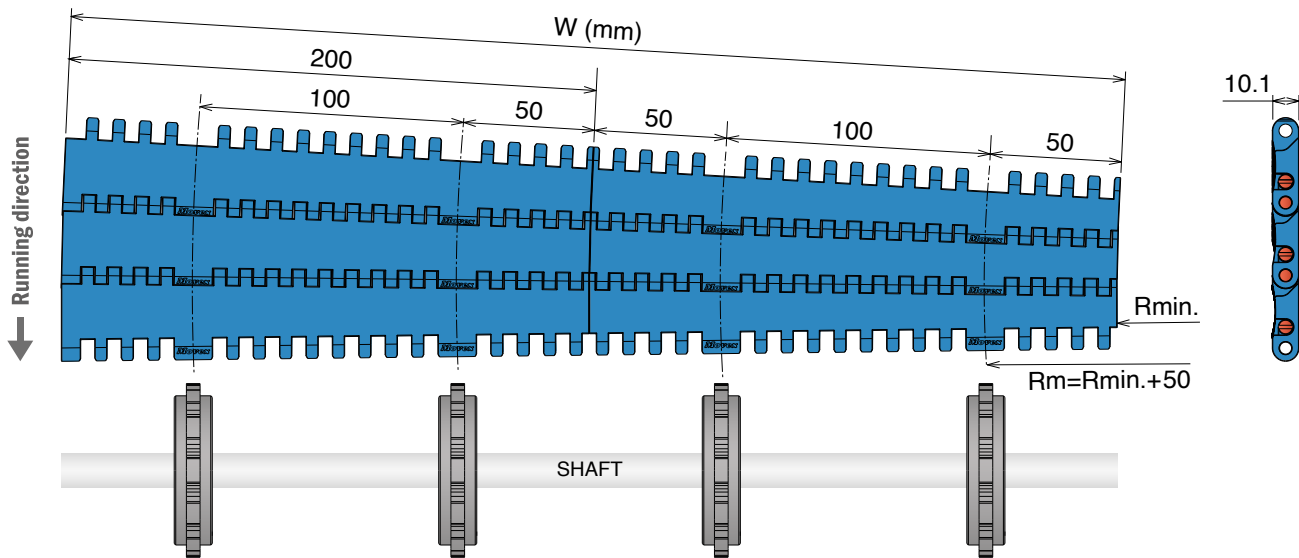

Side Flex Modular Belt Zero Contact™ 90° | Length of the belt 150 Modules

Belt Width	R _i 600	R _i 800	R _i 1000	R _i 1200	R _i 1400	R _i 1600	R _i 1800	R _i 2000	Material
200	5451230201A	5451230202A	5451230203A	5451230204A	5451230205A	5451230206A	5451230207A	5451230208A	LFB
400	5451230401A	5451230402A	5451230403A	5451230404A	5451230405A	5451230406A	5451230407A	-	
600	5451230601A	5451230602A	5451230603A	5451230604A	5451230605A	5451230606A	-	-	
800	5451230801A	5451230802A	5451230803A	5451230804A	5451230805A	-	-	-	
1000	5451231001A	5451231002A	5451231003A	5451231004A	-	-	-	-	
1200	5451231201A	5451231202A	5451231203A	-	-	-	-	-	
1400	5451231401A	5451231402A	-	-	-	-	-	-	
1600	5451231601A	-	-	-	-	-	-	-	

Side Flex Modular Belt Zero Contact™ 180° | Length of the belt 285 Modules

Belt Width	R _i 600	R _i 800	R _i 1000	R _i 1200	R _i 1400	R _i 1600	R _i 1800	R _i 2000	Material
200	5452230201A	5452230202A	5452230203A	5452230204A	5452230205A	5452230206A	5452230207A	5452230208A	LFB
400	5452230401A	5452230402A	5452230403A	5452230404A	5452230405A	5452230406A	5452230407A	-	
600	5452230601A	5452230602A	5452230603A	5452230604A	5452230605A	5452230606A	-	-	
800	5452230801A	5452230802A	5452230803A	5452230804A	5452230805A	-	-	-	
1000	5452231001A	5452231002A	5452231003A	5452231004A	-	-	-	-	
1200	5452231201A	5452231202A	5452231203A	-	-	-	-	-	
1400	5452231401A	5452231402A	-	-	-	-	-	-	
1600	5452231601A	-	-	-	-	-	-	-	

The belt is compliant to: EC 1935/2004, Regulation EU 10/2011 - FDA 21 CFR 177.2470

260 M FT

Catena curvilinea
Sideflexing belt/chain / Kurvengängige Mattenkette

MAGNETIC SYSTEM

Delivery: **Easy** **Standard**

Pins: Ferritic SS | Backflex radius min.: 130 mm

25.4 mm
PITCH

RAL 5005

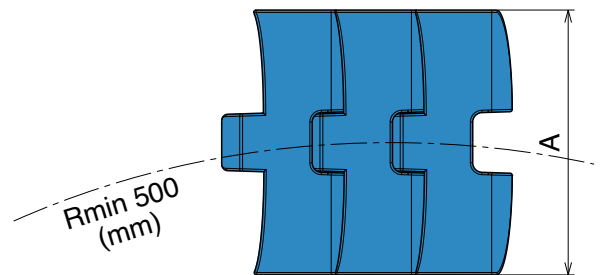
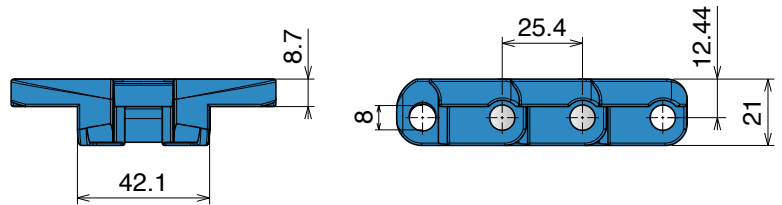

Advantages:

- Heavy duty
- 20% Reduced gap link
- 95% Closed surface

Article-Nr.	Ref.	A (Plate Width) mm	Weight kg/m	Max working load (N)	Sideflex radius mm	Material
11512303	LFA 260 M FT K330	83,8	1,75	2000	500	LFB
11512305	LFA 260 M FT K450	114,3	2,30			

Other Material available:

LFA - Code 01

MX - Code 03

PFX - Code 30

DKM - Code 16

260 M FG

Catena curvilinea
Sideflexing belt/chain / Kurvengängige Mattenkette

MAGNETIC SYSTEM

Delivery: **Easy** **Standard**

Pins: Ferritic SS | Backflex radius min.: 130 mm

25.4 mm
PITCH

RAL 5005

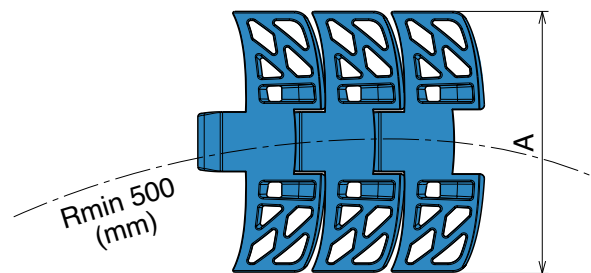
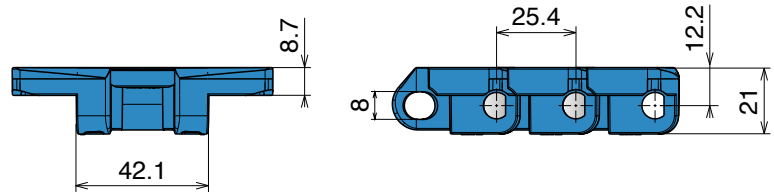
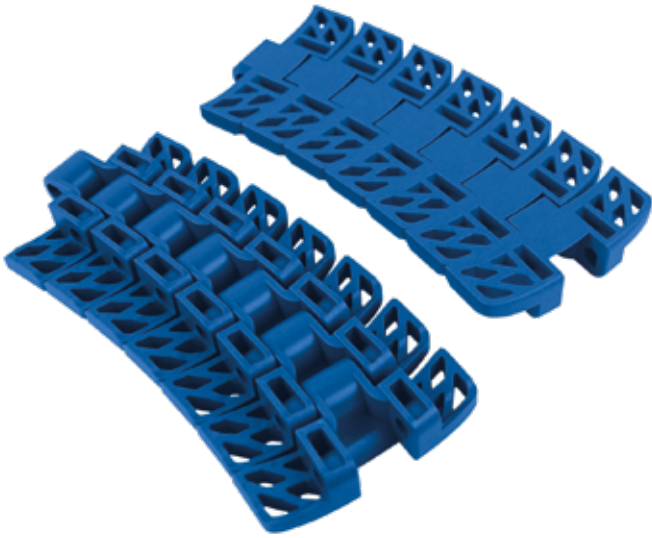

Article-Nr.	Ref.	A (Plate Width) mm	Weight kg/m	Max working load (N)	Sideflex radius mm	Material
11542303	LFB 260 M FG K330	83,8	1,62	2000	500	LFB
11542305	LFB 260 M FG K450	114,3	2,13			

Other Material available:

LFA - Code 01

MX - Code 03

PFX - Code 30

260 TAB

Catena curvilinea
Sideflexing belt/chain / Kurvengängige Mattenkette

TAB SYSTEM

Delivery: **Easy** **Standard**

Pins: Ferritic SS | Backflex radius min.: 130 mm

25.4mm
PITCH

RAL 5005

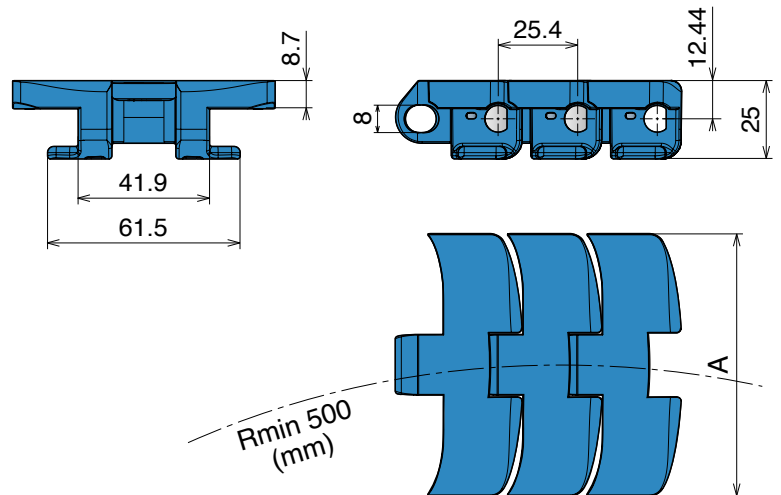

Article-Nr.	Ref.	A (Plate Width) mm	Weight kg/m	Max working load (N)	Sideflex radius mm	Material
11522303	LFB 260 TAB K330	83,8	1,85	2000	500	LFB
11522305	LFB 260 TAB K450	114,3	2,00			

Other Material available:

LFA - Code 01

MX - Code 03

PFX - Code 30

DKM - Code 16



Movex S.p.A.

Headquarter

Viale Industria, 22
24060 Castelli Calepio (BG)

Logistics Center

Via della Repubblica, 21/E
24060 Castelli Calepio (BG)

P +39 035 8359711
info@movexii.co m
www.movexii.com

Movex around the world

Movex GmbH

P +49-6204-9375-0

Movex Brasil Ltda

P +55-15-3141-2550

Movex France

P +39-335-8085980

Movex AG India

P +91-120-4159660-62

Movex Russia

P +7 (495) 925-88-56

Movex UK Ltd.

P +44-77-20678442

Movex Nederland

P +31-630-994850

Movex USA Inc.

P +1-919-274-5477

Movex SA de CV

P +52-1-3318458187

Movex CIS countries

P +380-667507756



movexii.com