

GEARHEAD

RATED TORQUE OF GEARHEAD

● Single-phase 200V/240V

unit = above : N·m / below : kgf·cm

Model Motor/Gearhead	Ratio Speed(rpm)	3	3.6	5	6	7.5	9	10	12.5	15	18	20	25	30	36	40	50	60	75	90	100	120	150	180	200	
		K9R□180F□- SU K9P□BU, BUF	1200	200V/220V 50Hz/60Hz	2.14 21.4	2.57 25.7	3.56 35.6	4.28 42.8	5.35 53.5	6.42 64.2	7.13 71.3	8.02 80.2	9.62 96.2	11.55 115.5	12.83 128.3	14.43 144.3	17.32 173.2	20.79 207.9	23.09 230.9	28.87 288.7	30	30	30	30	30	30
230V 50Hz/60Hz 240V/50Hz	2.31 23.1			2.77 27.7	3.85 38.5	4.62 46.2	5.77 57.7	6.93 69.3	7.70 77.0	8.66 86.6	10.39 103.9	12.47 124.7	13.85 138.5	15.58 155.8	18.70 187.0	22.44 224.4	24.93 249.3	30	30	30	30	30	30	20	30	30
90	200V/220V 50Hz/60Hz		0.73 7.3	0.87 8.7	1.22 12.2	1.46 14.6	1.82 18.2	2.19 21.9	2.43 24.3	2.73 27.3	3.28 32.8	3.94 39.4	4.37 43.7	4.92 49.2	5.90 59.0	7.09 70.9	7.87 78.7	9.84 98.4	11.81 118.1	13.29 132.9	15.94 159.4	17.71 177.1	21.26 212.6	26.57 265.7	30	30
	230V 50Hz/60Hz 240V/50Hz		0.78 7.8	0.93 9.3	1.30 13.0	1.56 15.6	1.94 19.4	2.33 23.3	2.59 25.9	2.92 29.2	3.50 35.0	4.20 42.0	4.67 46.7	5.25 52.5	6.30 63.0	7.56 75.6	8.40 84.0	10.50 105.0	12.60 126.0	14.17 141.7	17.01 170.1	18.90 189.0	22.67 226.7	28.34 283.4	30	30

● Single-phase 100V/115V

unit = above : N·m / below : kgf·cm

Model Motor/Gearhead	Ratio Speed(rpm)	3	3.6	5	6	7.5	9	10	12.5	15	18	20	25	30	36	40	50	60	75	90	100	120	150	180	200	
		K9R□180F□- DK9P□BU	1200	100V 50/60Hz	2.14 21.4	2.57 25.7	3.56 35.6	4.28 42.8	5.35 53.5	6.42 64.2	7.13 71.3	8.02 80.2	9.62 96.2	11.55 115.5	12.83 128.3	14.43 144.3	17.32 173.2	20.79 207.9	23.09 230.9	28.87 288.7	30	30	30	30	30	30
110V/115V 60Hz	2.67 26.7			3.21 32.1	4.46 44.6	5.35 53.5	6.68 66.8	8.02 80.2	8.91 89.1	10.02 100.2	12.03 120.3	14.43 144.3	16.04 160.4	18.04 180.4	21.65 216.5	25.98 259.8	28.87 288.7	30	30	30	30	30	30	30	30	30
90	100V 50/60Hz		0.80 8.0	0.96 9.6	1.34 13.4	1.60 16.0	2.00 20.0	2.41 24.1	2.67 26.7	3.01 30.1	3.61 36.1	4.33 43.3	4.81 48.1	5.41 54.1	6.50 65.0	7.79 77.9	8.66 86.6	10.83 108.3	12.99 129.9	14.61 146.1	17.54 175.4	19.49 194.9	23.38 233.8	29.23 292.3	30	30
	110V/115V 60Hz		0.92 9.2	1.11 11.1	1.54 15.4	1.85 18.5	2.31 23.1	2.77 27.7	3.08 30.8	3.46 34.6	4.16 41.6	4.99 49.9	5.54 55.4	6.23 62.3	7.48 74.8	8.98 89.8	9.97 99.7	12.47 124.7	14.96 149.6	16.83 168.3	20.19 201.9	22.44 224.4	26.93 269.3	30	30	

● Single-phase 200V/240V

unit = above : N·m / below : kgf·cm

Model Motor/Gearhead	Ratio Speed(rpm)	3	3.6	5	6	7.5	9	10	12.5	15	18	20	25	30	36	40	50	60	75	90	100	120	150	180	200	
		K9R□180F□- DK9P□BU	1200	200V/220V 50Hz/60Hz	2.14 21.4	2.57 25.7	3.56 35.6	4.28 42.8	5.35 53.5	6.42 64.2	7.13 71.3	8.02 80.2	9.62 96.2	11.55 115.5	12.83 128.3	14.43 144.3	17.32 173.2	20.79 207.9	23.09 230.9	28.87 288.7	30	30	30	30	30	30
230V 50Hz/60Hz 240V/50Hz	2.31 23.1			2.77 27.7	3.85 38.5	4.62 46.2	5.77 57.7	6.93 69.3	7.70 77.0	8.66 86.6	10.39 103.9	12.47 124.7	13.85 138.5	15.58 155.8	18.70 187.0	22.44 224.4	24.93 249.3	30	30	30	30	30	30	30	30	30
90	200V/220V 50Hz/60Hz		0.73 7.3	0.87 8.7	1.22 12.2	1.46 14.6	1.82 18.2	2.19 21.9	2.43 24.3	2.73 27.3	3.28 32.8	3.94 39.4	4.37 43.7	4.92 49.2	5.90 59.0	7.09 70.9	7.87 78.7	9.84 98.4	11.81 118.1	13.29 132.9	15.94 159.4	17.71 177.1	21.26 212.6	26.57 265.7	30	30
	230V 50Hz/60Hz 240V/50Hz		0.78 7.8	0.93 9.3	1.30 13.0	1.56 15.6	1.94 19.4	2.33 23.3	2.59 25.9	2.92 29.2	3.50 35.0	4.20 42.0	4.67 46.7	5.25 52.5	6.30 63.0	7.56 75.6	8.40 84.0	10.50 105.0	12.60 126.0	14.17 141.7	17.01 170.1	18.90 189.0	22.67 226.7	28.34 283.4	30	30

● Single-phase 100V/115V

unit = above : N·m / below : kgf·cm

Model Motor/Gearhead	Ratio Speed(rpm)	3	3.6	5	6	7.5	9	10	12.5	15	18	20	25	30	36	40	50	60	75	90	100	120	150	180	200	
		K9R□180F□- DK9P□BU	1200	100V 50/60Hz	2.14 21.4	2.57 25.7	3.56 35.6	4.28 42.8	5.35 53.5	6.42 64.2	7.13 71.3	8.02 80.2	9.62 96.2	11.55 115.5	12.83 128.3	14.43 144.3	17.32 173.2	20.79 207.9	23.09 230.9	28.87 288.7	30	30	30	30	30	30
110V/115V 60Hz	2.67 26.7			3.21 32.1	4.46 44.6	5.35 53.5	6.68 66.8	8.02 80.2	8.91 89.1	10.02 100.2	12.03 120.3	14.43 144.3	16.04 160.4	18.04 180.4	21.65 216.5	25.98 259.8	28.87 288.7	30	30	30	30	30	30	30	30	30
90	100V 50/60Hz		0.80 8.0	0.96 9.6	1.34 13.4	1.60 16.0	2.00 20.0	2.41 24.1	2.67 26.7	3.01 30.1	3.61 36.1	4.33 43.3	4.81 48.1	5.41 54.1	6.50 65.0	7.79 77.9	8.66 86.6	10.83 108.3	12.99 129.9	14.61 146.1	17.54 175.4	19.49 194.9	23.38 233.8	29.23 292.3	30	30
	110V/115V 60Hz		0.92 9.2	1.11 11.1	1.54 15.4	1.85 18.5	2.31 23.1	2.77 27.7	3.08 30.8	3.46 34.6	4.16 41.6	4.99 49.9	5.54 55.4	6.23 62.3	7.48 74.8	8.98 89.8	9.97 99.7	12.47 124.7	14.96 149.6	16.83 168.3	20.19 201.9	22.44 224.4	26.93 269.3	30	30	

● Single-phase 200V/240V

unit = above : N·m / below : kgf·cm

Model Motor/Gearhead	Ratio Speed(rpm)	3	3.6	5	6	7.5	9	10	12.5	15	18	20	25	30	36	40	50	60	75	90	100	120	150	180	200	
		K9R□180F□- DK9P□BU	1200	200V/220V 50Hz/60Hz	2.14 21.4	2.57 25.7	3.56 35.6	4.28 42.8	5.35 53.5	6.42 64.2	7.13 71.3	8.02 80.2	9.62 96.2	11.55 115.5	12.83 128.3	14.43 144.3	17.32 173.2	20.79 207.9	23.09 230.9	28.87 288.7	30	30	30	30	30	30
230V 50Hz/60Hz 240V/50Hz	2.31 23.1			2.77 27.7	3.85 38.5	4.62 46.2	5.77 57.7	6.93 69.3	7.70 77.0	8.66 86.6	10.39 103.9	12.47 124.7	13.85 138.5	15.58 155.8	18.70 187.0	22.44 224.4	24.93 249.3	30	30	30	30	30	30	30	30	30
90	200V/220V 50Hz/60Hz		0.73 7.3	0.87 8.7	1.22 12.2	1.46 14.6	1.82 18.2	2.19 21.9	2.43 24.3	2.73 27.3	3.28 32.8	3.94 39.4	4.37 43.7	4.92 49.2	5.90 59.0	7.09 70.9	7.87 78.7	9.84 98.4	11.81 118.1	13.29 132.9	15.94 159.4	17.71 177.1	21.26 212.6	26.57 265.7	30	30
	230V 50Hz/60Hz 240V/50Hz		0.78 7.8	0.93 9.3	1.30 13.0	1.56 15.6	1.94 19.4	2.33 23.3	2.59 25.9	2.92 29.2	3.50 35.0	4.20 42.0	4.67 46.7	5.25 52.5	6.30 63.0	7.56 75.6	8.40 84.0	10.50 105.0	12.60 126.0	14.17 141.7	17.01 170.1	18.90 189.0	22.67 226.7	28.34 283.4	30	30

- * Gearhead and decimal gearhead are sold separately.
- * The code in □ of gearhead model is for gear ratio.
- * ■ color indicates that the output shaft of the geared motor rotates in the same direction as the output shaft of the motor. Others indicate rotation in the opposite direction.
- * If you are to have less ratio than the ratio in the table, you can install the decimal gearhead, which has one tenth of the ratio, between the gearhead and the motor. In this case, the permissible torque is 3N·m/30kgf·cm.
- * RPM is based on motor's synchronous rpm (50HZ:1500rpm, 60HZ:1800rpm) and calculated by dividing gear ratio. Actual rpm is 2~20% less than indicating rpm according to load size.

GEARHEAD

CONNECTION DIAGRAMS

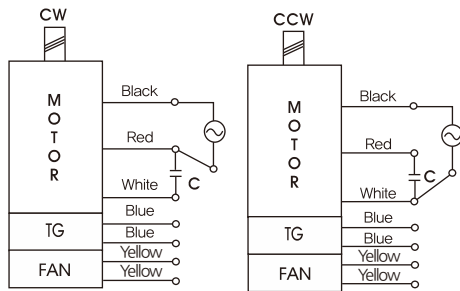

※The direction of motor rotation is as viewed from the front shaft end of the motor

DIMENSIONS

K9P□BU

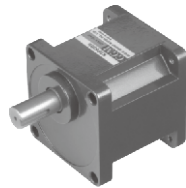

K9P□BUF

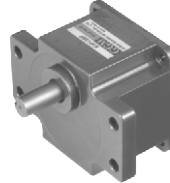

DECIMAL GEARHEAD

K9P10BX

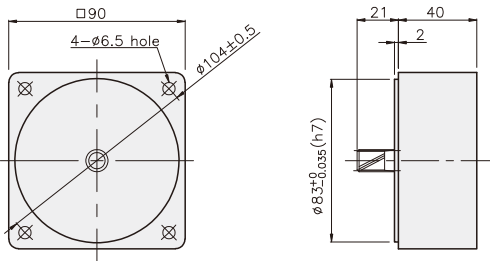

KEY SPEC

● KEY

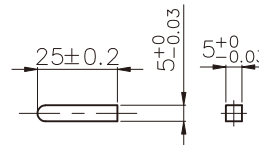

● KEY GROOVE

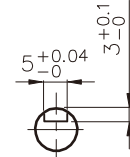

GEARHEAD

K9P□BU

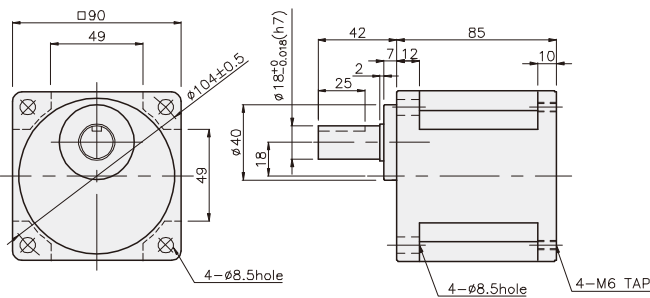

K9P□BUF

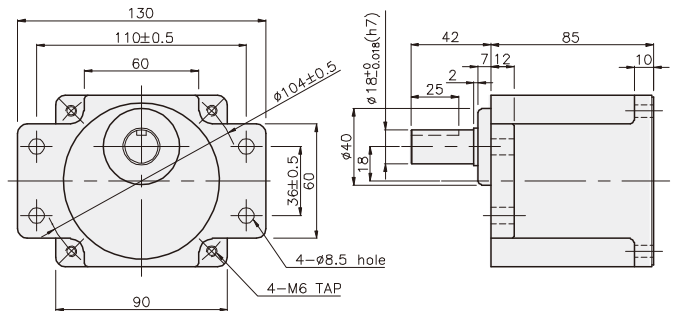

GEARHEAD

DIMENSIONS

K9RP180F□-SU + K9P□BU

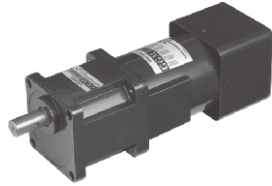

K9RP180F□-SU + K9P□BUF

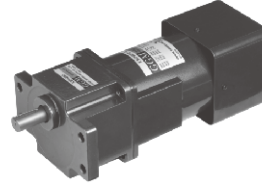

WEIGHT

PART	WEIGHT(kg)
MOTOR	4.24
DECIMAL GEARHEAD	0.62

DIMENSION TABLE

PART No.	Application Model	Mounting BOLT
01	K9P3~200BU	M6 P1.0 × 20
02	K9P10BX	M6 P1.0 × 65

WEIGHT

PART	WEIGHT(kg)
K9P3~10BU	1.44
K9P12.5~20BU	1.55
K9P25~60BU	1.69
K9P75~200BU	1.74

DIMENSION TABLE

PART No.	Application Model	Mounting BOLT
01	K9P3~200BUF	M6 P1.0 × 20
02	K9P10BX	M6 P1.0 × 65

WEIGHT

PART	WEIGHT(kg)
K9P3~10BUF	1.50
K9P12.5~20BUF	1.62
K9P25~60BUF	1.76
K9P75~200BUF	1.82

K9RP180F□-SU + K9P□BU

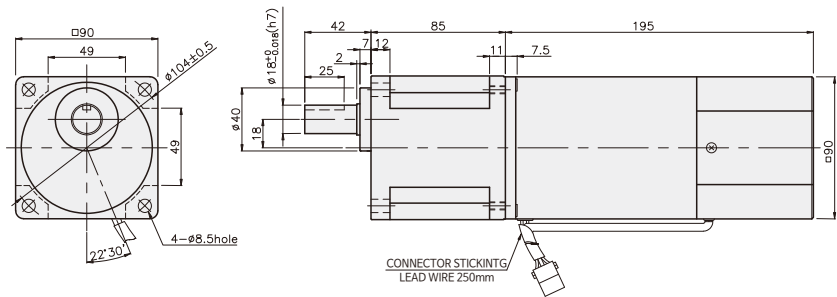

K9RP180F□-SU + K9P□BUF

