

Stepper drives
Servostep drives
Controllers & HMI



eePLC Studio™



2015

Ever
ELETTRONICA
the clever drive

Performance and quality of products and services



"The clever drive" stands for Ever Elettronica's key design concepts, resulting from more than thirty years of experience in **intelligent drives** developments based on innovative **full digital** hardware and software technologies for **synchronous brushless motors with a high number of poles**, commonly known as **stepper motors**. Normally used in **open loop**, these motors can also substitute servomotors with a low number of poles in **closed loop** applications, against less cost, an improved easiness of use and without mechanical gear on the shaft; the reduced dimensions, the good rotor inertia and the high torque already starting from zero speed with vector sinusoidal phase excitation, increase the stepper motor performances particularly in terms of dynamics and positioning precision in applications with direct coupling to the load.



"The Clever Drive" is based on an **innovative f⁴d²** (Fast Forward Feed Full Digital Drive) **technology** which, thanks to the velocity of the current regulating calculations, executed by the drive's DSPC by means of a Ever Elettronica patented innovative algorithm, enables the motor excitation at a high chopper frequency and with sinusoidal phase currents without parasitic harmonics, obtaining in this way a silent and smooth rotor rotation without resonances, a maximum torque at every speed and a high drive efficiency. Also the **servostep drives** with which Ever Elettronica extended the stepper motor control from the traditional micro-step control in open loop to **step-less motor control**, synchronous sinusoidal excitation, unlike micro-step control which doesn't exclude step synchronism loss.



The drives with **full digital f⁴d²** technology in **open loop control and servostep technology in closed loop control of torque, velocity and position** are constituted as high-end **vector sinusoidal** drives which can replace AC brushless systems, performing at the same level and against definitely reduced costs, by taking full advantage of the dynamic features and positioning precision of the stepper motors in applications. **AC or DC power supply, optoisolated** inputs, outputs and fieldbus interfaces, extended and effective **protections**, full compliance with regulations and **product standards**, a **reduced** number of **hardware** components, **low overheating** also when used for high power applications, mechanical robustness of the motor and a high working temperature of the feedback elements, are the features which ensure an adequate reliability of the Ever Elettronica drives and motors, also under the heaviest working conditions.



Extended drive lines which, thanks to a fast phase current control by the f⁴d² firmware, with a single DSPC can manage at the same time the motor control and **a series of complementary functions** which Ever Elettronica have developed over the years, especially ready-to-use **intelligent motion control modules, IDE for the drive programming and software to control** the drives by means of fieldbus and to monitor the drive's working status. These functions are available to the user in the form of drive models which are **specified on base of their intelligence level and programmability**, housing, power supply type, number of I/O and communication interfaces. Additionally, to simplify the switchboard and electrical wiring, there are available **integrated drives with motor, drive and feedback encoder**, characterized by a minimal thermal dissipation also when used at maximal power, mechanical robustness and an appropriate reliability of use, also under heavy working conditions regarding vibrations and temperature.



Specific machine control solutions for various industrial sectors have been implemented by using Ever Elettronica drives of the full digital line in open or closed loop, working in "master-slave" as well as in "standalone" mode by means of the in the drive integrated PLC function due to the limited machine time fraction dedicated by the drive's DSPC with f⁴d² firmware to control the motor. Completed with **controllers, gateways and HMI interfaces**, these application solutions are flexible, complete and easy to configure for particular situations of use and can also constitute a solid starting basis for the development of new customized solutions for specific client needs.



A **reliable service package** is offered to our clients that do not just find a new supplier when working with Ever Elettronica, but a complete and reliable partner with an additional design department widely experienced in automation, to support their technical structure.



A **price adapted to the daily needs of automated production machinery manufacturers**, is feasible thanks to the completeness of the optimized hardware and software solutions and the reduction of waste generated during the devices production and thus minimize material costs without diminishing the performances, robustness, security and reliability of use.

f⁴d² technology for optimized motor control in open and closed loop

The **f⁴d² technology** (Fast Forward Feed Full Digital Drive) obtains, thanks to the sinusoidal regulation free of parasitic harmonics and a high chopper frequency of the phase current, a silent motor rotation from the drive without resonances, a maximum torque at every speed and high efficiency.

With the servo step drives developed for servo performances, Ever Elettronica have extended the motor control from the traditional micro-step control in open loop to stepless control with synchronous sinusoidal excitation of the motor phases, unlike the micro-step control that doesn't exclude step synchronism loss, even in presence of fast motor accelerations. The servostep system is realized with a motor feedback system with an incremental encoder with a resolution depending on the dynamic accuracy required by the application.

Normally it's also possible to obtain performances equivalent to brushless systems performances with inexpensive low-resolution encoders (400 ppr), which can simulate the functioning of a stepper motor only in combination with a high resolution encoder. In the servostep systems the encoder feedback doesn't simply exist of recognizing the occurring step loss during or at the end of the motor movement, but guarantees the continuous rotor movement synchronism. The stepless phase excitation, characterizing the servostep systems with an optimized excitation angle to reach a higher velocity and step resolution than when using the micro-step technology, avoids resonances due to the motor structure and rotor oscillations near the final position.

Moreover, it maximizes the torque generated by the motor to vary the speed and reaction capacity instantly to load changes obtaining excellent dynamic performances even in presence of almost purely inertial loads and without the need for mechanical resonance researches (FFT) and module and phase analysis executed for the brushless drives.

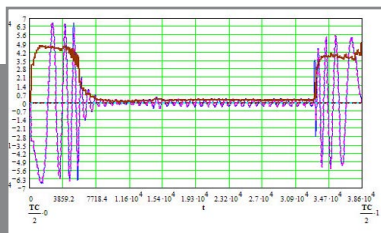
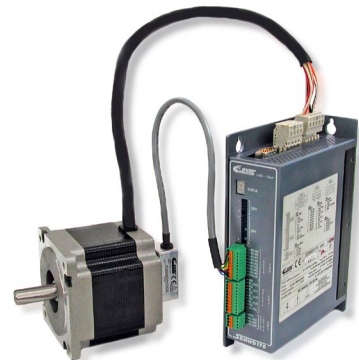

TEMPO IN MICROSECONDI

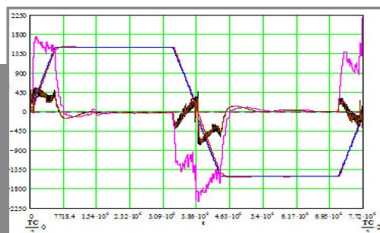

TEMPO IN MICROSECONDI

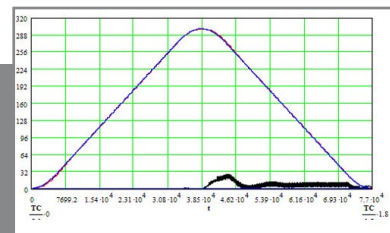

TEMPO IN MICROSECONDI

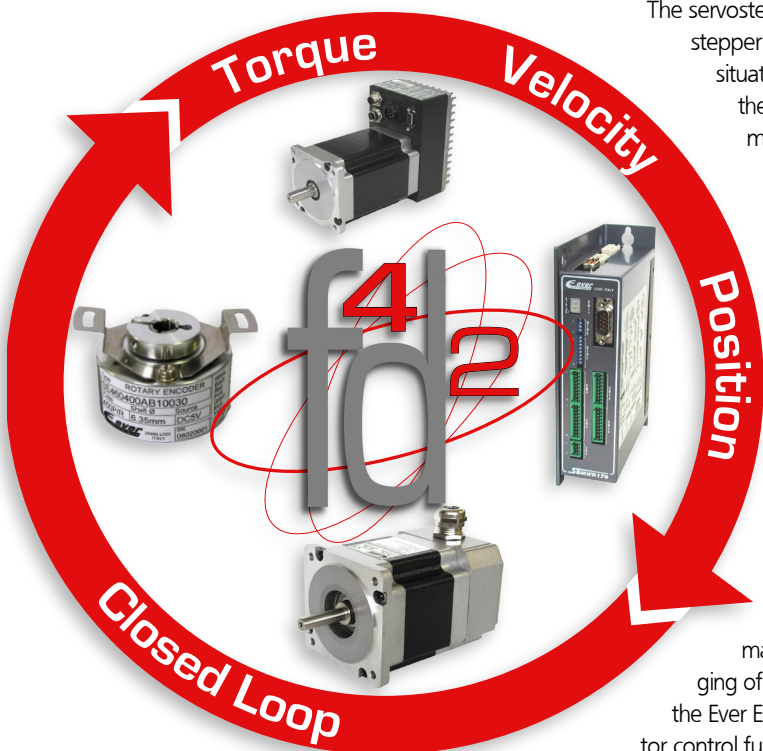

The servostep drives avoid the oversizing occurring in open loop stepper systems to ensure the correct functioning in all load situations. They are capable to quickly reach and stabilize the desired positioning reference tracking value in movements with a direct coupling to the load until a speed of 2000 rpm, replacing drives with a brushless motor to diminish costs in applications of which the resonance frequency varies depending on the load variation applied to the motor, which makes application parameterization through automated learning systems impossible.

All feedback management adjustments to the programmable drives in open loop and servostep are made by means of RS232 or RS485 serial interfaces or by CANbus or profibus fieldbus connection, depending on the used drive version. Through these interfaces it's possible to configure the control parameters of the drive and feedback loop by means of special software, to execute the application settings with real time scope monitor and to manage by means of IDE the programming and debugging of user applications managed by the firmware of which the Ever Elettronica drives are equipped additionally to the motor control functions in open and closed loop.

Full digital drives with additional extended functionality (PLC)

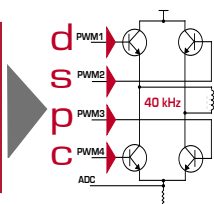

In the digital f⁴d² (Fast Forward Feed Full Digital Drive) drives of the SlimLine, SD Enhanced and integrated SM series, the power stages that supply the current to the motor are controlled in PWM mode, managed by an innovative firmware owned and patented by Ever Elettronica, and a DSPC (Digital Signal Processor Controller) that replaces the microprocessor which is generally used in the traditional drives with mixed digital-analogue technology. Thanks to the calculation speed of the f4d2 technology for the current regulation, the drives can realize sophisticated

power supply modes with phase excitation at a high chopper frequency and with sinusoidal currents free of parasitic harmonics and a silent and smooth rotor rotation without resonances, a maximum torque at every speed and high drive efficiency. As a minimal number of hardware components are used, the drives offer a higher simplicity and reliability. Thanks to the f4d2 technology, a single microprocessor is able to manage a series of useful complementary features simultaneously with the motor control, in particular objects for the motion and machines control and solutions based on the typicals Plc functionality integrated in the drives, taking advantage of the small fraction of machine time dedicated to the motor control.

An extremely flexible motor control is reached thanks to an optimized phase current regulation by means of software for the management of different motion situations to obtain a sinusoidal regulation without parasitic harmonics and a high chopper frequency in micro step mode in open loop and an always synchronous stepless mode in closed loop.

Optimized quality, dimensions and costs are obtained by applying particularly robust, compact and surface mounted solutions, based on full digital technology and having a reduced number of hardware components being equipped with extended hardware protections. The solutions are designed and produced in accordance with the directions for hardware and software products and regulations for security of use.

Long-term Reliable and stable performances are obtained thanks to the completely digital electronics, the DC or AC power supply, the optoisolated fieldbus interfaces, and extended optoisolated control range input and output lines (5 ÷ 24 Vcc line driver, PNP, NPN) to simplify the installation.

The drives with f⁴d² technology used for open loop control and the servostep drives used for closed loop control of torque, velocity and position, are configured as high-end sinusoidal vector drives making use of the dynamic features and positioning precision of the stepper motors and improving the qualitative and functional features of the traditional drives, offering the user versatility, an easier installation and a better devices management.

Silent and smooth motor rotation even at lower speeds, thanks to the precise sinusoidal regulation without harmonics and a high chopper frequency (40 kHz) of the winding current in micro-step mode in open loop control and in permanently synchronous stepless mode in closed loop control.

Maximal power efficiency and less overheating of the motor and the drive, at motor stand still and when rotating thanks to the excitation algorithms of the windings which are optimized to reach a maximal torque and a high efficiency at every speed, with synchronous rectification of the power stages.

Extended complementary features, managed by a single DSPC simultaneously with the motor control, including ready-to-use intelligent motion control modules and complete applications available to the user by means of drive models that differ from each other on the field of intelligence level, programmability, housing, power supply, number of I/Os and communication interfaces. Moreover, to simplify the electrical switchboards and wiring, there are available integrated drive systems with motor, drive and feedback encoder.

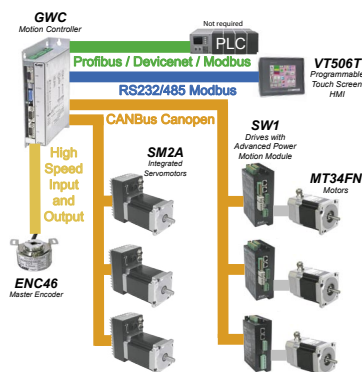

Specific and flexible Machine control solutions, easily configurable for particular situations of use in various industrial sectors, are available to the user thanks to the PLC functionality integrated in the drives, working in open as well as in closed loop, and in "master-slave" and "standalone" mode. Offering a complete functioning and being equipped with controllers, gateways and HMI interfaces, these solutions can also constitute a solid starting base for the development of new customized solutions for specific client needs thanks to the support and services offered by Ever Elettronica.

Machine control solutions dedicated to industries

The product range offered by Ever Elettronica includes complete hardware and software packages, with an open architecture, offered to various industrial automation sectors, such as: packaging, labelling, mechano-textile, food industry, medical, ceramic machinery, printing, office automation, video surveillance, machine tools, robotics, etc.

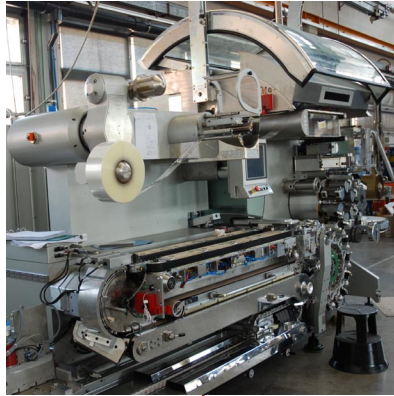

Thanks to the experience acquired over the years and the ability to supply proven or customized solutions on base of specific client needs, Ever Elettronica is able to offer a real competitive advantage to its clients.



The high reliable, versatile and ready-to-use solution packages of Ever Elettronica, for use in open and closed loop applications, are equipped with configuration software and IDE realized to ensure a fast and easy installation set up of the client's application.

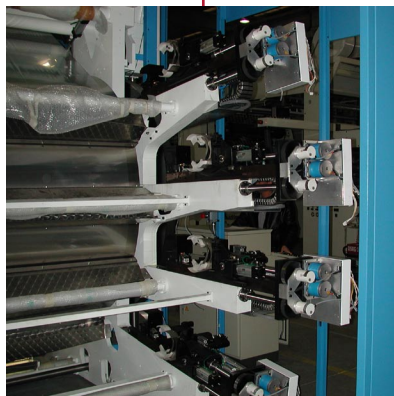

On base of their long experience in determining the real needs of the automation market and knowledge about the time and costs an automatic machines builder normally dedicates to the development of its solutions, Ever Elettronica realized a wide range of control solutions for the control of automated machines in various industrial sectors.

Drives for all applications

TITANIO VECTOR · STEPPER · DRIVES

Titanio Drives (ELSE technology: Error-Less-Servo-Efficient)

LW3 drivers of Titanio series, based on Arm Core M4 technology, implement the vectorial control of 2-3 phases stepper motors. "Else" technology allows a smooth movement together with a positioning accuracy and a noiseless rotation never seen before for a stepper driver.



SlimLine Drives

Easy-to-use and versatile Smart-Light-Integration-Motion drives line. The *Full Digital technology* series are developed to meet the growing demand for high qualitative and fair priced drives, and are characterized by a basic but complete set of drives engineered with the objective to reach the best quality against restrained production costs.

The line is divided in **LW Hardware controlled** and **SW Software controlled** electronics: to the first category belong all *Low End* models controlled by means of digital Step & Direction signals of a master unit (PLC); the second category includes all *High End* models configurable through software by the user to function in fieldbus networks or programmables by means of eePLC software, an IDE to execute controls in standalone mode and PLC functions.



SD Enhanced Drives

The **SD** electronics family is a high performance *Full Digital* drives series, with advanced functionalities for micro-step control of the motor in open loop and stepless mode control in **closed loop of torque, velocity and position**, controlling the motor as a servomotor (servo step). The SD series groups **f4d² technology** (Fast Forward Feed Full Digital Drive) devices equipped with firmware designed to suit every control situation as follows: drives controlled by means of digital or analogue clock & direction signals from a master unit, drives controlled through CANbus fieldbus, profibus or serial interface, drives able to execute standard or customized applications in 'standalone' mode, making use of MS Windows PC software environments to configure the working parameters and drives that are free programmable by the user by means of ATOMIC IDE.



Integrated SM drives

The **SM** line includes a series of devices based on **f4d² technology** (Fast Forward Feed Full Digital Drive) integrating motor, intelligent drive and, in the closed loop version with typical servomotor performances in **closed loop of torque, velocity and position** an incremental or absolute feedback encoder. The line is designed to simplify electrical switchboards and wiring in single or multi axes installations through devices characterized by a minimal heat dissipation adapted for use at maximal power, and offering mechanical robustness and reliability of use also under heavy working conditions regarding vibrations and temperature. The SM series is composed of devices equipped with firmware designed for CANbus fieldbus control, profibus or serial interface control, able to work in 'standalone' mode in standard or customized applications. The drives are configurable through the working parameters by means of MS Windows PC software or free programmable by the user by means of ATOMIC IDE.



Functionalities available

Clock & Direction Drives with analogue velocity reference

Micro-step controlled in open loop and stepless controlled in closed loop of torque, velocity and position with the ability to manage the acceleration and deceleration ramps and to control the motor.

Drives for Fieldbus control

Micro-step controlled in open loop and stepless controlled in closed loop of torque, velocity and position with CANBus Slave (Canopen DS301 / DS402), Profibus Slave(Profibus-DP) or Serial Slave (Modbus-RTU) interface with Advanced Power Motion Module and firmwares configurable through the working parameters by means of MS Windows PC software development environments in single or multi axles systems.

Programmable drives

Micro-step controlled in open loop and stepless controlled in closed loop of torque, velocity and position equipped with PLC functionalities able to work in standard or customized 'standalone' applications and free programmable by the user by means of IDE software in single or multi axles applications.

Special and Custom Drives "Open Frame" Drives for the integration with the machine's electronics.

HMI

Programmables Human Machine Interfaces in alphanumeric and touch screen version for an easy application control and data input.

Controllers - Gateways

All in one devices equipped with Motion Controller, Gateway for the communication between different fieldbusses and PLC for the programming and management of applications.



error less servo efficient
else technology
 by Ever Elettronica

TITANIO
 VECTOR · STEPPER · DRIVES

Titanio drives

Main features:

- ✓ sensorless motor stall detection
- ✓ integrated diagnostic
- ✓ protections against short circuit motor, open phases, over/under voltage and temperature
- ✓ Vectorial control: the sinusoidal phase current with 'Else' technology keep the motor torque constant allowing smooth and noiseless movements.

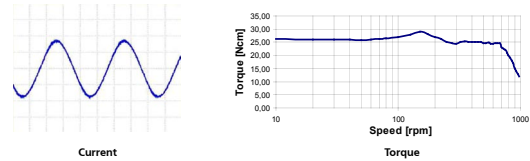

Description:

LW3 are the new vectorial drivers series belonging to the Titanio series characterized by innovative performances. Built with the new "Else - Error Less Servo Efficient" technology with a precise sinusoidal current control, these drivers allow you to control stepper motors with a decisive noise reduction, less motor heating and a very smooth movement.

Suitable for the control of 2-3 phases hybrid stepper motors, they can be coupled mainly with motors' series from 0.8" to 3.4".

Full digital and realized with Arm Core M4 technology, LW3 drivers offer exceptional reliability together with compact size and competitive price.

They can be used in many different machine types where there is already a controller for the clock&dir signals generation, such as X-Y tables, labelling machines, laser cutting machines, pick&place devices, cutting boards, etc... and are in each case indicated in all the applications where versatility, accuracy and speed but also noiseless and smooth movements are requested (ex. medical sector).

- ✓ motor stall detection without encoder
- ✓ smooth movement
- ✓ compact size
- ✓ noiseless rotation
- ✓ reliability
- ✓ low EM emissions
- ✓ software resonance damping
- ✓ auto tuning of motor control parameters
- ✓ high efficiency current set up
- ✓ reduction of motor temperature
- ✓ digital IN 2 ÷ 24 Vdc

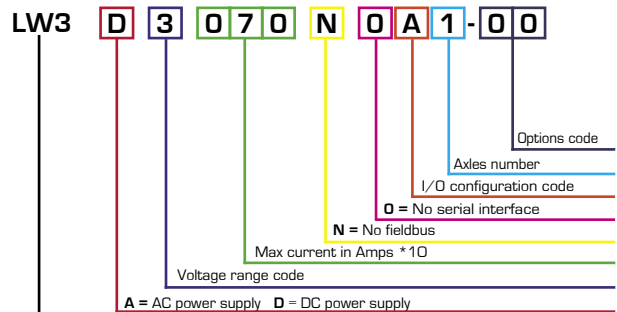

LW3= Vectorial drives hardware controlled Titanio series

Order code		Power		Digital inputs
Versions	Power supply	Auxiliary output	Current	
3024 Models				
LW3D3032N0A1-00	24 ÷ 80 Vdc	---	0.21 ÷ 3.2 Arms (0.3 ÷ 4.5 Apeak)	4 optoisolated 2 - 24Vdc 2 MHz compatible NPN or PNP or Line Driver
3070 Models				
LW3D3070N0A1-00	24 ÷ 80 Vdc	---	1.70 ÷ 7.1 Arms (2.4 ÷ 10.0 Apeak)	4 optoisolated 2 - 24Vdc 2 MHz compatible NPN or PNP or Line Driver

Specifications:

Optically isolated inputs: 4 digitals 2-24 Vdc NPN, PNP or Line Driver (2 MHz).
Optically isolated output: 1 digital 24 Vdc – 100 mA for driver's status monitoring.
Step resolution: from full step up to 1/256 emulated.
Safety Protection: Over/Under Voltage, Over Current, Over Temperature, Short circuit Phase/Phase and Phase/Ground.
Drive Status Monitoring: 3 leds with guiding light (green and red/yellow).
Temperature: working: from 0°C to 40°C, storage: from -25°C to 55°C.
Humidity: 5% ÷ 85%.
Protection Class: IP20.

Control modalities:

clock & direction: • Setting of the current value by means of dip-switches.

- Selection of the step angle by means of roto-switches. In order to maintain compatibility with traditional drivers, step angles have been emulated through software, the current regulation is always sinusoidal.

• Possibility to select five user functions:

- 1 - Enabling of motor stall detection. Reading the motor BEMF, LW3 drivers detect without encoder the step loss, showing alarm status with the Fault digital OUT and a LED sequence.
- 2 - Step/Direction or Clock-Up / Clock-Down control mode.
- 3 - Enable input management (safety control).
- 4 - 30% or 70% automatic current reduction (still motor).
- 5 - Enabling of "Clock Test" function, useful during the driver's installation, which shows the right presence of the clock signal through status LED flashing.

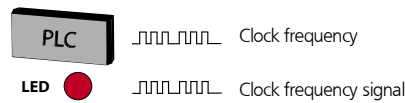
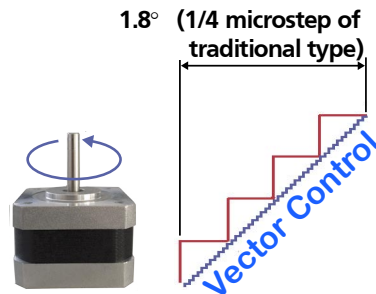
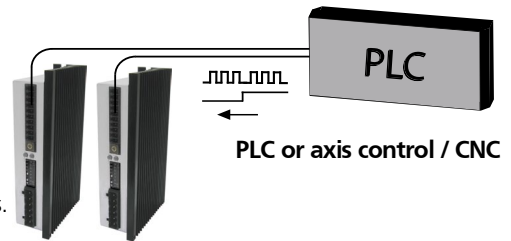

System resources			Mechanical data
Analog inputs	Digital outputs	Dimensions HxWxD	Weight
---	1 optoisolated 24 Vdc 100 mA PNP for FAULT	128.0x30.0x74.0 mm	290 gr.
---	1 optoisolated 24 Vdc 100 mA PNP for FAULT	128.0x30.0x74.0 mm	290 gr.



SlimLine drives

Main features:

- Equipped with advanced safety devices:
 - ✓ tested for direct unit installation
 - ✓ failures monitoring and handling
- Main advantages of the drives:
 - ✓ low motor vibrations
 - ✓ low mechanical noise
 - ✓ low heat production
 - ✓ excellent EMC properties
 - ✓ safety protections
 - ✓ AC/DC power supply
 - ✓ compact dimensions
 - ✓ no motor resonance
 - ✓ high reliability
 - ✓ easy to set-up
 - ✓ high speed and torque drive
 - ✓ wide power range

Description:

The LW1 are a series of high performance micro stepping drives based on precise PWM sinusoidal current control technology. Thanks to this solution LW1 drives are able to command the stepper motors with lower noise, lower temperature rise and uniform movements, resulting into higher performances and speed than most of drives available on the market. The series have a wide power range and are designed for controlling 2 and 4 phase hybrid stepper motors from 1.7" to 4.2" NEMA sizes.

As the competitively priced LW1 drives are full digital and realised with surface assembly technology, they offer an extraordinary reliability and mechanical compactness.

They can be used in many types of machines, such as X-Y tables, labelling systems, laser cutting systems, pick-place devices, punching tables, etc., and in all the applications where versatility, precision, velocity and low temperatures are required as well.

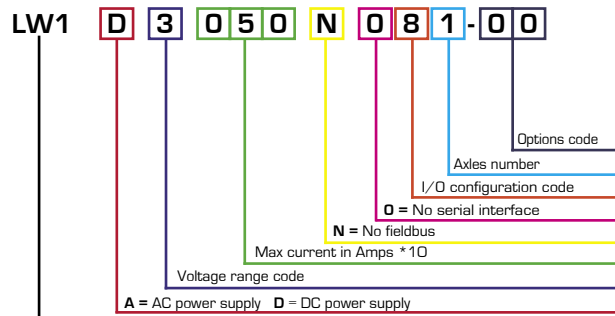

LW1= Wall mounting hardware controlled drives

Order code		Power		
Versions	Power supply	Auxiliary output	Current	Digital inputs
2014 Models				
LW1D2014N081-00	24 ÷ 40 Vdc	---	0.5 ÷ 1.4 Arms (0.7 ÷ 2.0 Apeak)	3 optoisolated 5Vdc 300 kHz NPN or PNP or Line Driver
2042 Models				
LW1D2042N081-00	24 ÷ 40 Vdc	---	1.5 ÷ 4.2 Arms (2.1 ÷ 6.0 Apeak)	3 optoisolated 5Vdc 300 kHz NPN or PNP or Line Driver
3050 Models				
LW1D3050N081-00	24 ÷ 80 Vdc	---	1.0 ÷ 5.5 Arms (1.4 ÷ 7.8 Apeak)	3 optoisolated 5Vdc 300 kHz NPN or PNP or Line Driver
LW1D3050N081-01	24 ÷ 80 Vdc	---	1.0 ÷ 5.5 Arms (1.4 ÷ 7.8 Apeak)	3 optoisolated 24Vdc 300 kHz NPN or PNP or Line Driver
LW1A3050N081-00	18 ÷ 56 Vac	24 Vcc - 3 Amps	1.0 ÷ 5.5 Arms (1.4 ÷ 7.8 Apeak)	3 optoisolated 5Vdc 300 kHz NPN or PNP or Line Driver
4085 Models				
LW1D4085N0A1-00	24 ÷ 140 Vdc	---	1.5 ÷ 8.5 Arms (2.1 ÷ 12.0 Apeak)	4 optoisolated 2 ÷ 5Vdc 300 kHz NPN or PNP or Line Driver
LW1D4085N0A1-01	24 ÷ 140 Vdc	---	1.5 ÷ 8.5 Arms (2.1 ÷ 12.0 Apeak)	4 optoisolated 11 ÷ 24Vdc 300 kHz NPN or PNP or Line Driver
LW1A4085N0A1-00	17 ÷ 100 Vac	---	1.5 ÷ 8.5 Arms (2.1 ÷ 12.0 Apeak)	4 optoisolated 2 ÷ 5Vdc 300 kHz NPN or PNP or Line Driver
LW1A4085N0A1-01	17 ÷ 100 Vac	---	1.5 ÷ 8.5 Arms (2.1 ÷ 12.0 Apeak)	4 optoisolated 11 ÷ 24Vdc 300 kHz NPN or PNP or Line Driver
9060 Models				
LW1A9060N081-00	115 ÷ 230 Vac	---	1.0 ÷ 6.0 Arms (1.4 ÷ 8.4 Apeak)	3 optoisolated 5Vdc 300 kHz Line Driver or 24 Vdc PNP

Specifications:

Power Stage: 40 kHz bipolar chopper H-Bridge.

Optically isolated inputs: 3 digital inputs, 5 Vdc NPN, PNP or line-driver (300 kHz).

Optically isolated output: 1 digital output, 24 Vdc – 100 mA for driver's status monitoring.

Step Resolution: full step to 1/256 or 1/250.

Safety Protection: Over/Under Voltage, Over Current, Over Temperature, Short circuit Phase/Phase and Phase/Ground.

Drive Status Monitoring: power LED and failure status LED.

Temperature: working temp. 0°C+50°C, storage temp. 0°C+55°C

Humidity: 0%+90%.

Protection Class: IP20.

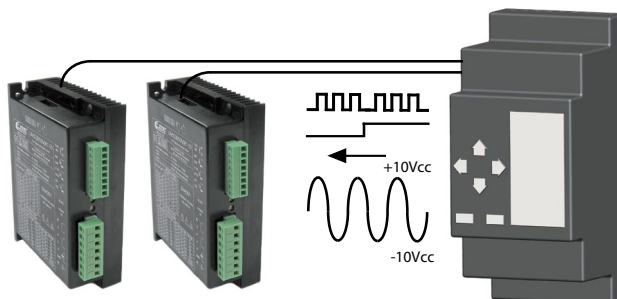

Control modalities:

- clock & direction:**
- Setting of the current value by means of dip-switches (roto-switches for 9060 models)
 - Selection of the step angle by means of dip-switches (roto-switches for 9060 models)
 - Enabling of automatic current reduction
 - Possibility to select five user functions by means of jumpers settings (2042 models) or dip-switches (3050 and 4080 models) or roto-switches (9060 models) choosing:
 - 1 - Active edge of step and direction inputs
 - 2 - Step / Direction or Clock-Up / Clock-Down control mode
 - 3 - Drive enable input functioning:
 - a) the motor is powered if the enable input is open
 - b) the motor is powered if the enable input is closed
 - 4 - 'Voltage mode' functioning: when the motor rotation speed exceeds 400 rpm, the drive switches automatically to full step to compensate the efficiency and torque loss due to current auto-limitation when the rotation speed increases
 - 5 - Maximum current range for precise setting of the desired value

System resources			Mechanical data
Analog inputs	Digital outputs	Dimensions HxWxD	Weight
---	1 optoisolated 24 Vdc 100 mA transistor output for Fault	100.0x74.0x37.0 mm	250 g.
---	1 optoisolated 24 Vdc 100 mA transistor output for Fault	100.0x74.0x37.0 mm	250 g.
---	1 optoisolated 24 Vdc 100 mA transistor output for Fault	120.0x97.0x45.5 mm	500 g.
---	1 optoisolated 24 Vdc 100 mA transistor output for Fault	120.0x97.0x45.5 mm	500 g.
---	1 optoisolated 24 Vdc 100 mA transistor output for Fault	120.0x97.5x62.3 mm	610 g.
---	1 optoisolated 24 Vdc 100 mA transistor output for Fault	165.0x108.0x49.0 mm	680 g.
---	1 optoisolated 24 Vdc 100 mA transistor output for Fault	165.0x108.0x49.0 mm	680 g.
---	1 optoisolated 24 Vdc 100 mA transistor output for Fault	165.0x108.0x49.0 mm	780 g.
---	1 optoisolated 24 Vdc 100 mA transistor output for Fault	165.0x108.0x49.0 mm	780 g.
---	1 optoisolated 24 Vdc 100 mA transistor output for Fault	235.0x151.5x62.5 mm	1350 g.



Description:

The SDL drive series are Full Digital high performance micro-step devices based on the precise pwm control technology to regulate the sinusoidal current. Thanks to this solution the SDL drives are able to control stepper motors through digital step, direction, rating and starting current signals with less noise, less heating and smooth motion in open as well as **in closed loop of torque, velocity and position**. Designed for the control of 2 or 4 phase hybrid stepper motors, a wide range of stepper drives with a different power level are available to be used with motor series from 1.7" to 4.2". The SDL drives offer reliability and first-class performances and can be used in many types of machines such as X-Y-Z tables, laser cutting systems, pick & place devices, etc. They are suitable for use in applications that require a high precision, speed and easiness of use.

Main features:

- On board safety provisions:
 - ✓ fully tested for direct installation unit
 - ✓ built in watch dog functionality
 - ✓ fault monitoring and handling
 - ✓ on field working errors buffering
- Main advantages of the drives:
 - ✓ low motor vibration
 - ✓ low mechanical noise
 - ✓ low heat generation
 - ✓ closed loop of torque, velocity and position
 - ✓ energy saving
 - ✓ no resonance
 - ✓ high reliability
 - ✓ DC/AC power supply
 - ✓ wide range of power

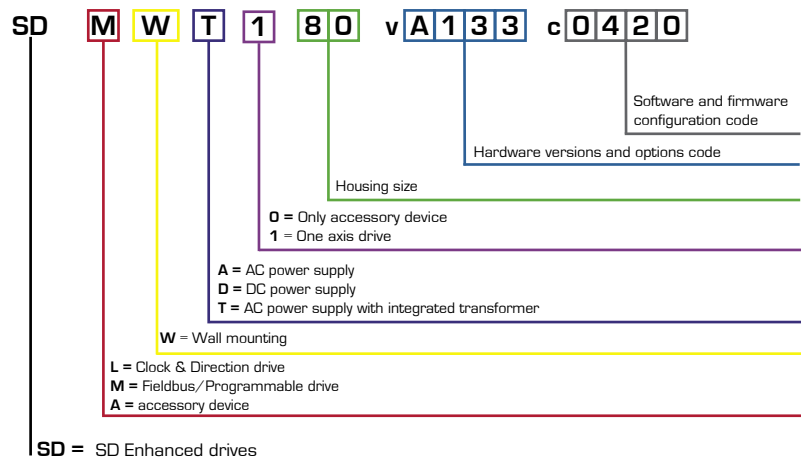

Order code		Power		Current	Digital inputs
Versions	Configurations	Power supply Logic	Power		
Modelli 170					
SDMWD170vB231	c0420	24 ÷ 140 Vdc	24 ÷ 140 Vdc	1.0 ÷ 8.0 Arms (1.4 ÷ 11.2 Apeak)	4 optoisolated 200 kHz 5Vdc line-driver or 24 Vdc PNP
SDMWA170v2231	c0420	24 ÷ 90 Vac	24 ÷ 90 Vac	1.0 ÷ 8.0 Arms (1.4 ÷ 11.2 Apeak)	4 optoisolated 200 kHz 5Vdc line-driver or 24 Vdc PNP
Modelli 180					
SDMWD180vA133	c0420	24 ÷ 70 Vdc		0.5 ÷ 5.0 Arms (0.7 ÷ 7.0 Apeak)	4 optoisolated 200 kHz 5Vdc line-driver or 24 Vdc PNP
SDMWA180vA133	c0420	24 ÷ 48 Vac		0.5 ÷ 5.0 Arms (0.7 ÷ 7.0 Apeak)	4 optoisolated 200 kHz 5Vdc line-driver or 24 Vdc PNP
SDMWT180vA133	c0420	115 ÷ 230 Vac		0.5 ÷ 5.0 Arms (0.7 ÷ 7.0 Apeak)	4 optoisolated 200 kHz 5Vdc line-driver or 24 Vdc PNP

Specifications:

Power stages: 40 kHz H-bridge Bipolar chopper.

Optically isolated inputs: up to 8 digital optoisolated inputs 5 Vdc line driver or 24 Vdc NPN or PNP(200 kHz).

Optically isolated output: 8 digital optoisolated output 24 Vdc – 100 mA (700 mA for 170 models).

Step resolution: from 1 to 128 micro steps.

Safety protections: over/under-voltage, over current, over temperature, open windings, closed windings phase/phase phase/ground.

Drive Status Monitoring: seven segments LED display.

Temperature: working temp. 0°C+50°C, storage temp. 0°C+55°C

Humidity: 0%+90%.

Protection class: IP20.

Control modalities:

digital tracker: The Digital Tracker mode enables unlike the Step & Dir mode, also the tracking of an external analog signal and the complete parameterization of the drive by means of serial RS232. Besides the drive's configuration parameters (step angle, current, internal ramp, functioning type, etc.) it's possible to activate the following features:

- set ratio between the reference speed and the motor speed (Gear Ratio);
- set min and max full scale of the analog reference (0÷10V or – 10V÷10V);
- Enabling/Disabling of the position and velocity feedback (open loop/closed loop);
- Set tracking type (clock & dir, clock & dir with internal ramps, tracking of an incremental encoder, speed tracking of an analog signal).

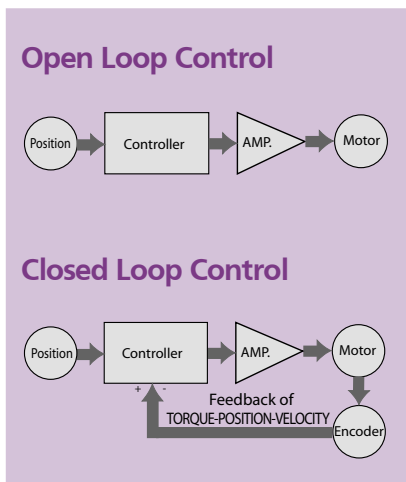

Advantages of Closed Loop Control:

- compared to an open loop stepper solution;
 - reliable positioning without synchronism loss;
 - keeping stable and automatic recovery of the original position in case of positioning errors caused by external factors such as mechanic vibrations;
 - 100% exploitation of the motor torque;
 - ability to work at high speed in relation to the current control which is regulated in accordance with the load variations, where the normal open loop systems use a constant current control at all speeds without taking into account the load variations.
- compared to a brushless servo-controlled solution;
 - no need for power regulation (automatic current regulation according to the load variations);
 - keeping stable of the position without fluctuations after the positioning completion;
 - fast positioning favoured by the independent control of the integrated DSP;
 - Continuous and fast execution of short stroke movements thanks to the short positioning time.

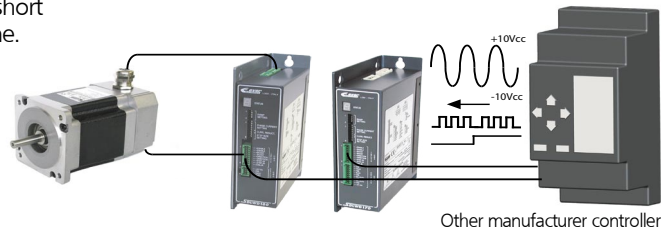

Other manufacturer controller

Risorse di Sistema

Mechanical data

Digital outputs	Analog inputs	Interface	Control	Dimensions	Weight
4 optoisolated 24 Vdc 500 mA	1 ±10 Vdc or potentiometer	Serial RS232/422/485	Digital Traker / Analog Ref. / Closed Loop	175.0x47.7x123.3 mm	770 g.
4 optoisolated 24 Vdc 500 mA	1 ±10 Vdc or potentiometer	Serial RS232/422/485	Digital Traker / Analog Ref. / Closed Loop	175.0x88.3x123.3 mm	800 g.
3 optoisolated 24 Vdc 100 mA transistor output	2 ±10 Vdc or potentiometer	Serial RS232/422/485	Digital Traker / Analog Ref. / Closed Loop	175.0x47.7x123.3 mm	680 g.
3 optoisolated 24 Vdc 100 mA transistor output	2 ±10 Vdc or potentiometer	Serial RS232/422/485	Digital Traker / Analog Ref. / Closed Loop	175.0x47.7x123.3 mm	810 g.
3 optoisolated 24 Vdc 100 mA transistor output	2 ±10 Vdc or potentiometer	Serial RS232/422/485	Digital Traker / Analog Ref. / Closed Loop	175.0x118.0x124.3 mm	1500 g.



SlimLine drives



Description:

The SW are a drives series with local logic which can be connected in slave mode to single or multi-axes systems through a CANBus (Canopen DS301/DS402), Profibus (Profibus-DP) or serial (Modbus-RTU) connection. Many control modes with advanced functionalities can be applied thanks to the integral Power Motion Module and the availability of high speed inputs and outputs. The application set-up and debugging take place by configuring all parameters through software, making use of the software interface for PC Windows named SL-Monitor.

A wide range of stepper drives of different power levels, designed to control 2 or 4 phase hybrid stepper motors, are available to combine with motor series ranging from 1.7" to 4.2". The Full digital and competitively priced SW1 drives, realized with surface mounting technology, offer reliability and mechanical compactness. The drives are suitable for applications that require axes synchronization, versatility, accuracy, a high execution speed and low operating temperatures.

Main features:

- Multiform control modes
- On Board Safety provisions:
 - ✓ fully tested for direct installation unit
 - ✓ built in watch dog functionality
 - ✓ fault monitoring and handling
 - ✓ separated power supply for logic and power
 - ✓ on field working errors buffering
- Main advantages of the drives:
 - ✓ low motor vibration
 - ✓ low mech. noise
 - ✓ no resonance
 - ✓ safe protections
 - ✓ DC/AC power supply
 - ✓ compact size
 - ✓ low heat generation
 - ✓ high reliability
 - ✓ high speed and torque
 - ✓ wide range of power

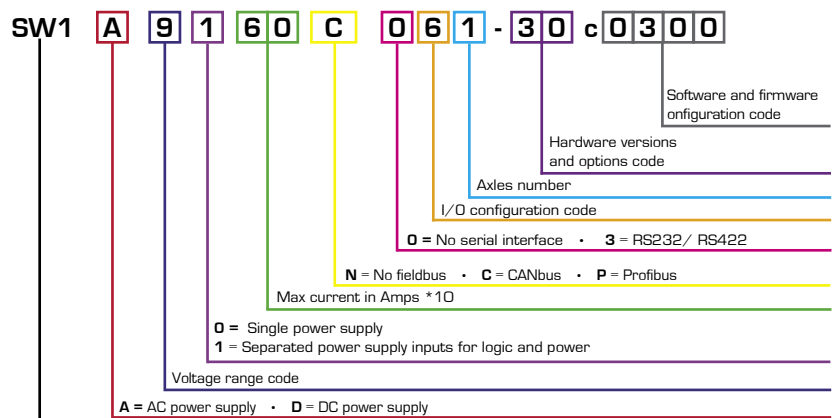

SW1 = Wall mounting software controlled drives

Specifications:

Power stages: 40 kHz H-bridge Bipolar chopper.

Optically isolated inputs: up to 8 digital optoisolated inputs 5 Vdc line driver or 24 Vdc NPN or PNP(200 kHz).

Optically isolated output: 8 digital optoisolated output 24 Vdc – 100 mA (700 mA for 170 models).

Analog Input: 2± 10 Vdc or for potentiometer.

Step resolution: from 1 to 128 micro steps.

Safety protections: over/under-voltage, over current, over temperature, open windings, closed windings phase/phase phase/ground.

Drive Status Monitoring: seven segments display or 2 status LEDs.

Temperature: working temp. 0°C+50°C, storage temp. 0°C+55°C.

Humidity: 0%+90%.

Protection class: IP20.

Control modalities:

- Velocity Control Mode
- Wide range of Positioning Control Modes (homing, relative, absolute, target)
- Electric Gear with programmable gear ratio to track external master reference (from fieldbus or incremental encoder) of motor Speed and Position
- High speed I/O triggered motor start & stop to event synchronizing for fast response demanding application: labelling, nick_finder, on fly cut., etc ...
- Multi Axis movements synchronization capability
- On fly change among any Motion Module Control Modes
- On fly Electric Gear Enable/Disable capability
- Motor Stall detection & Target Position tracking through encoder feedback
- The control by commands deriving from a master controller is suitable for multi-axes systems existing of up to 127 drives. The integrated power Motion module ensure a perfect synchronization between the axes and reduce the workload of the master controller.

Homing Motion Profile

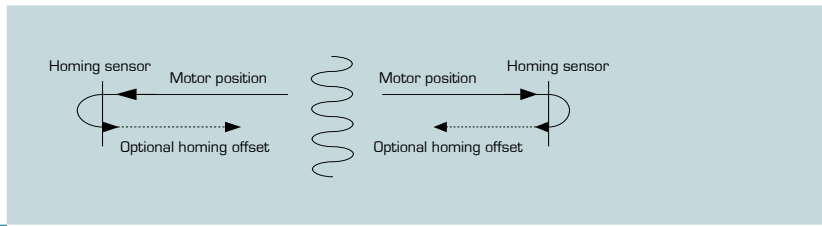

Mixed Motion Profile

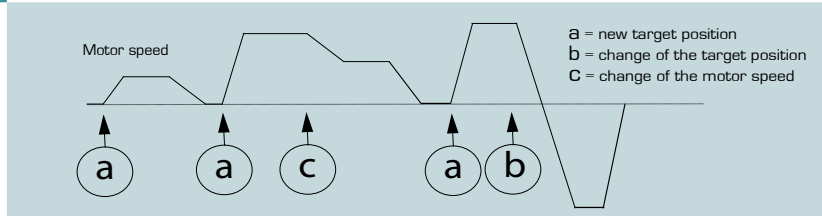

Multi-axes synchronization

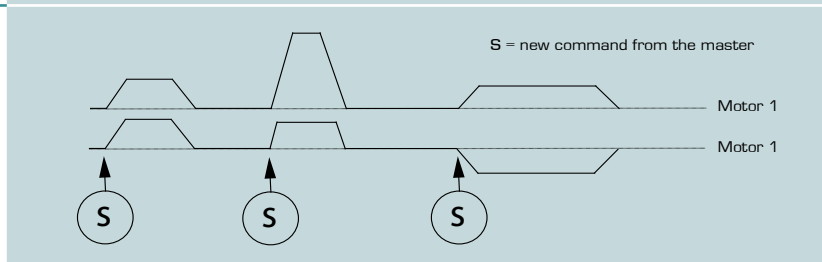

CANopen Slave Mode - c0300

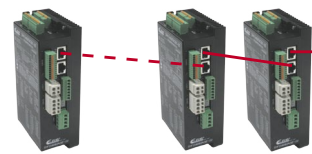

Modbus Slave Mode - c0400

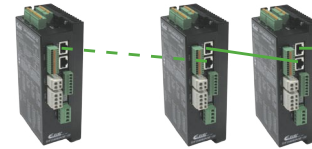

Profibus-DP Slave Mode - c0700

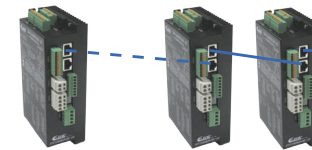

Profibus or DeviceNet Slave Mode

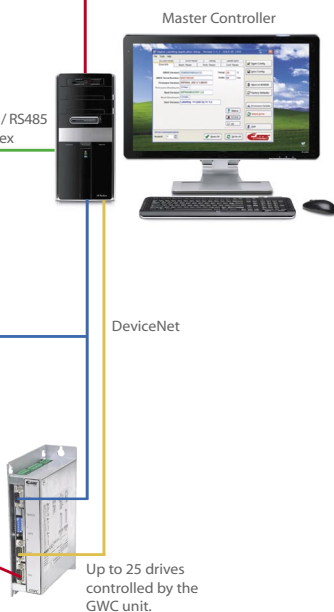
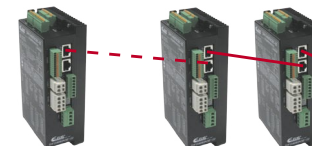

The software tool for windows Pc SL_Monitor allows the settings of the drive's parameters and a quick and easy application debug.

Order code		Power			Digital inputs
Versions	Configurations	Power supply		Current	
		Logic	Power		
2142 Models					
SW1D2142C061-00	c0300	24 ÷ 40 Vdc	24 ÷ 40 Vdc	0 ÷ 4.2 Arms (0 ÷ 6.0 Apeak)	4 optoisolated 200 kHz 5Vdc line driver or 24 Vdc PNP
SW1D2142C061-00	c0380	24 ÷ 40 Vdc	24 ÷ 40 Vdc	0 ÷ 4.2 Arms (0 ÷ 6.0 Apeak)	4 optoisolated 200 kHz 5Vdc line driver or 24 Vdc PNP
SW1D2142N361-00	c0400	24 ÷ 40 Vdc	24 ÷ 40 Vdc	0 ÷ 4.2 Arms (0 ÷ 6.0 Apeak)	4 optoisolated 200 kHz 5Vdc line driver or 24 Vdc PNP
3142 Models					
SW1D3142C061-10	c0300	24 ÷ 40 Vdc	24 ÷ 80 Vdc	0 ÷ 4.2 Arms (0 ÷ 6.0 Apeak)	4 optoisolated 200 kHz 5Vdc line driver or 24 Vdc PNP
SW1D3142C061-10	c0380	24 ÷ 40 Vdc	24 ÷ 80 Vdc	0 ÷ 4.2 Arms (0 ÷ 6.0 Apeak)	4 optoisolated 200 kHz 5Vdc line driver or 24 Vdc PNP
SW1D3142N361-10	c0400	24 ÷ 40 Vdc	24 ÷ 80 Vdc	0 ÷ 4.2 Arms (0 ÷ 6.0 Apeak)	4 optoisolated 200 kHz 5Vdc line driver or 24 Vdc PNP
4080 Models					
SW1D4080N3B1-00	c0400	24 ÷ 140 Vdc	48 ÷ 140 Vdc	0 ÷ 8.0 Arms (0 ÷ 11.0 Apeak)	16 optoisolated
SW1A4080C0B1-00	c0300	17 ÷ 100 Vac	34 ÷ 100 Vac	0 ÷ 8.0 Arms (0 ÷ 11.0 Apeak)	16 optoisolated
SW1A4080C0B1-00	c0380	17 ÷ 100 Vac	34 ÷ 100 Vac	0 ÷ 8.0 Arms (0 ÷ 11.0 Apeak)	16 optoisolated
SW1A4080N3B1-00	c0400	17 ÷ 100 Vac	34 ÷ 100 Vac	0 ÷ 8.0 Arms (0 ÷ 11.0 Apeak)	16 optoisolated
4085 Models					
SW1D4085C061-00	c0300	24 ÷ 140 Vdc	24 ÷ 140 Vdc	0 ÷ 8.5 Arms (0 ÷ 12.0 Apeak)	4 optoisolated 200 kHz 2 ÷ 5Vdc line driver or 11 ÷ 24 Vdc PNP
SW1D4085C061-00	c0380	24 ÷ 140 Vdc	24 ÷ 140 Vdc	0 ÷ 8.5 Arms (0 ÷ 12.0 Apeak)	4 optoisolated 200 kHz 2 ÷ 5Vdc line driver or 11 ÷ 24 Vdc PNP
SW1D4085N361-00	c0400	24 ÷ 140 Vdc	24 ÷ 140 Vdc	0 ÷ 8.5 Arms (0 ÷ 12.0 Apeak)	4 optoisolated 200 kHz 2 ÷ 5Vdc line driver or 11 ÷ 24 Vdc PNP
SW1A4085C061-00	c0300	17 ÷ 100 Vac	17 ÷ 100 Vac	0 ÷ 8.5 Arms (0 ÷ 12.0 Apeak)	4 optoisolated 200 kHz 2 ÷ 5Vdc line driver or 11 ÷ 24 Vdc PNP
SW1A4085C061-00	c0380	17 ÷ 100 Vac	17 ÷ 100 Vac	0 ÷ 8.5 Arms (0 ÷ 12.0 Apeak)	4 optoisolated 200 kHz 2 ÷ 5Vdc line driver or 11 ÷ 24 Vdc PNP
SW1A4085N361-00	c0400	17 ÷ 100 Vac	17 ÷ 100 Vac	0 ÷ 8.5 Arms (0 ÷ 12.0 Apeak)	4 optoisolated 200 kHz 2 ÷ 5Vdc line driver or 11 ÷ 24 Vdc PNP
4185 Models					
SW1A4185F161-00	c0500	24 Vdc	17 ÷ 100 Vac	0 ÷ 8.5 Arms (0 ÷ 12.0 Apeak)	4 optoisolated 200 kHz 2 ÷ 5Vdc line driver or 11 ÷ 24 Vdc PNP
SW1A4185H161-00	c0680	24 Vdc	17 ÷ 100 Vac	0 ÷ 8.5 Arms (0 ÷ 12.0 Apeak)	4 optoisolated 200 kHz 2 ÷ 5Vdc line driver or 11 ÷ 24 Vdc PNP
9060 Models					
SW1A9060C061-00	c0300	115 ÷ 230 Vac		0 ÷ 6.0 Arms (0 ÷ 8.46 Apeak)	4 optoisolated 200 kHz 5Vdc line driver or 24 Vdc PNP
SW1A9060C061-00	c0380	115 ÷ 230 Vac		0 ÷ 6.0 Arms (0 ÷ 8.46 Apeak)	4 optoisolated 200 kHz 5Vdc line driver or 24 Vdc PNP
SW1A9060N361-00	c0400	115 ÷ 230 Vac		0 ÷ 6.0 Arms (0 ÷ 8.46 Apeak)	4 optoisolated 200 kHz 5Vdc line driver or 24 Vdc PNP
SW1A9060N3C1-00	c0400	115 ÷ 230 Vac		0 ÷ 6.0 Arms (0 ÷ 8.46 Apeak)	16 optoisolated
9160 Models					
SW1A9160C061-00	c0300	115 ÷ 230 Vac	115 ÷ 230 Vac	0 ÷ 6.0 Arms (0 ÷ 8.46 Apeak)	4 optoisolated 200 kHz 5Vdc line driver or 24 Vdc PNP
SW1A9160C0C1-00	c0300	115 ÷ 230 Vac	115 ÷ 230 Vac	0 ÷ 6.0 Arms (0 ÷ 8.46 Apeak)	16 optoisolated
SW1A9160C061-00	c0380	115 ÷ 230 Vac	115 ÷ 230 Vac	0 ÷ 6.0 Arms (0 ÷ 8.46 Apeak)	4 optoisolated 200 kHz 5Vdc line driver or 24 Vdc PNP
SW1A9160C0C1-00	c0380	115 ÷ 230 Vac	115 ÷ 230 Vac	0 ÷ 6.0 Arms (0 ÷ 8.46 Apeak)	16 optoisolated
SW1A9160N361-00	c0400	115 ÷ 230 Vac	115 ÷ 230 Vac	0 ÷ 6.0 Arms (0 ÷ 8.46 Apeak)	4 optoisolated 200 kHz 5Vdc line driver or 24 Vdc PNP
SW1A9160N3C1-00	c0400	115 ÷ 230 Vac	115 ÷ 230 Vac	0 ÷ 6.0 Arms (0 ÷ 8.46 Apeak)	16 optoisolated

System resources					Mechanical data	
Digital outputs	Analog inputs	Analog outputs	Interface	Protocol	Dimensions	Weight
2 optoisolated 24 Vdc 100 mA	2 ±10Vcc o potenziometro	---	CANbus	CANopen	142.0x74.0x37.0 mm	500 g.
2 optoisolated 24 Vdc 100 mA	2 ±10Vcc o potenziometro	---	CANbus	CANopen DSP402	142.0x74.0x37.0 mm	500 g.
2 optoisolated 24 Vdc 100 mA	2 ±10Vdc or potentiometer	---	Serial RS232/422/485	Modbus-RTU	142.0x74.0x37.0 mm	500 g.
2 optoisolated 24 Vdc 100 mA	2 ±10Vcc o potenziometro	---	CANbus	CANopen	142.0x74.0x37.0 mm	500 g.
2 optoisolated 24 Vdc 100 mA	2 ±10Vcc o potenziometro	---	CANbus	CANopen DSP402	142.0x74.0x37.0 mm	500 g.
2 optoisolated 24 Vdc 100 mA	2 ±10Vdc or potentiometer	---	Serial RS232/422/485	Modbus-RTU	142.0x74.0x37.0 mm	500 g.
10 optoisolated 24Vdc 100 mA (2) and 300 mA (8)	2 ±10Vdc or potentiometer	---	Serial RS232/422/485	Modbus-RTU	165.0x97.5x54.3 mm	720 g.
10 optoisolated 24Vdc 100 mA (2) and 300 mA (8)	2 ±10Vdc or potentiometer	---	CANbus	CANopen	165.0x97.5x54.3 mm	900 g.
10 optoisolated 24Vdc 100 mA (2) and 300 mA (8)	2 ±10Vdc or potentiometer	---	CANbus	CANopen DSP402	165.0x97.5x54.3 mm	900 g.
10 optoisolated 24Vdc 100 mA (2) and 300 mA (8)	2 ±10Vdc or potentiometer	---	Serial RS232/422/485	Modbus-RTU	165.0x97.5x62.3 mm	900 g.
2 optoisolated 24 Vdc 100 mA	2 ±10Vdc or potentiometer	---	CANbus	CANopen	165.0x108.0x49.0 mm	800 g.
2 optoisolated 24 Vdc 100 mA	2 ±10Vdc or potentiometer	---	CANbus	CANopen DSP402	165.0x108.0x49.0 mm	800 g.
2 optoisolated 24 Vdc 100 mA	2 ±10Vdc or potentiometer	---	Serial RS232/422/485	Modbus-RTU	165.0x108.0x49.0 mm	800 g.
2 optoisolated 24 Vdc 100 mA	2 ±10Vdc or potentiometer	---	CANbus	CANopen	165.0x108.0x49.0 mm	800 g.
2 optoisolated 24 Vdc 100 mA	2 ±10Vdc or potentiometer	---	CANbus	CANopen DSP402	165.0x108.0x49.0 mm	800 g.
2 optoisolated 24 Vdc 100 mA	2 ±10Vdc or potentiometer	---	Serial RS232/422/485	Modbus-RTU	165.0x108.0x49.0 mm	800 g.
2 optoisolated 24 Vdc 100 mA	2 ±10Vdc or potentiometer	---	Profibus Serial RS232 CANbus	Profibus-DP	165.0x108.0x54.0 mm	865 g.
2 optoisolated 24 Vdc 100 mA	2 ±10Vdc or potentiometer	---	Ethernet Serial RS232 CANbus	EtherCAT	165.0x108.0x54.0 mm	865 g.
2 optoisolated 24 Vdc 100 mA	2 ±10Vdc or potentiometer	---	CANbus	CANopen	235.0x151.5x62.5 mm	1400 g.
2 optoisolated 24 Vdc 100 mA	2 ±10Vdc or potentiometer	---	CANbus	CANopen DSP402	235.0x151.5x62.5 mm	1400 g.
2 optoisolated 24 Vdc 100 mA	2 ±10Vdc or potentiometer	---	Serial RS232/422/485	Modbus-RTU	235.0x151.5x62.5 mm	1400 g.
10 optoisolated 24Vdc 100 mA (2) and 300 mA (8)	2 ±10Vdc or potentiometer	---	Serial RS232/422/485	Modbus-RTU	235.0x151.5x62.5 mm	1400 g.
2 optoisolated 24 Vdc 100 mA	2 ±10Vdc or potentiometer	---	CANbus	CANopen	235.0x151.5x62.5 mm	1400 g.
10 optoisolated 24Vdc 100 mA (2) and 300 mA (8)	2 ±10Vdc or potentiometer	2 ±10Vdc	CANbus	CANopen	235.0x151.5x62.5 mm	1400 g.
2 optoisolated 24 Vdc 100 mA	2 ±10Vdc or potentiometer	---	CANbus	CANopen DSP402	235.0x151.5x62.5 mm	1400 g.
10 optoisolated 24Vdc 100 mA (2) and 300 mA (8)	2 ±10Vdc or potentiometer	2 ±10Vdc	CANbus	CANopen DSP402	235.0x151.5x62.5 mm	1400 g.
2 optoisolated 24 Vdc 100 mA	2 ±10Vdc or potentiometer	---	Serial RS232/422/485	Modbus-RTU	235.0x151.5x62.5 mm	1400 g.
10 optoisolated 24Vdc 100 mA (2) and 300 mA (8)	2 ±10Vdc or potentiometer	2 ±10Vdc	Serial RS232/422/485	Modbus-RTU	235.0x151.5x62.5 mm	1400 g.

Enhanced drives



Description:

The SD fieldbus drives are Full Digital high performance micro-step devices, able to control stepper motors through Canopen, Profibus-DP or Modbus-RTU commands, also in **closed loop of torque, speed and position in slave mode**.

With their embedded Advanced Power Motion Module and the inputs and outputs they are suitable for local devices to be easily connected to fieldbus systems for the driving of 2 or 4 phase hybrid stepper motors.

A wide drives series of different power levels are available to combine with motor series with a flange size from 1.7" to 4.2". These drives can be applied to many machine types such as labelling systems, laser cutters, pick-and-place devices, incision tables, etc. and are suitable for applications requiring a high precision, speed and easiness of use. The units can be configured with ad hoc firmware to immediately realize complete applications, such as labelling systems with advanced functions, thread guiding and advanced indexing on specific placements.

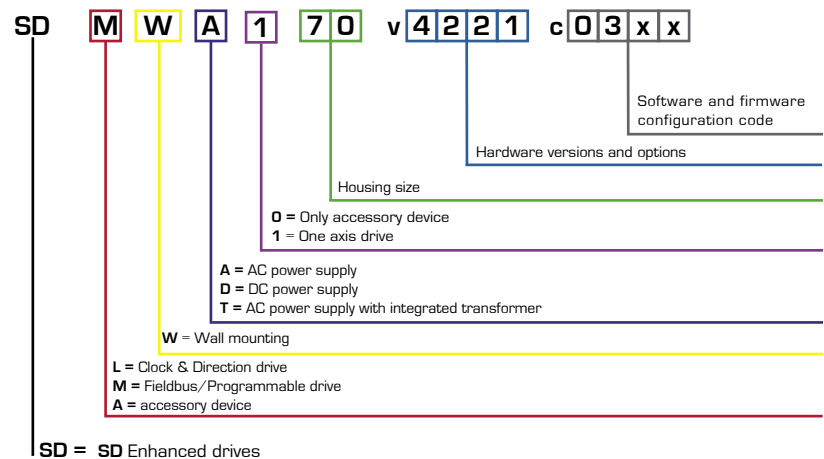

Specifications:

Power stages: 40 kHz H-bridge Bipolar chopper.

Optoisolated control busses: CANbus, Profibus or Serial.

Optically isolated inputs: up to 8 digital.

Optically isolated output: up to 8 digital.

Step resolution: from 1 to 128 micro steps(open loop) / StepLess technology (closed loop).

Safety protections: over/under-voltage, over current, over temperature, open windings, closed windings phase/phase phase/ground.

Drive Status Monitoring: seven segments led display

Temperature: working temp. 0°C+50°C, storage temp. 0°C+55°C

Humidity: 0%+90%.

Protection class: IP20.

Control modalities:

- Velocity Control Mode
- Wide range of Positioning Control Modes (homing, relative, absolute, target)
- Electric Gear with programmable gear ratio to track external master reference (from fieldbus or incremental encoder) of motor Speed and Position
- High speed I/O triggered motor start & stop to event synchronizing for fast response demanding application: labelling, nick_finder, on fly cut., etc ...
- Multi Axis movements synchronization capability
- On fly change among any Motion Module Control Modes
- On fly Electric Gear Enable/Disable capability
- Motor Stall detection & Target Position tracking through encoder feedback

Homing Motion Profile

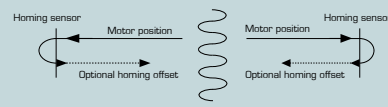

Mixed Motion Profile

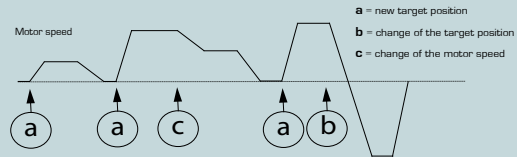

Multi-axes synchronization

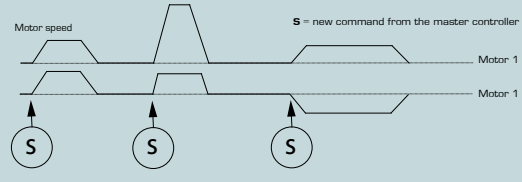

• Advantages of Closed Loop Control:

- with regard to an Open Loop Stepper Solution:
 - reliable positioning without synchronism loss;
 - keeps the original position stable and recovers it automatically in case of positioning errors caused by external factors such as mechanical vibrations;
 - 100% use of the motor torque;
 - capacity to operate at high velocity related to the current control, which is adjusted depending on the load variations, where the normal systems in open loop use a constant current control at all velocities without considering the load variations.
- compared with a brushless servo controlled solution:
 - no need to adjust the power (automatic current regulation depending on the load changes);
 - keeping the position stable without fluctuations after completing the positioning;
 - quick positioning favoured by the independent control of the integrated DSP;
 - continuous and fast execution of short stroke movements thanks to the short positioning time.

Open Loop Control



Closed Loop Control

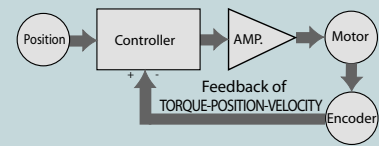

Drive control through commands by Master Controller. Suitable for multi axes systems (up to 127 drives). Built in Powerful Motion Module functionality assures perfect synchronization among axes and reduces Master Controller workload.

The software tool for windows Pc SDM_Monitor allows the settings of the drive's parameters and a quick and easy application debug.

- Moreover, with the following firmware configurations with these units it's possible to execute the following special applications:
 - c0302:** - 'CANBus Indexing' to move the motor on the precise positions with Canopen commands or by means of the I/O-s.
 - c0402:** - 'Modbus Indexing' to move the motor on the precise positions with Canopen commands or by means of the I/O-s.
 - c0327:** - 'Electronic CAM' to realize rotary labelling machines.

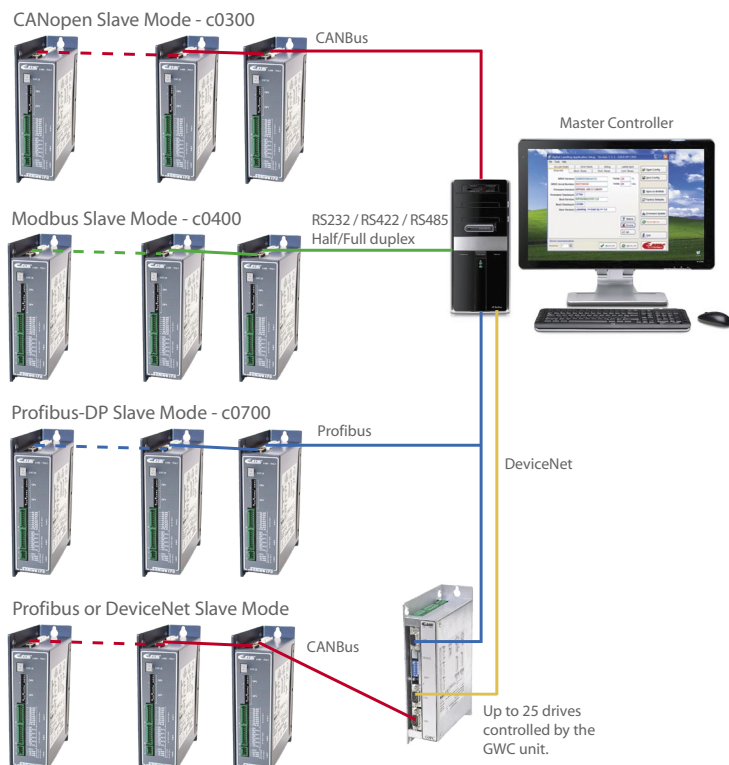

Order code		Power		Current	Digital inputs
Versions	Configurations	Power supply			
		Logic	Power		
170 Models					
SDMWD170vB221	c0300	24 ÷ 140 Vdc	24 ÷ 140 Vdc	1.0 ÷ 8.0 Arms (1.4 ÷ 11.2 Apeak)	4 optoisolated 200kHz 5 Vdc line driver or 24 Vdc PNP
SDMWD170vB231	c0400	24 ÷ 140 Vdc	24 ÷ 140 Vdc	1.0 ÷ 8.0 Arms (1.4 ÷ 11.2 Apeak)	4 optoisolated 200kHz 5 Vdc line driver or 24 Vdc PNP
SDMWD170vB242	c0300	24 ÷ 140 Vdc	24 ÷ 140 Vdc	1.0 ÷ 8.0 Arms (1.4 ÷ 11.2 Apeak)	8 optoisolated 200kHz 5 Vdc line driver or 24 Vdc PNP
SDMWD170vB242	c0400	24 ÷ 140 Vdc	24 ÷ 140 Vdc	1.0 ÷ 8.0 Arms (1.4 ÷ 11.2 Apeak)	8 optoisolated 200kHz 5 Vdc line driver or 24 Vdc PNP
SDMWA170v2221	c0300	24 ÷ 90 Vac	24 ÷ 90 Vac	1.0 ÷ 8.0 Arms (1.4 ÷ 11.2 Apeak)	4 optoisolated 200kHz 5 Vdc line driver or 24 Vdc PNP
SDMWA170v2231	c0400	24 ÷ 90 Vac	24 ÷ 90 Vac	1.0 ÷ 8.0 Arms (1.4 ÷ 11.2 Apeak)	4 optoisolated 200kHz 5 Vdc line driver or 24 Vdc PNP
SDMWA170v2242	c0300	24 ÷ 90 Vac	24 ÷ 90 Vac	1.0 ÷ 8.0 Arms (1.4 ÷ 11.2 Apeak)	8 optoisolated 200kHz 5 Vdc line driver or 24 Vdc PNP
SDMWA170v2242	c0400	24 ÷ 90 Vac	24 ÷ 90 Vac	1.0 ÷ 8.0 Arms (1.4 ÷ 11.2 Apeak)	8 optoisolated 200kHz 5 Vdc line driver or 24 Vdc PNP
SDMWA170v4221	c0300	18 Vac (24 Vdc user output)	24 ÷ 90 Vac	1.0 ÷ 8.0 Arms (1.4 ÷ 11.2 Apeak)	4 optoisolated 200kHz 5 Vdc line driver or 24 Vdc PNP
SDMWA170v4231	c0400	18 Vac (24 Vdc user output)	24 ÷ 90 Vac	1.0 ÷ 8.0 Arms (1.4 ÷ 11.2 Apeak)	4 optoisolated 200kHz 5 Vdc line driver or 24 Vdc PNP
SDMWA170v4242	c0300	18 Vac (24 Vdc user output)	24 ÷ 90 Vac	1.0 ÷ 8.0 Arms (1.4 ÷ 11.2 Apeak)	8 optoisolated 200kHz 5 Vdc line driver or 24 Vdc PNP
SDMWA170v4242	c0400	18 Vac (24 Vdc user output)	24 ÷ 90 Vac	1.0 ÷ 8.0 Arms (1.4 ÷ 11.2 Apeak)	8 optoisolated 200kHz 5 Vdc line driver or 24 Vdc PNP
180 Models					
SDMWD180vA123	c0300	24 ÷ 70 Vdc		0.5 ÷ 5.0 Arms (0.7 ÷ 7.0 Apeak)	4 optoisolated 200kHz 5 Vdc line driver or 24 Vdc PNP
SDMWD180vA133	c0400	24 ÷ 70 Vdc		0.5 ÷ 5.0 Arms (0.7 ÷ 7.0 Apeak)	4 optoisolated 200kHz 5 Vdc line driver or 24 Vdc PNP
SDMWA180vA123	c0300	24 ÷ 48 Vac		0.5 ÷ 5.0 Arms (0.7 ÷ 7.0 Apeak)	4 optoisolated 200kHz 5 Vdc line driver or 24 Vdc PNP
SDMWA180vA133	c0400	24 ÷ 48 Vac		0.5 ÷ 5.0 Arms (0.7 ÷ 7.0 Apeak)	4 optoisolated 200kHz 5 Vdc line driver or 24 Vdc PNP
SDMWT180vA123	c0300	115 ÷ 230 Vac		0.5 ÷ 5.0 Arms (0.7 ÷ 7.0 Apeak)	4 optoisolated 200kHz 5 Vdc line driver or 24 Vdc PNP
SDMWT180vA133	c0400	115 ÷ 230 Vac		0.5 ÷ 5.0 Arms (0.7 ÷ 7.0 Apeak)	4 optoisolated 200kHz 5 Vdc line driver or 24 Vdc PNP

System resources				Mechanical data	
Digital outputs	Analog inputs	Interface	Protocol	Dimensions	Weight
4 optoisolated 24 Vdc 500 mA	1 ±10 Vdc or potentiometer	CANbus	CANopen	175.0x47.7x123.3 mm	770 g.
4 optoisolated 24 Vdc 500 mA	1 ±10 Vdc or potentiometer	Serial RS232/422/485	Modbus-RTU	175.0x47.7x123.3 mm	770 g.
8 optoisolated 24 Vdc 500 mA	1 ±10 Vdc or potentiometer	Serial RS232/422/485	CANopen	175.0x47.7x123.3 mm	770 g.
8 optoisolated 24 Vdc 500 mA	1 ±10 Vdc or potentiometer	Serial RS232/422/485 CANbus	Modbus-RTU	175.0x47.7x123.3 mm	770 g.
4 optoisolated 24 Vdc 500 mA	1 ±10 Vdc or potentiometer	CANbus	CANopen	175.0x88.3x123.3 mm	800 g.
4 optoisolated 24 Vdc 500 mA	1 ±10 Vdc or potentiometer	Serial RS232/422/485	Modbus-RTU	175.0x88.3x123.3 mm	800 g.
8 optoisolated 24 Vdc 500 mA	1 ±10 Vdc or potentiometer	CANbus Serial RS232/422/485	CANopen	175.0x88.3x123.3 mm	800 g.
8 optoisolated 24 Vdc 500 mA	1 ±10 Vdc or potentiometer	Serial RS232/422/485 CANbus	Modbus-RTU	175.0x88.3x123.3 mm	800 g.
4 optoisolated 24 Vdc 500 mA	1 ±10 Vdc or potentiometer	CANbus	CANopen	175.0x88.3x123.3 mm	800 g.
4 optoisolated 24 Vdc 500 mA	1 ±10 Vdc or potentiometer	Serial RS232/422/485	Modbus-RTU	175.0x88.3x123.3 mm	800 g.
8 optoisolated 24 Vdc 500 mA	1 ±10 Vdc or potentiometer	CANbus Serial RS232/422/485	CANopen	175.0x88.3x123.3 mm	800 g.
8 optoisolated 24 Vdc 500 mA	1 ±10 Vdc or potentiometer	Serial RS232/422/485 CANbus	Modbus-RTU	175.0x88.3x123.3 mm	800 g.
3 optoisolated 24 Vdc 100 mA	2 ±10 Vdc or potentiometer	CANbus	CANopen	175.0x47.7x123.3 mm	680 g.
3 optoisolated 24 Vdc 100 mA	2 ±10 Vdc or potentiometer	Serial RS232/422/485	Modbus-RTU	175.0x47.7x123.3 mm	680 g.
3 optoisolated 24 Vdc 100 mA	2 ±10 Vdc or potentiometer	CANbus	CANopen	175.0x47.7x123.3 mm	810 g.
3 optoisolated 24 Vdc 100 mA	2 ±10 Vdc or potentiometer	Serial RS232/422/485	Modbus-RTU	175.0x47.7x123.3 mm	810 g.
3 optoisolated 24 Vdc 100 mA	2 ±10 Vdc or potentiometer	CANbus	CANopen	175.0x118.6x124.3 mm	1500 g.
3 optoisolated 24 Vdc 100 mA	2 ±10 Vdc or potentiometer	Serial RS232/422/485	Modbus-RTU	175.0x118.6x124.3 mm	1500 g.



SM1A Drive, 60 mm Motor and Encoder in one device

Main features:

- Multiform Control Modes
- On Board Safety provisions
 - ✓ fully tested for direct installation unit
 - ✓ built in watch dog functionality
 - ✓ fault monitoring and handling
 - ✓ on field working errors buffering
 - ✓ separated power supply for logic and power
- Main advantages of the drives:
 - ✓ low motor vibration
 - ✓ low mechanical noise
 - ✓ low heat production
 - ✓ AC power supply
 - ✓ protection class IP65
 - ✓ no resonance
 - ✓ high reliability
 - ✓ wide range of power

Description:

The fieldbus drives with integrated motor of the **SM1A** series with c0300 (Canopen) or c0400 (Modbus) firmware, are high-performance devices, consisting of a *Full Digital* drive based on the precise pwm technology embedded in the f⁴d² firmware to control the sinusoidal current, a 50 poles high torque motor and an optional encoder for motor stall detection & target position tracking with less noise, less heating, smooth motions and energy saving. The SM1A driver are easy to install in CANBus or Serial networks as slave unit and easy to configure thanks to PC Windows interface SL-Monitor, and are available in a wide power range with 2.4" flange (60 mm) motors. Besides compactness and power, the SM1A series offers maximum versatility and reliability, and a remarkable saving of wiring and electrical switchboards. With the hardware resources available in the different drive versions, along with the *Advanced Power Motion Module* you can create and test your applications fast and easy. These drives configured with ad hoc firmwares are able to realize complete applications like: labelling machines with advanced functions and indexing to specific positions.

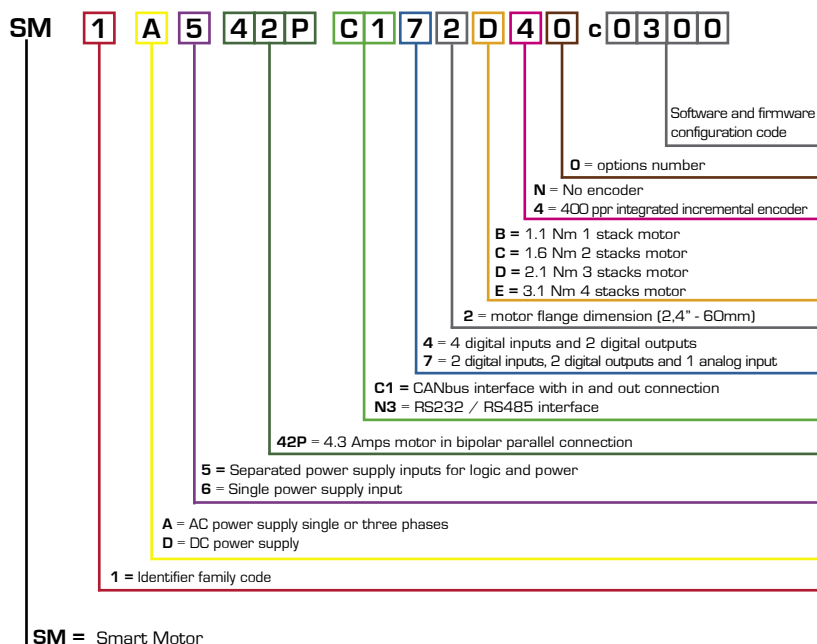

Specifications:

Torque: 1.1 Nm, 1.65 Nm, 2.1 Nm, 3.1 Nm motors.
Power stage: 40 kHz H-bridge Bipolar chopper.
Optoisolated control busses: RS232 / RS485 / CANbus.
Optoisolated inputs: 4 digital.
Optoisolated outputs: 2 digital.
Analog input: 1 ±10Vdc or potentiometer.
Step resolution: from 1 to 128 microsteps.
Safety protection: Over/Under-voltage, Over Current, Over Temperature, Open Windings, Closed Windings Phase/Phase, Phase/Ground.
Temperature: working temp. 0°C+50°C, storage temp. 0°C+55°C.
Humidity: 0%+90%.
Protection class: IP65.

Control modalities:

- Velocity Control Mode
- Wide range of Positioning Control Modes (homing, relative, absolute, target)
- Electric Gear with programmable gear ratio to track external master reference (from fieldbus or incremental encoder) of motor Speed and Position
- High speed I/O triggered motor start & stop to event synchronizing for fast response demanding application: labelling, nick_finder, on fly cut., etc ...
- Multi Axis movements synchronization capability
- On fly change among any Motion Module Control Modes
- On fly Electric Gear Enable/Disable capability
- Motor Stall detection & Target Position tracking through encoder feedback
- The control by commands deriving from a master controller is suitable for multi-axes systems existing of up to 127 drives. The integrated power Motion module ensure a perfect synchronization between the axes and reduce the workload of the master controller.

Homing Motion Profile

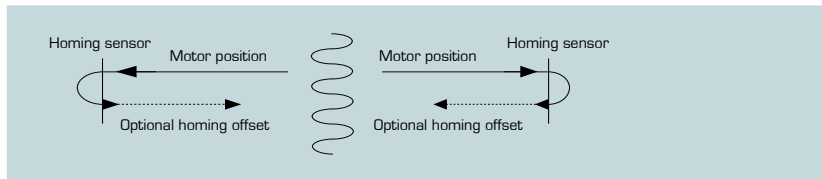

Mixed Motion Profile

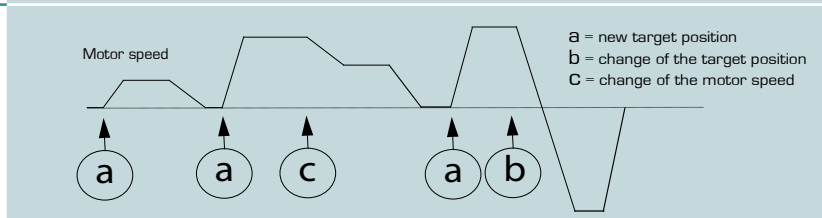

Multi-axes synchronization

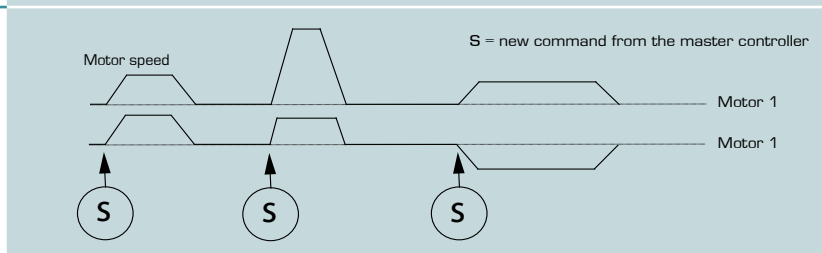

CANopen Slave - c0300

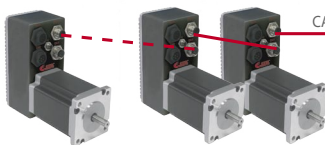

Modbus Slave - c0400

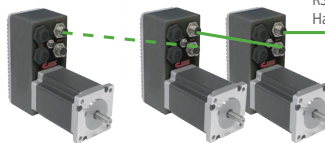

Profibus or DeviceNet Slave

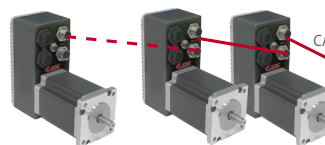

Suitable for multi axes systems (up to 127 drives).
Built in powerfull motion module functionality assure perfect sincronyzation among axes and reduces Master Controller workload.

Order code		Power			Motor	Digital inputs
Versions	Configurations	Power supply		Current		
		Logic	Power			
SM1A542PC142_40	c0300	24 Vdc	18 ÷ 48 Vac	4.2 Arms (6.0 Apeak)	B Holding torque 1.10 Nm±10% Phase resistance 0.44 ohm ±10% Phase inductance 2.54 mH ±10% Detent torque 0.05 Nm Rotor inertia 275 g.cm ²	4 optoisolated 200kHz 24Vdc
SM1A542PC142_N0	c0300	24 Vdc	18 ÷ 48 Vac	4.2 Arms (6.0 Apeak)		4 optoisolated 200kHz 24Vdc
SM1A542PC172_40	c0300	24 Vdc	18 ÷ 48 Vac	4.2 Arms (6.0 Apeak)		4 optoisolated 200kHz 24Vdc
SM1A542PC172_N0	c0300	24 Vdc	18 ÷ 48 Vac	4.2 Arms (6.0 Apeak)		4 optoisolated 200kHz 24Vdc
SM1A642PC142_40	c0300	18 ÷ 48 Vac		4.2 Arms (6.0 Apeak)	C Holding torque 1.65 Nm±10% Phase resistance 0.19 ohm ±10% Phase inductance 1.70 mH ±10% Detent torque 0.07 Nm Rotor inertia 300 g.cm ²	4 optoisolated 200kHz 24Vdc
SM1A642PC142_N0	c0300	18 ÷ 48 Vac		4.2 Arms (6.0 Apeak)		4 optoisolated 200kHz 24Vdc
SM1A642PC172_40	c0300	18 ÷ 48 Vac		4.2 Arms (6.0 Apeak)		4 optoisolated 200kHz 24Vdc
SM1A642PC172_N0	c0300	18 ÷ 48 Vac		4.2 Arms (6.0 Apeak)		4 optoisolated 200kHz 24Vdc
SM1A542PN342_40	c0400	24 Vdc	18 ÷ 48 Vac	4.2 Arms (6.0 Apeak)	D Holding torque 2.10 Nm±10% Phase resistance 0.27 ohm ±10% Phase inductance 3.00 mH ±10% Detent torque 0.09 Nm Rotor inertia 570 g.cm ²	4 optoisolated 200kHz 24Vdc
SM1A542PN342_N0	c0400	24 Vdc	18 ÷ 48 Vac	4.2 Arms (6.0 Apeak)		4 optoisolated 200kHz 24Vdc
SM1A542PN372_40	c0400	24 Vdc	18 ÷ 48 Vac	4.2 Arms (6.0 Apeak)		4 optoisolated 200kHz 24Vdc
SM1A542PN372_N0	c0400	24 Vdc	18 ÷ 48 Vac	4.2 Arms (6.0 Apeak)		4 optoisolated 200kHz 24Vdc
SM1A642PN342_40	c0400	18 ÷ 48 Vac		4.2 Arms (6.0 Apeak)	E Holding torque 3.30 Nm±10% Phase resistance 0.65 ohm ±10% Phase inductance 3.20 mH ±10% Detent torque 0.10 Nm Rotor inertia 840 g.cm ²	4 optoisolated 200kHz 24Vdc
SM1A642PN342_N0	c0400	18 ÷ 48 Vac		4.2 Arms (6.0 Apeak)		4 optoisolated 200kHz 24Vdc
SM1A642PN372_40	c0400	18 ÷ 48 Vac		4.2 Arms (6.0 Apeak)		4 optoisolated 200kHz 24Vdc
SM1A642PN372_N0	c0400	18 ÷ 48 Vac		4.2 Arms (6.0 Apeak)		4 optoisolated 200kHz 24Vdc

System resources					Mechanical data		
Digital outputs	Analog inputs	Interface	Encoder	Protocol			
2 optoisolated 24Vdc 100mA	---	CANbus Serial RS232 (Modbus only for drive parameters settings)	400 ppr incremental	CANopen	B Dimensions: 124.0x60.0x100.5 mm Motor shaft diameter: Ø 8.0 mm Motor shaft D-cut: 0.5x20.0 mm Weight: 1450 g.		
2 optoisolated 24Vdc 100mA	---	CANbus Serial RS232 (Modbus only for drive parameters settings)	---	CANopen			
2 optoisolated 24Vdc 100mA	1 ±10Vdc or potentiometer	CANbus Serial RS232 (Modbus only for drive parameters settings)	400 ppr incremental	CANopen			
2 optoisolated 24Vdc 100mA	1 ±10Vdc or potentiometer	CANbus Serial RS232 (Modbus only for drive parameters settings)	---	CANopen			
2 optoisolated 24Vdc 100mA	---	CANbus Serial RS232 (Modbus only for drive parameters settings)	400 ppr incremental	CANopen			
2 optoisolated 24Vdc 100mA	---	CANbus Serial RS232 (Modbus only for drive parameters settings)	---	CANopen		C Dimensions: 124.0x60.0x109.5 mm Motor shaft diameter: Ø 8.0 mm Motor shaft D-cut: 0.5x20.0 mm Weight: 1620 g.	
2 optoisolated 24Vdc 100mA	1 ±10Vdc or potentiometer	CANbus Serial RS232 (Modbus only for drive parameters settings)	400 ppr incremental	CANopen			
2 optoisolated 24Vdc 100mA	1 ±10Vdc or potentiometer	CANbus Serial RS232 (Modbus only for drive parameters settings)	---	CANopen			
2 optoisolated 24Vdc 100mA	---	Serial RS232/485	400 ppr incremental	Modbus-RTU			
2 optoisolated 24Vdc 100mA	---	Serial RS232/485	---	Modbus-RTU			D Dimensions: 124.0x60.0x120.5 mm Motor shaft diameter: Ø 8.0 mm Motor shaft D-cut: 0.5x20.0 mm Weight: 2050 g.
2 optoisolated 24Vdc 100mA	1 ±10Vdc or potentiometer	Serial RS232/485	400 ppr incremental	Modbus-RTU			
2 optoisolated 24Vdc 100mA	1 ±10Vdc or potentiometer	Serial RS232/485	---	Modbus-RTU			
2 optoisolated 24Vdc 100mA	---	Serial RS232/485	400 ppr incremental	Modbus-RTU			
2 optoisolated 24Vdc 100mA	---	Serial RS232/485	---	Modbus-RTU	E Dimensions: 124.0x60.0x141.5mm Motor shaft diameter: Ø 8.0 mm Motor shaft D-cut: 0.5x20.0 mm Weight: 2250 g.		
2 optoisolated 24Vdc 100mA	1 ±10Vdc or potentiometer	Serial RS232/485	400 ppr incremental	Modbus-RTU			
2 optoisolated 24Vdc 100mA	1 ±10Vdc or potentiometer	Serial RS232/485	---	Modbus-RTU			
2 optoisolated 24Vdc 100mA	---	Serial RS232/485	---	Modbus-RTU			



SM2A Drive, 86 mm Motor and Encoder in one device

Main features:

- Multiform Control Modes
- On Board Safety provisions:
 - ✓ fully tested for direct installation unit
 - ✓ built in watch dog functionality
 - ✓ fault monitoring and handling
 - ✓ on field working errors buffering
 - ✓ separated power supply for logic and power
- Main advantages of the drives:
 - ✓ low motor vibration
 - ✓ low mechanical noise
 - ✓ low heat production
 - ✓ closed loop of torque, velocity and position
 - ✓ protection class IP65
 - ✓ no resonance
 - ✓ high reliability
 - ✓ AC power supply
 - ✓ wide range of power

Description:

The **fieldbus** drives with integrated motor of the **SM2A** series with c0300 (Canopen) or c0400 (Modbus) firmware, are high-performance devices, consisting of a *Full Digital* drive based on the precise pwm technology embedded in the f⁴d² firmware to control the sinusoidal current, a 50 poles high torque motor and an optional encoder to **control the torque, velocity and position of the motor in open as well as in closed loop** for less noise, less heating, smooth motions and energy saving. The SM2A drives are easy to install in CANBus or Serial networks as slave unit and easy to configure thanks to PC Windows interface SDM-Monitor, and are available in a wide power range with 3.4" flange (86 mm) motors. Besides compactness and power, the SM2A series offers maximum versatility and reliability, and a remarkable saving of wiring and electrical switchboards. With the hardware resources available in the different drive versions, along with the advanced control mode implementations in the *real time power module* you can create and test your applications fast and easy.

These drives configured with ad hoc firmwares are able to realize complete applications like: labelling machines with advanced functions and indexing to specific positions.

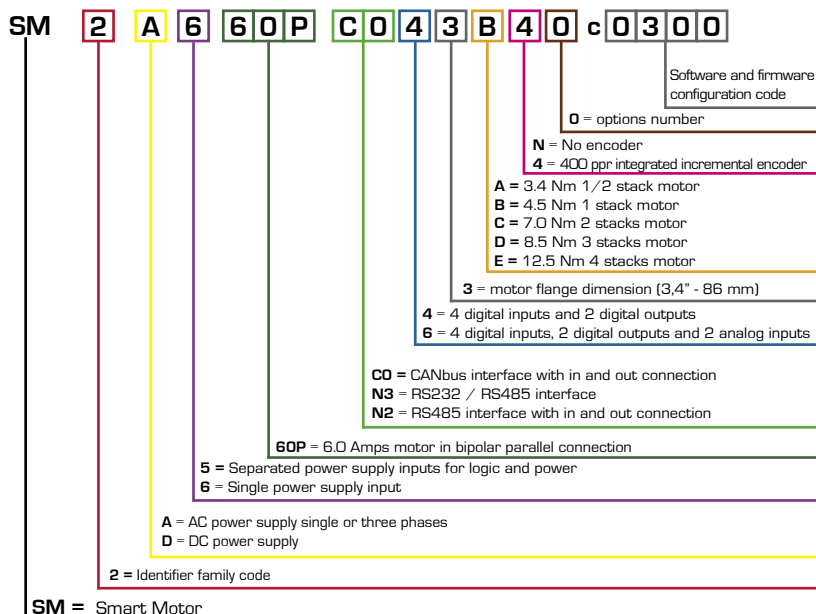

Specifications:

Torque: 3.4 Nm, 4.5 Nm, 7.0 Nm, 8.5 Nm, 12.5 Nm motors.

Power stage: 40 kHz H-bridge Bipolar chopper.

Current: 8.0 ARMS (11.0 Apeak).

Optoisolated control busses: RS232 / RS422 / RS485 / CANbus.

Inputs/Outputs: 4 digital optocoupled inputs / 2 digital optocoupled outputs (100 mA) 2 analog inputs (potentiometer or ±10Vdc).

Step resolution: from 1 to 128 microsteps (open loop) / StepLess technology (closed loop).

Safety protection: Over/Under-voltage, Over Current, Over Temperature, Open Windings, Closed Windings Phase/Phase, Phase/Ground.

Protection class: IP65.

Control modalities:

- Velocity Control Modality
- Wide range of positioning control modalities (homing, relative, absolute, target)
- Electric Gear with programmable gear ratio to track external master reference (from fieldbus or incremental encoder) of motor Speed and Position
- High speed I/O triggered motor start & stop to event synchronizing for fast response demanding application: labelling, nick_finder, on fly cut., etc ...
- Multi Axis movements synchronization capability
- On fly change among any Motion Module Control modalities
- On fly Electric Gear Enable/Disable capability
- Motor Stall detection & Target Position tracking through encoder feedback

Advantages of Closed Loop Control:

- with regard to an Open Loop Stepper Solution:
 - reliable positioning without synchronism loss;
 - keeps the original position stable and recovers it automatically in case of positioning errors caused by external factors such as mechanical vibrations;
 - 100% use of the motor torque;
 - capacity to operate at high velocity related to the current control, which is adjusted depending on the load variations, where the normal systems in open loop use a constant current control at all velocities without considering the load variations.
- compared with a brushless servo controlled solution:
 - no need to adjust the power (automatic current regulation depending on the load changes);
 - keeping the position stable without fluctuations after completing the positioning;
 - quick positioning favoured by the independent control of the integrated DSP;
 - continuous and fast execution of short stroke movements thanks to the short positioning time.

Profilo di Moto Homing

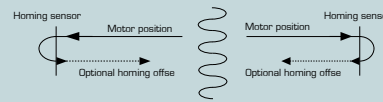

Profilo di Moto Misto

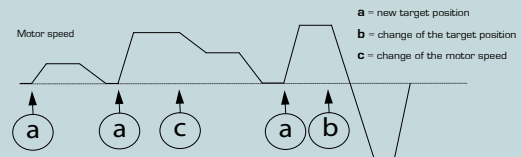

Sincronizzazione Multiasse

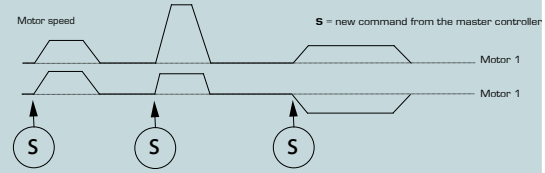

Open Loop Control



Closed Loop Control

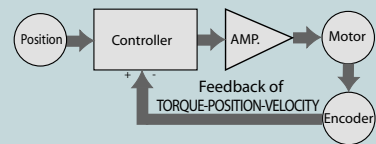

Drive control through commands by Master Controller. Suitable for multi axes systems (up to 127 drives). Built in power full motion module functionality assures perfect sincronyzation among axes and reduces Master Controller workload

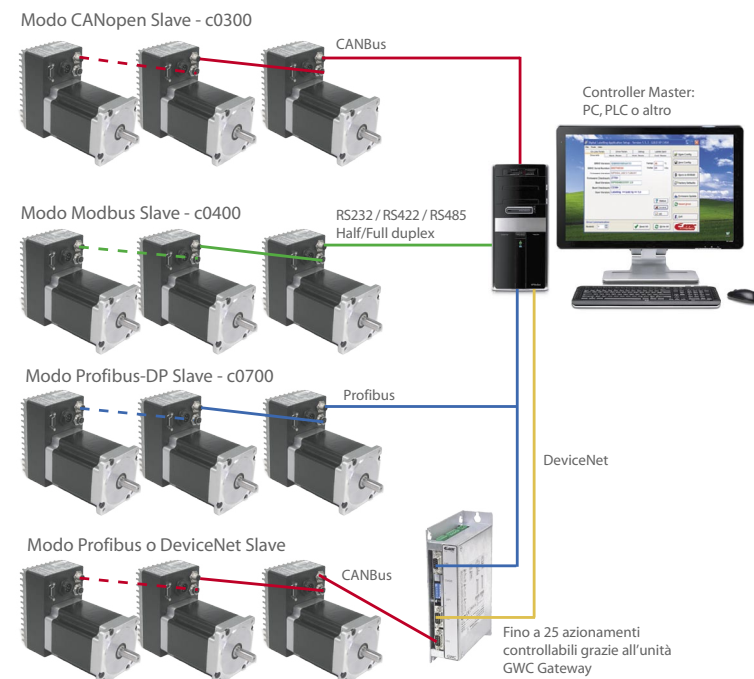

The software tool for windows Pc SDM_Monitor allows the settings of the drive's parameters and a quick and easy application debug.

- Moreover, with the following firmware configurations with these units it's possible to execute the following special applications:

- c0302** - 'CANBus Indexing' to move the motor on the precise positions with Can-open commands or by means of the I/O-s.
- c0402** - 'Modbus Indexing' to move the motor on the precise positions with Can-open commands or by means of the I/O-s.
- c0327** - 'Electronic CAM' to realize rotary labelling machines.

Order code		Power			Motor	Digital inputs	
Versions	Configurations	Power supply		Current			
		Logic	Power				
SM2A560PC043_40	c0300	24 Vdc	18 ÷ 100 Vac	0 ÷ 8.0 Arms (0 ÷ 11.0 Apeak)	A Holding torque 3.40 Nm±10% Phase resistance 0.29 ohm ±10% Phase inductance 1.70 mH ±10% Detent torque 0.08 Nm Rotor inertia 1000 g.cm ²	4 optoisolated 200 kHz 24 Vdc PNP or NPN*	
SM2A560PC043_50							
SM2A560PC063_40							
SM2A560PC063_50							
SM2A560PC043_N0	c0300	24 Vdc	18 ÷ 100 Vac	0 ÷ 8.0 Arms (0 ÷ 11.0 Apeak)		B Holding torque 4.50 Nm±10% Phase resistance 0.19 ohm ±10% Phase inductance 1.70 mH ±10% Detent torque 0.13 Nm Rotor inertia 1400 g.cm ²	4 optoisolated 200 kHz 24 Vdc PNP or NPN*
SM2A560PC063_N0							
SM2A660PC043_40	c0300		18 ÷ 100 Vac	0 ÷ 8.0 Arms (0 ÷ 11.0 Apeak)			4 optoisolated 200 kHz 24 Vdc PNP or NPN*
SM2A660PC043_50							
SM2A660PC063_40							
SM2A660PC063_50							
SM2A660PC043_N0	c0300		18 ÷ 100 Vac	0 ÷ 8.0 Arms (0 ÷ 11.0 Apeak)	C Holding torque 7.00 Nm±10% Phase resistance 0.25 ohm ±10% Phase inductance 2.50 mH ±10% Detent torque 0.21 Nm Rotor inertia 1900 g.cm ²		4 optoisolated 200 kHz 24 Vdc PNP or NPN*
SM2A660PC063_N0							
SM2A560PN243_40	c0400	24 Vdc	18 ÷ 100 Vac	0 ÷ 8.0 Arms (0 ÷ 11.0 Apeak)			4 optoisolated 200 kHz 24 Vdc PNP or NPN*
SM2A560PN243_50							
SM2A560PN263_40							
SM2A560PN263_50							
SM2A560PN243_N0	c0400	24 Vdc	18 ÷ 100 Vac	0 ÷ 8.0 Arms (0 ÷ 11.0 Apeak)		D Holding torque 8.50 Nm±10% Phase resistance 0.27 ohm ±10% Phase inductance 3.00 mH ±10% Detent torque 0.25 Nm Rotor inertia 2700 g.cm ²	4 optoisolated 200 kHz 24 Vdc PNP or NPN*
SM2A560PN263_N0							
SM2A660PN243_40	c0400		18 ÷ 100 Vac	0 ÷ 8.0 Arms (0 ÷ 11.0 Apeak)			4 optoisolated 200 kHz 24 Vdc PNP or NPN*
SM2A660PN243_50							
SM2A660PN263_40							
SM2A660PN263_50							
SM2A660PN243_N0	c0400		18 ÷ 100 Vac	0 ÷ 8.0 Arms (0 ÷ 11.0 Apeak)	E Holding torque 12.50 Nm±10% Phase resistance 0.35 ohm ±10% Phase inductance 4.80 mH ±10% Detent torque 0.38 Nm Rotor inertia 4000 g.cm ²		4 optoisolated 200 kHz 24 Vdc PNP or NPN*
SM2A660PN263_N0							
SM2A560PN343_40	c0400	24 Vdc	18 ÷ 100 Vac	0 ÷ 8.0 Arms (0 ÷ 11.0 Apeak)			4 optoisolated 200 kHz 24 Vdc PNP or NPN*
SM2A560PN343_50							
SM2A560PN363_40							
SM2A560PN363_50							
SM2A560PN343_N0	c0400	24 Vdc	18 ÷ 100 Vac	0 ÷ 8.0 Arms (0 ÷ 11.0 Apeak)		E Holding torque 12.50 Nm±10% Phase resistance 0.35 ohm ±10% Phase inductance 4.80 mH ±10% Detent torque 0.38 Nm Rotor inertia 4000 g.cm ²	4 optoisolated 200 kHz 24 Vdc PNP or NPN*
SM2A560PN363_N0							
SM2A660PN343_40	c0400		18 ÷ 100 Vac	0 ÷ 8.0 Arms (0 ÷ 11.0 Apeak)			4 optoisolated 200 kHz 24 Vdc PNP or NPN*
SM2A660PN343_50							
SM2A660PN363_40							
SM2A660PN363_50							
SM2A660PN343_N0	c0400		18 ÷ 100 Vac	0 ÷ 8.0 Arms (0 ÷ 11.0 Apeak)	E Holding torque 12.50 Nm±10% Phase resistance 0.35 ohm ±10% Phase inductance 4.80 mH ±10% Detent torque 0.38 Nm Rotor inertia 4000 g.cm ²		4 optoisolated 200 kHz 24 Vdc PNP or NPN*
SM2A660PN363_N0							

* = NPN for devices without analog input only.

System resources					Mechanical data
Digital outputs	Analog inputs	Interface	Encoder	Protocol	
2 optoisolated 24 Vdc 500 mA	---	CANbus	400 ppr incremental	CANopen	<p>A Dimensions: 135.0x86.0x150.5 mm Motor shaft diameter: Ø 9.525 mm Motor shaft key: 3.0x3.0x22.0 mm Weight: 2600 g.</p> <p>B Dimensions: 135.0x86.0x165.5 mm Motor shaft diameter: Ø 12.70 mm Motor shaft key 3.175x3.175x22.23 mm Weight: 3200 g.</p> <p>C Dimensions: 135.0x86.0x179.5 mm Motor shaft diameter: Ø 12.70 mm Motor shaft key 3.175x3.175x22.23 mm Weight: 4100 g.</p> <p>D Dimensions: 135.0x86.0x203.5 mm Motor shaft diameter: Ø 12.70 mm Motor shaft key 3.175x3.175x22.23 mm Weight: 4700 g.</p> <p>E Dimensions: 135.0x86.0x242.0 mm Motor shaft diameter: Ø 15.87 mm Motor shaft key 4.763x4.763x22.23 mm Weight: 6200 g.</p>
			1000 ppr incremental		
	400 ppr incremental				
	1000 ppr incremental				
2 optoisolated 24 Vdc 500 mA	2 ± 10 Vcc or potentiometer	CANbus	---	CANopen	
			---	CANopen	
2 optoisolated 24 Vdc 500 mA	---	CANbus	400 ppr incremental	CANopen	
			1000 ppr incremental		
	400 ppr incremental				
	1000 ppr incremental				
2 optoisolated 24 Vdc 500 mA	2 ± 10 Vcc or potentiometer	CANbus	---	CANopen	
			---	CANopen	
2 optoisolated 24 Vdc 500 mA	---	Serial RS485	400 ppr incremental	Modbus-RTU	
			1000 ppr incremental		
	400 ppr incremental				
	1000 ppr incremental				
2 optoisolated 24 Vdc 500 mA	2 ± 10 Vcc or potentiometer	Serial RS485	---	Modbus-RTU	
			---	Modbus-RTU	
2 optoisolated 24 Vdc 500 mA	---	Serial RS485	400 ppr incremental	Modbus-RTU	
			1000 ppr incremental		
	400 ppr incremental				
	1000 ppr incremental				
2 optoisolated 24 Vdc 500 mA	2 ± 10 Vcc or potentiometer	Serial RS485	---	Modbus-RTU	
			---	Modbus-RTU	
2 optoisolated 24 Vdc 500 mA	---	Serial RS232/485	400 ppr incremental	Modbus-RTU	
			1000 ppr incremental		
	400 ppr incremental				
	1000 ppr incremental				
2 optoisolated 24 Vdc 500 mA	2 ± 10 Vcc or potentiometer	Serial RS232/485	---	Modbus-RTU	
			---	Modbus-RTU	
2 optoisolated 24 Vdc 500 mA	---	Serial RS232/485	400 ppr incremental	Modbus-RTU	
			1000 ppr incremental		
	400 ppr incremental				
	1000 ppr incremental				
2 optoisolated 24 Vdc 500 mA	2 ± 10 Vcc or potentiometer	Serial RS232/485	---	Modbus-RTU	
			---	Modbus-RTU	

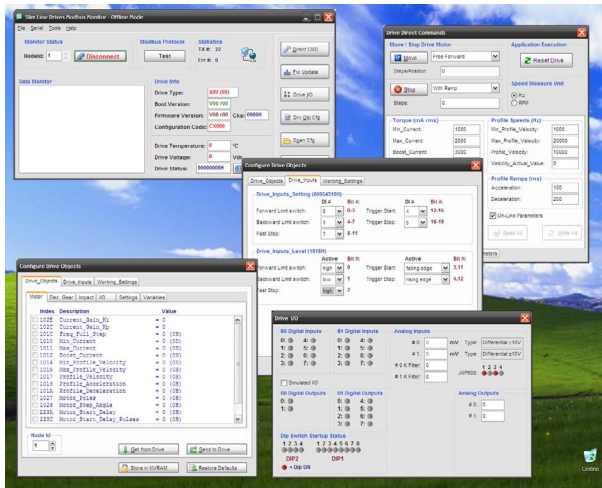

SL - monitor Configuration environment for Slim-Line and SM1A Fieldbus drives

Main features:

- Software tool to configure the SW1 SlimLine and SM1A drives with configuration c0300 and c0400.
- Intuitive and complete screens to insert the application parameters.
- Functions and tools to set the *Advanced Motion Module*.
- Functionality to update the drives' firmware.
- Complete with software tools to debug in a simple and fast way the created application.

Description:

The SlimLine SW and SM1A systems are configured through the SL_CAN and SL_MOD Monitor, software tools for PC Windows, which can be used to develop, configure and monitor every system in a simple and fast way. Through simple windows and wizard, the settings of every drive's working parameters and application is as easy as pie.



SDM - monitor Configuration environment for SD Enhanced and SM2A Fieldbus drives

Main features:

- Software tool to configure the SD Enhanced and SDM drives and the SM2A servomotors with CANbus, Profibus and Serial interface.
- Intuitive and complete screens to insert the application parameters.
- Functions and tools to set the *Advanced Module Motion*.
- Functionality to update the drives' firmware.
- Complete with utility software to quickly and easily debug the created application.
- Calibration and optimization of the parameters for the closed loop function.

Description:

The fieldbus drives of the SD and SM2A series are equipped with PC Windows software tools to develop, configure and monitor the drives as well as the application in an easy and fast way.

The image displays the SDM monitor software interface, which is used for configuring and monitoring SD Enhanced and SM2A fieldbus drives. The interface includes several key windows:

- Monitor Status:** Shows drive information such as Drive Version, Firmware Version, and Motor Parameters.
- Configure Drive Objects:** A table listing drive parameters and their values.

Index	Description	Value
1021	AUTO_Inv_Boost	= 0 (0B)
1010	AUTO_Min_Position	= 0 (0B)
101F	AUTO_Max_Position	= 0 (0B)
102A	Current_Full_Step	= 0 (0B)
101C	Freq_Full_Step	= 0 (0B)
1010	Min_Current	= 0 (0B)
1011	Max_Current	= 0 (0B)
1012	Boost_Current	= 0 (0B)
1013	Nominal_Current	= 0 (0B)
1014	Min_Profile_Velocity	= 0 (0B)
1015	Max_Profile_Velocity	= 0 (0B)
1017	Profile_Velocity	= 0 (0B)
1019	Profile_Acceleration	= 0 (0B)
101A	Profile_Deceleration	= 0 (0B)
1027	Motor_Poles	= 0 (0B)
- Feedback Tuning:** A graph showing real and theoretical feedback signals over time.
- SDM Drive Direct Commands:** A control panel for moving the drive, including buttons for Move, Stop, and Reset, and fields for steps and position.
- Drive Commands Structure Configuration:** A table defining command structures with parameters like speed, acceleration, and deceleration.

#	CMD Code	Parameter #0	Accel.	Decel.	Velocity
0	MOV Free Fw	Variable	1500	400	5000
4	MOV Step Abs	Variable	2000	100	200
2	MOV Target	Variable	# 10	100	200
3	MOV Homing Fw	Variable	0	300	500

The software is shown running on a laptop, which is connected to a SIMATIC 3000 drive unit and a servomotor. A red arrow indicates the connection between the software and the hardware.



**SlimLine
programmables drives**

Main features:

- Integrated PLC
- Multiple Control Modalities
- Programmable with eePLC Studio
- Integrated process modules: Labelling and electronic CAM.
- Equipped with Advanced Security features:
 - ✓ tested for direct unit installation
 - ✓ built-in watchdog function
 - ✓ malfunctions monitoring and handling
 - ✓ separated power supply for logic and power
 - ✓ buffering and on the field management of errors
- Main advantages of the drives:
 - ✓ low motor vibration
 - ✓ low mechanical noise
 - ✓ low heat production
 - ✓ security protections
 - ✓ AC/DC power supply
 - ✓ compact size
 - ✓ no resonance
 - ✓ high reliability
 - ✓ high speed and torque
 - ✓ wide power range

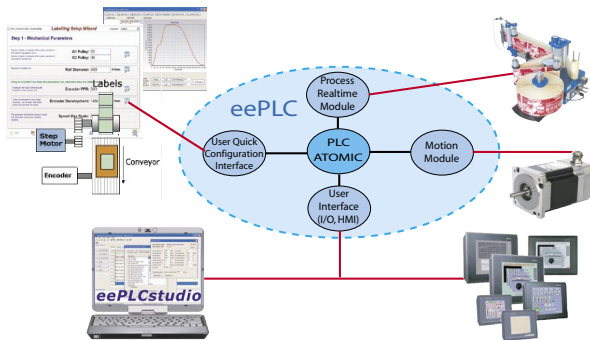

Description:

The SW1 with c0490 and c1490 firmware is a series of Full Digital drives programmable by means of IDE eePLC (Integrated Development Environment) and can also function in 'stand alone' mode allowing a maximal application customization. The series with c1490 firmware integrates also the easy applicable module for full electronic CAM management. This functionality is often requested and leads to significant savings of mechanical references. Additionally to the driving of stepper motors with less noise, less heating, smooth motions and higher performances at high speed, the SW1 drives offer, thanks to the f4d2 firmware, an exceptional reliability combined with mechanical compactness against a competitive cost. Designed for the control of 2 or 4 phase hybrid stepper motors, a wide range of stepper drives with a different power level are available to combine with motor series from 1.7" to 4.2". Thanks to the wizard present in the eePLC development environment, it's simple to design many machine types such as: labellers, X-Y-Z tables, dosing systems, laser applications etc. The drives are suitable to be used in applications that require versatility, accuracy and cost containment.

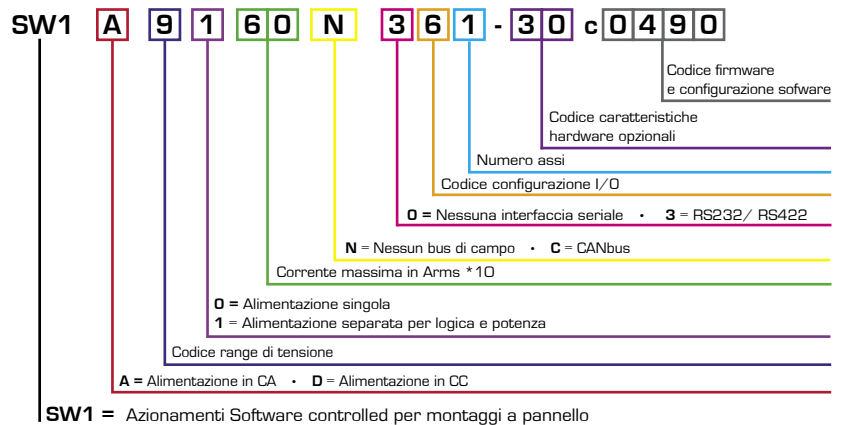

Specifications:

- Power stages:* 40 kHz H-bridge Bipolar chopper.
- Optically isolated inputs:* up to 8 digital optoisolated inputs 5 Vdc line driver or 24 Vdc NPN or PNP(200 khz).
- Optically isolated output:* 8 digital optoisolated output 24 Vdc – 100 mA (700 mA for 170 models).
- Analog Input:* 2± 10 Vdc or for potentiometer.
- Step resolution:* from 1 to 128 micro steps.
- Safety protections:* over/under-voltage, over current, over temperature, open windings, closed windings phase/phase phase/ground.
- Drive Status Monitoring:* seven segments display or 2 status LEDs.
- Temperature:* working temp. 0°C÷50°C, storage temp. 0°C÷55°C.
- Humidity:* 0%÷90%.
- Protection class:* IP20.

Control modalities:

- Stand alone mode
- Velocity Control Modality
- Wide range of Positioning Control Modalities (homing, relative, absolute, target)
- CAM Mode: advanced cam profile can be programmed (c1490 versions)
- Electric Gear with programmable gear ratio to track external master reference (from fieldbus or incremental encoder) of motor Speed and Position
- High speed I/O triggered motor start & stop to event synchronizing for fast response demanding application: labelling, nick_finder, on fly cut., etc .
- Multi Axis movements synchronization capability
- On fly change among any Motion Module Control Modalities
- On fly Electric Gear Enable/Disable capability
- Motor Stall detection & Target Position tracking through encoder feedback

The programming of the application cycle and all hardware resources of the drive is done by means of eePLC Studio IDE, a PC Windows software tool, fast to use and complete with debugging tools. The tool doesn't require the knowledge of any programming language: the macro instructions are inserted by means of guided windows in which the requested parameters must be inserted. It's equipped with wizards to manage the entire labelling head and the electronic CAMs.

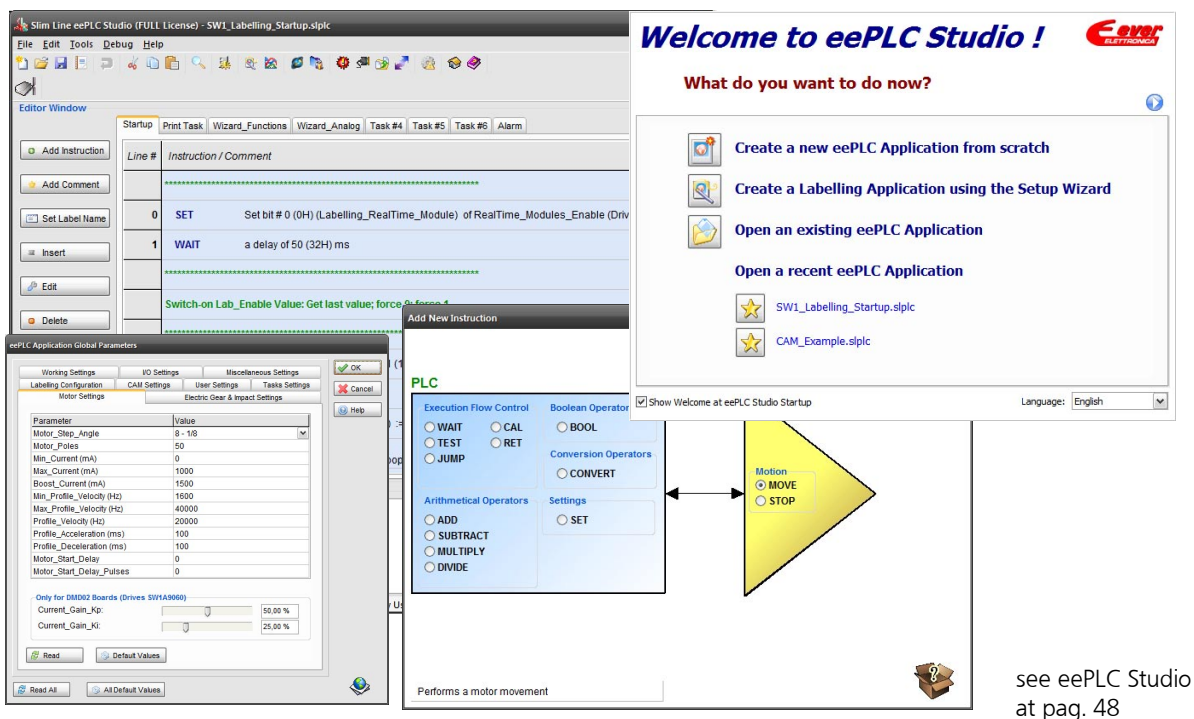

Order code		Power		Current	Digital inputs
Versions	Configurations	Power supply			
		Logic	Power		
2142 Models					
SW1D2142C061-00	c0390	24 ÷ 40 Vdc	24 ÷ 40 Vdc	0 ÷ 4.2 Arms (0 ÷ 6.0 Apeak)	4 optoisolated 200 kHz 5Vdc line driver or 24 Vdc PNP
SW1D2142C061-00	c1390	24 ÷ 40 Vdc	24 ÷ 40 Vdc	0 ÷ 4.2 Arms (0 ÷ 6.0 Apeak)	4 optoisolated 200 kHz 5Vdc line driver or 24 Vdc PNP
SW1D2142N361-00	c0490	24 ÷ 40 Vdc	24 ÷ 40 Vdc	0 ÷ 4.2 Arms (0 ÷ 6.0 Apeak)	4 optoisolated 200 kHz 5Vdc line driver or 24 Vdc PNP
SW1D2142N361-00	c1490	24 ÷ 40 Vdc	24 ÷ 40 Vdc	0 ÷ 4.2 Arms (0 ÷ 6.0 Apeak)	4 optoisolated 200 kHz 5Vdc line driver or 24 Vdc PNP
SW1D2142N361-00	c2490	24 ÷ 40 Vdc	24 ÷ 40 Vdc	0 ÷ 4.2 Arms (0 ÷ 6.0 Apeak)	4 optoisolated 200 kHz 5Vdc line driver or 24 Vdc PNP
3142 Models					
SW1D3142C061-10	c0390	24 ÷ 40 Vdc	24 ÷ 80 Vdc	0 ÷ 4.2 Arms (0 ÷ 6.0 Apeak)	4 optoisolated 200 kHz 5Vdc line driver or 24 Vdc PNP
SW1D3142C061-10	c1390	24 ÷ 40 Vdc	24 ÷ 80 Vdc	0 ÷ 4.2 Arms (0 ÷ 6.0 Apeak)	4 optoisolated 200 kHz 5Vdc line driver or 24 Vdc PNP
SW1D3142N361-10	c0490	24 ÷ 40 Vdc	24 ÷ 80 Vdc	0 ÷ 4.2 Arms (0 ÷ 6.0 Apeak)	4 optoisolated 200 kHz 5Vdc line driver or 24 Vdc PNP
SW1D3142N361-10	c1490	24 ÷ 40 Vdc	24 ÷ 80 Vdc	0 ÷ 4.2 Arms (0 ÷ 6.0 Apeak)	4 optoisolated 200 kHz 5Vdc line driver or 24 Vdc PNP
SW1D3142N361-10	c2490	24 ÷ 40 Vdc	24 ÷ 80 Vdc	0 ÷ 4.2 Arms (0 ÷ 6.0 Apeak)	4 optoisolated 200 kHz 5Vdc line driver or 24 Vdc PNP
4080 Models					
SW1D4080N3B1-00	c0490	24 ÷ 140 Vdc	48 ÷ 140 Vdc	0 ÷ 8.0 Arms (0 ÷ 11.0 Apeak)	16 optoisolated
SW1D4080N3B1-00	c1490	24 ÷ 140 Vdc	48 ÷ 140 Vdc	0 ÷ 8.0 Arms (0 ÷ 11.0 Apeak)	16 optoisolated
SW1D4080N3B1-00	c2490	24 ÷ 140 Vdc	48 ÷ 140 Vdc	0 ÷ 8.0 Arms (0 ÷ 11.0 Apeak)	16 optoisolated
SW1A4080C0B1-00	c0390	17 ÷ 100 Vac	34 ÷ 100 Vac	0 ÷ 8.0 Arms (0 ÷ 11.0 Apeak)	16 optoisolated
SW1A4080C0B1-00	c1390	17 ÷ 100 Vac	34 ÷ 100 Vac	0 ÷ 8.0 Arms (0 ÷ 11.0 Apeak)	16 optoisolated
SW1A4080N3B1-00	c0490	17 ÷ 100 Vac	34 ÷ 100 Vac	0 ÷ 8.0 Arms (0 ÷ 11.0 Apeak)	16 optoisolated
SW1A4080N3B1-00	c1490	17 ÷ 100 Vac	34 ÷ 100 Vac	0 ÷ 8.0 Arms (0 ÷ 11.0 Apeak)	16 optoisolated
SW1A4080N3B1-00	c2490	17 ÷ 100 Vac	34 ÷ 100 Vac	0 ÷ 8.0 Arms (0 ÷ 11.0 Apeak)	16 optoisolated

System resources					Dati meccanici	
Digital outputs	Analog inputs	Analog outputs	Interface	Control	Dimensions	Weight
2 optoisolated 24 Vdc 100 mA	2 ±10Vdc or potentiometer	---	CANbus	Mode eePLC Studio	142.0x74.0x37.0 mm	500 g.
2 optoisolated 24 Vdc 100 mA	2 ±10Vdc or potentiometer	---	CANbus	Mode eePLC Studio with cam management	142.0x74.0x37.0 mm	500 g.
2 optoisolated 24 Vdc 100 mA	2 ±10Vdc or potentiometer	---	Serial RS232/422/485	Mode eePLC Studio	142.0x74.0x37.0 mm	500 g.
2 optoisolated 24 Vdc 100 mA	2 ±10Vdc or potentiometer	---	Serial RS232/422/485	Mode eePLC Studio with cam management	142.0x74.0x37.0 mm	500 g.
2 optoisolated 24 Vdc 100 mA	2 ±10Vdc or potentiometer	---	Serial RS232/422/485	Mode eePLC Studio with Labelling Premium	142.0x74.0x37.0 mm	500 g.
2 optoisolated 24 Vdc 100 mA	2 ±10Vdc or potentiometer	---	CANbus	Mode eePLC Studio	142.0x74.0x37.0 mm	500 g.
2 optoisolated 24 Vdc 100 mA	2 ±10Vdc or potentiometer	---	CANbus	Mode eePLC Studio with cam management	142.0x74.0x37.0 mm	500 g.
2 optoisolated 24 Vdc 100 mA	2 ±10Vdc or potentiometer	---	Serial RS232/422/485	Mode eePLC Studio	142.0x74.0x37.0 mm	500 g.
2 optoisolated 24 Vdc 100 mA	2 ±10Vdc or potentiometer	---	Serial RS232/422/485	Mode eePLC Studio with cam management	142.0x74.0x37.0 mm	500 g.
2 optoisolated 24 Vdc 100 mA	2 ±10Vdc or potentiometer	---	Serial RS232/422/485	Mode eePLC Studio with Labelling Premium	142.0x74.0x37.0 mm	500 g.
10 optoisolated 24Vdc 100 mA (2) and 300 mA (8)	2 ±10Vdc or potentiometer	---	Serial RS232/422/485	Mode eePLC Studio	165.0x97.5x54.3 mm	720 g.
10 optoisolated 24Vdc 100 mA (2) and 300 mA (8)	2 ±10Vdc or potentiometer	---	Serial RS232/422/485	Mode eePLC Studio with cam management	165.0x97.5x54.3 mm	720 g.
10 optoisolated 24Vdc 100 mA (2) and 300 mA (8)	2 ±10Vdc or potentiometer	---	Serial RS232/422/485	Mode eePLC Studio with Labelling Premium	165.0x97.5x54.3 mm	720 g.
10 optoisolated 24Vdc 100 mA (2) and 300 mA (8)	2 ±10Vdc or potentiometer	---	CANbus	Mode eePLC Studio	165.0x97.5x62.3 mm	900 g.
10 optoisolated 24Vdc 100 mA (2) and 300 mA (8)	2 ±10Vdc or potentiometer	---	CANbus	Mode eePLC Studio with cam management	165.0x97.5x62.3 mm	900 g.
10 optoisolated 24Vdc 100 mA (2) and 300 mA (8)	2 ±10Vdc or potentiometer	---	Serial RS232/422/485	Mode eePLC Studio	165.0x97.5x62.3 mm	900 g.
10 optoisolated 24Vdc 100 mA (2) and 300 mA (8)	2 ±10Vdc or potentiometer	---	Serial RS232/422/485	Mode eePLC Studio with cam management	165.0x97.5x62.3 mm	900 g.
10 optoisolated 24Vdc 100 mA (2) and 300 mA (8)	2 ±10Vdc or potentiometer	---	Serial RS232/422/485	Mode eePLC Studio with Labelling Premium	165.0x97.5x62.3 mm	900 g.

Order code		Power		Current	Digital inputs
Versions	Configurations	Power supply			
		Logic	Power		
4085 Models					
SW1D4085C061-00	c0390	24 ÷ 140 Vdc	24 ÷ 140 Vdc	0 ÷ 8.5 Arms (0 ÷ 12.0 Apeak)	4 optoisolated 200 kHz 2 ÷ 5Vdc line driver or 11 ÷ 24 Vdc PNP
SW1D4085C061-00	c1390	24 ÷ 140 Vdc	24 ÷ 140 Vdc	0 ÷ 8.5 Arms (0 ÷ 12.0 Apeak)	4 optoisolated 200 kHz 2 ÷ 5Vdc line driver or 11 ÷ 24 Vdc PNP
SW1D4085N361-00	c0490	24 ÷ 140 Vdc	24 ÷ 140 Vdc	0 ÷ 8.5 Arms (0 ÷ 12.0 Apeak)	4 optoisolated 200 kHz 2 ÷ 5Vdc line driver or 11 ÷ 24 Vdc PNP
SW1D4085N361-00	c1490	24 ÷ 140 Vdc	24 ÷ 140 Vdc	0 ÷ 8.5 Arms (0 ÷ 12.0 Apeak)	4 optoisolated 200 kHz 2 ÷ 5Vdc line driver or 11 ÷ 24 Vdc PNP
SW1D4085N361-00	c2490	24 ÷ 140 Vdc	24 ÷ 140 Vdc	0 ÷ 8.5 Arms (0 ÷ 12.0 Apeak)	4 optoisolated 200 kHz 2 ÷ 5Vdc line driver or 11 ÷ 24 Vdc PNP
SW1A4085C061-00	c0390	17 ÷ 100 Vac	17 ÷ 100 Vac	0 ÷ 8.5 Arms (0 ÷ 12.0 Apeak)	4 optoisolated 200 kHz 2 ÷ 5Vdc line driver or 11 ÷ 24 Vdc PNP
SW1A4085C061-00	c1390	17 ÷ 100 Vac	17 ÷ 100 Vac	0 ÷ 8.5 Arms (0 ÷ 12.0 Apeak)	4 optoisolated 200 kHz 2 ÷ 5Vdc line driver or 11 ÷ 24 Vdc PNP
SW1A4085N361-00	c0490	17 ÷ 100 Vac	17 ÷ 100 Vac	0 ÷ 8.5 Arms (0 ÷ 12.0 Apeak)	4 optoisolated 200 kHz 2 ÷ 5Vdc line driver or 11 ÷ 24 Vdc PNP
SW1A4085N361-00	c1490	17 ÷ 100 Vac	17 ÷ 100 Vac	0 ÷ 8.5 Arms (0 ÷ 12.0 Apeak)	4 optoisolated 200 kHz 2 ÷ 5Vdc line driver or 11 ÷ 24 Vdc PNP
SW1A4085N361-00	c2490	17 ÷ 100 Vac	17 ÷ 100 Vac	0 ÷ 8.5 Arms (0 ÷ 12.0 Apeak)	4 optoisolated 200 kHz 2 ÷ 5Vdc line driver or 11 ÷ 24 Vdc PNP
9060 Models					
SW1A9060C061-00	c0390	Single 115 ÷ 230 Vac		0 ÷ 6.0 Arms (0 ÷ 8.46 Apeak)	4 optoisolated 200 kHz 5Vdc line driver or 24 Vdc PNP
SW1A9060C061-00	c1390	Single 115 ÷ 230 Vac		0 ÷ 6.0 Arms (0 ÷ 8.46 Apeak)	4 optoisolated 200 kHz 5Vdc line driver or 24 Vdc PNP
SW1A9060C0C1-00	c0390	Single 115 ÷ 230 Vac		0 ÷ 6.0 Arms (0 ÷ 8.46 Apeak)	16 optoisolated
SW1A9060C0C1-00	c1390	Single 115 ÷ 230 Vac		0 ÷ 6.0 Arms (0 ÷ 8.46 Apeak)	16 optoisolated
SW1A9060N361-00	c0490	Single 115 ÷ 230 Vac		0 ÷ 6.0 Arms (0 ÷ 8.46 Apeak)	4 optoisolated 200 kHz 5Vdc line driver or 24 Vdc PNP
SW1A9060N361-00	c1490	Single 115 ÷ 230 Vac		0 ÷ 6.0 Arms (0 ÷ 8.46 Apeak)	4 optoisolated 200 kHz 5Vdc line driver or 24 Vdc PNP
SW1A9060N361-00	c2490	Single 115 ÷ 230 Vac		0 ÷ 6.0 Arms (0 ÷ 8.46 Apeak)	4 optoisolated 200 kHz 5Vdc line driver or 24 Vdc PNP
SW1A9060N3C1-00	c0490	Single 115 ÷ 230 Vac		0 ÷ 6.0 Arms (0 ÷ 8.46 Apeak)	16 optoisolated
SW1A9060N3C1-00	c1490	Single 115 ÷ 230 Vac		0 ÷ 6.0 Arms (0 ÷ 8.46 Apeak)	16 optoisolated
SW1A9060N3C1-00	c2490	Single 115 ÷ 230 Vac		0 ÷ 6.0 Arms (0 ÷ 8.46 Apeak)	16 optoisolated
9160 Models					
SW1A9160C061-00	c0390	115 ÷ 230 Vac	115 ÷ 230 Vac	0 ÷ 6.0 Arms (0 ÷ 8.46 Apeak)	4 optoisolated 200 kHz 5Vdc line driver or 24 Vdc PNP
SW1A9160C061-00	c1390	115 ÷ 230 Vac	115 ÷ 230 Vac	0 ÷ 6.0 Arms (0 ÷ 8.46 Apeak)	4 optoisolated 200 kHz 5Vdc line driver or 24 Vdc PNP
SW1A9160C0C1-00	c0390	115 ÷ 230 Vac	115 ÷ 230 Vac	0 ÷ 6.0 Arms (0 ÷ 8.46 Apeak)	16 optoisolated
SW1A9160C0C1-00	c1390	115 ÷ 230 Vac	115 ÷ 230 Vac	0 ÷ 6.0 Arms (0 ÷ 8.46 Apeak)	16 optoisolated
SW1A9160N361-00	c0490	115 ÷ 230 Vac	115 ÷ 230 Vac	0 ÷ 6.0 Arms (0 ÷ 8.46 Apeak)	4 optoisolated 200 kHz 5Vdc line driver or 24 Vdc PNP
SW1A9160C0C1-00	c1490	115 ÷ 230 Vac	115 ÷ 230 Vac	0 ÷ 6.0 Arms (0 ÷ 8.46 Apeak)	4 optoisolated 200 kHz 5Vdc line driver or 24 Vdc PNP
SW1A9160C0C1-00	c2490	115 ÷ 230 Vac	115 ÷ 230 Vac	0 ÷ 6.0 Arms (0 ÷ 8.46 Apeak)	4 optoisolated 200 kHz 5Vdc line driver or 24 Vdc PNP
SW1A9160N3C1-00	c0490	115 ÷ 230 Vac	115 ÷ 230 Vac	0 ÷ 6.0 Arms (0 ÷ 8.46 Apeak)	16 optoisolated
SW1A9160N3C1-00	c1490	115 ÷ 230 Vac	115 ÷ 230 Vac	0 ÷ 6.0 Arms (0 ÷ 8.46 Apeak)	16 optoisolated
SW1A9160N3C1-00	c2490	115 ÷ 230 Vac	115 ÷ 230 Vac	0 ÷ 6.0 Arms (0 ÷ 8.46 Apeak)	16 optoisolated

System resources					Dati meccanici	
Digital outputs	Analog inputs	Analog outputs	Interface	Control	Dimensions	Weight
2 optoisolated 24 Vdc 100 mA	2 ±10Vdc or potentiometer	---	CANbus	Mode eePLC Studio	165.0x108.0x49.0 mm	800 g.
2 optoisolated 24 Vdc 100 mA	2 ±10Vdc or potentiometer	---	CANbus	Mode eePLC Studio with cam management	165.0x108.0x49.0 mm	800 g.
2 optoisolated 24 Vdc 100 mA	2 ±10Vdc or potentiometer	---	Serial RS232/422/485	Mode eePLC Studio	165.0x108.0x49.0 mm	800 g.
2 optoisolated 24 Vdc 100 mA	2 ±10Vdc or potentiometer	---	Serial RS232/422/485	Mode eePLC Studio with cam management	165.0x108.0x49.0 mm	800 g.
2 optoisolated 24 Vdc 100 mA	2 ±10Vdc or potentiometer	---	Serial RS232/422/485	Mode eePLC Studio with Labelling Premium	165.0x108.0x49.0 mm	800 g.
2 optoisolated 24 Vdc 100 mA	2 ±10Vdc or potentiometer	---	CANbus	Mode eePLC Studio	165.0x108.0x49.0 mm	800 g.
2 optoisolated 24 Vdc 100 mA	2 ±10Vdc or potentiometer	---	CANbus	Mode eePLC Studio with cam management	165.0x108.0x49.0 mm	800 g.
2 optoisolated 24 Vdc 100 mA	2 ±10Vdc or potentiometer	---	Serial RS232/422/485	Mode eePLC Studio	165.0x108.0x49.0 mm	800 g.
2 optoisolated 24 Vdc 100 mA	2 ±10Vdc or potentiometer	---	Serial RS232/422/485	Mode eePLC Studio with cam management	165.0x108.0x49.0 mm	800 g.
2 optoisolated 24 Vdc 100 mA	2 ±10Vdc or potentiometer	---	Serial RS232/422/485	Mode eePLC Studio with Labelling Premium	165.0x108.0x49.0 mm	800 g.
2 optoisolated 24 Vdc 100 mA	2 ±10Vdc or potentiometer	---	CANbus	Mode eePLC Studio	235.0x151.5x62.5 mm	1400 g.
2 optoisolated 24 Vdc 100 mA	2 ±10Vdc or potentiometer	---	CANbus	Mode eePLC Studio with cam management	235.0x151.5x62.5 mm	1400 g.
10 optoisolated 24Vdc 100 mA (2) and 300 mA (8)	2 ±10Vdc or potentiometer	---	CANbus	Mode eePLC Studio	235.0x151.5x62.5 mm	1400 g.
10 optoisolated 24Vdc 100 mA (2) and 300 mA (8)	2 ±10Vdc or potentiometer	---	CANbus	Mode eePLC Studio with cam management	235.0x151.5x62.5 mm	1400 g.
2 optoisolated 24 Vdc 100 mA	2 ±10Vdc or potentiometer	---	Serial RS232/422/485	Mode eePLC Studio	235.0x151.5x62.5 mm	1400 g.
2 optoisolated 24 Vdc 100 mA	2 ±10Vdc or potentiometer	---	Serial RS232/422/485	Mode eePLC Studio with cam management	235.0x151.5x62.5 mm	1400 g.
2 optoisolated 24 Vdc 100 mA	2 ±10Vdc or potentiometer	---	Serial RS232/422/485	Mode eePLC Studio with Labelling Premium	235.0x151.5x62.5 mm	1400 g.
10 optoisolated 24Vdc 100 mA (2) and 300 mA (8)	2 ±10Vdc or potentiometer	---	Serial RS232/422/485	Mode eePLC Studio	235.0x151.5x62.5 mm	1400 g.
10 optoisolated 24Vdc 100 mA (2) and 300 mA (8)	2 ±10Vdc or potentiometer	---	Serial RS232/422/485	Mode eePLC Studio with cam management	235.0x151.5x62.5 mm	1400 g.
10 optoisolated 24Vdc 100 mA (2) and 300 mA (8)	2 ±10Vdc or potentiometer	---	Serial RS232/422/485	Mode eePLC Studio with Labelling Premium	235.0x151.5x62.5 mm	1400 g.
2 optoisolated 24 Vdc 100 mA	2 ±10Vdc or potentiometer	---	CANbus	Mode eePLC Studio	235.0x151.5x62.5 mm	1400 g.
2 optoisolated 24 Vdc 100 mA	2 ±10Vdc or potentiometer	---	CANbus	Mode eePLC Studio with cam management	235.0x151.5x62.5 mm	1400 g.
10 optoisolated 24Vdc 100 mA (2) and 300 mA (8)	2 ±10Vdc or potentiometer	---	CANbus	Mode eePLC Studio	235.0x151.5x62.5 mm	1400 g.
10 optoisolated 24Vdc 100 mA (2) and 300 mA (8)	2 ±10Vdc or potentiometer	---	CANbus	Mode eePLC Studio with cam management	235.0x151.5x62.5 mm	1400 g.
2 optoisolated 24 Vdc 100 mA	2 ±10Vdc or potentiometer	---	Serial RS232/422/485	Mode eePLC Studio	235.0x151.5x62.5 mm	1400 g.
2 optoisolated 24 Vdc 100 mA	2 ±10Vdc or potentiometer	2 ±10Vdc	Serial RS232/422/485	Mode eePLC Studio with cam management	235.0x151.5x62.5 mm	1400 g.
2 optoisolated 24 Vdc 100 mA	2 ±10Vdc or potentiometer	2 ±10Vdc	Serial RS232/422/485	Mode eePLC Studio with Labelling Premium	235.0x151.5x62.5 mm	1400 g.
10 optoisolated 24Vdc 100 mA (2) and 300 mA (8)	2 ±10Vdc or potentiometer	2 ±10Vdc	Serial RS232/422/485	Mode eePLC Studio	235.0x151.5x62.5 mm	1400 g.
10 optoisolated 24Vdc 100 mA (2) and 300 mA (8)	2 ±10Vdc or potentiometer	2 ±10Vdc	Serial RS232/422/485	Mode eePLC Studio with cam management	235.0x151.5x62.5 mm	1400 g.
10 optoisolated 24Vdc 100 mA (2) and 300 mA (8)	2 ±10Vdc or potentiometer	2 ±10Vdc	Serial RS232/422/485	Mode eePLC Studio with Labelling Premium	235.0x151.5x62.5 mm	1400 g.

Enhanced drives



Main features:

- Integrated PLC.
- Multiform control modalities
- On board safety provisions:
 - √ fully tested for direct installation unit
 - √ built in watch dog functionality
 - √ fault monitoring and handling
 - √ on field working errors buffering
- Main advantages of the drives:
 - √ low motor vibration
 - √ low mechanical noise
 - √ low heat generation
 - √ closed loop of torque, velocity and position
 - √ energy saving
 - √ no resonance
 - √ high reliability
 - √ DC/AC power supply
 - √ wide range of power

Description:

The SDM programmable drives series with c0499 firmware, are Full Digital micro-step devices with local intelligence and high performances, based on the precise pwm control technology for the regulation of the sinusoidal current inserted in the f⁴d² technology and easy to program by means of Atomic IDE. With the SDM drives it's possible to control 2 or 4 phase stepper motors in **open as well as in closed loop of torque, velocity and position**, with less noise, less heating, smooth motions and energy saving. A wide range of SDM stepper drives with a different power level are available to combine with motor series with a flange size from 1.7" to 4.2". The SDM drives with c0499 firmware offer a maximal versatility and reliability to a **variety of applications** and enable the fast and easy designing and testing of customized solutions. Thanks to the hardware resources available in the various drive versions and the advanced Control Modality implementations in the real time power module, such as electronic CAM profile programming, these drives together with the c0499 firmware and the Atomic IDE interface can also fully execute the **PLC functions**.

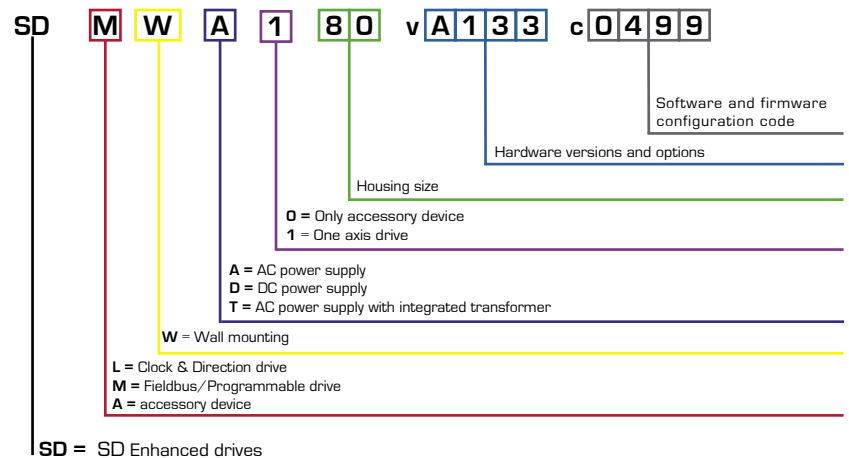

Specifications:

Power stages: 40 kHz H-bridge Bipolar chopper.

Optoisolated control busses: CANbus, Profibus or Serial.

Optically isolated inputs: up to 8 digital.

Optically isolated output: up to 8 digital.

Step resolution: from 1 to 128 micro steps(open loop) / StepLess technology (closed loop).

Safety protections: over/under-voltage, over current, over temperature, open windings, closed windings phase/phase phase/ground.

Drive Status Monitoring: seven segments led display.

Temperature: working temp. 0°C+50°C, storage temp. 0°C+55°C.

Humidity: 0%+90%.

Protection class: IP20.

Control modalities:

- Stand alone mode'
- Velocity Control Modality
- Wide range of Positioning Control modalities (homing, relative, absolute, target)
- Electric Gear with programmable gear ratio to track external master reference (from fieldbus or incremental encoder) of motor Speed and Position
- High speed I/O triggered motor start & stop to event synchronizing for fast response demanding application: labeling, nick_finder, on fly cut., etc ...
- Multi Axis movements synchronization capability
- On fly change among any Motion Module Control modalities
- On fly Electric Gear Enable/Disable capability
- Motor Stall detection & Target Position tracking through encoder feedback

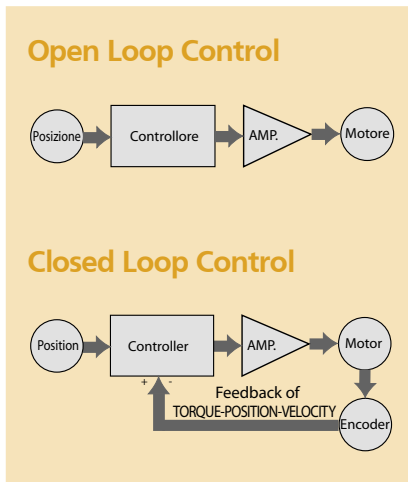

- Advantages of Closed Loop Control:
 - with regard to an Open Loop Stepper Solution:
 - reliable positioning without synchronism loss;
 - keeps the original position stable and recovers it automatically in case of positioning errors caused by external factors such as mechanical vibrations;
 - 100% use of the motor torque;
 - capacity to operate at high velocity related to the current control, which is adjusted depending on the load variations, where the normal systems in open loop use a constant current control at all velocities without considering the load variations.
 - compared with a brushless servo controlled solution:
 - no need to adjust the power (automatic current regulation depending on the load changes);
 - keeping the position stable without fluctuations after completing the positioning;
 - quick positioning favoured by the independent control of the integrated DSP;
 - continuous and fast execution of short stroke movements thanks to the short positioning time.

The programming of the application cycle and all hardware resources of the drive is done by means of Atomic IDE, a PC Windows software tool, fast to use and complete with debugging tools. The tool doesn't require the knowledge of any programming language: the macro instructions are inserted by means of guided windows in which the requested parameters must be inserted.

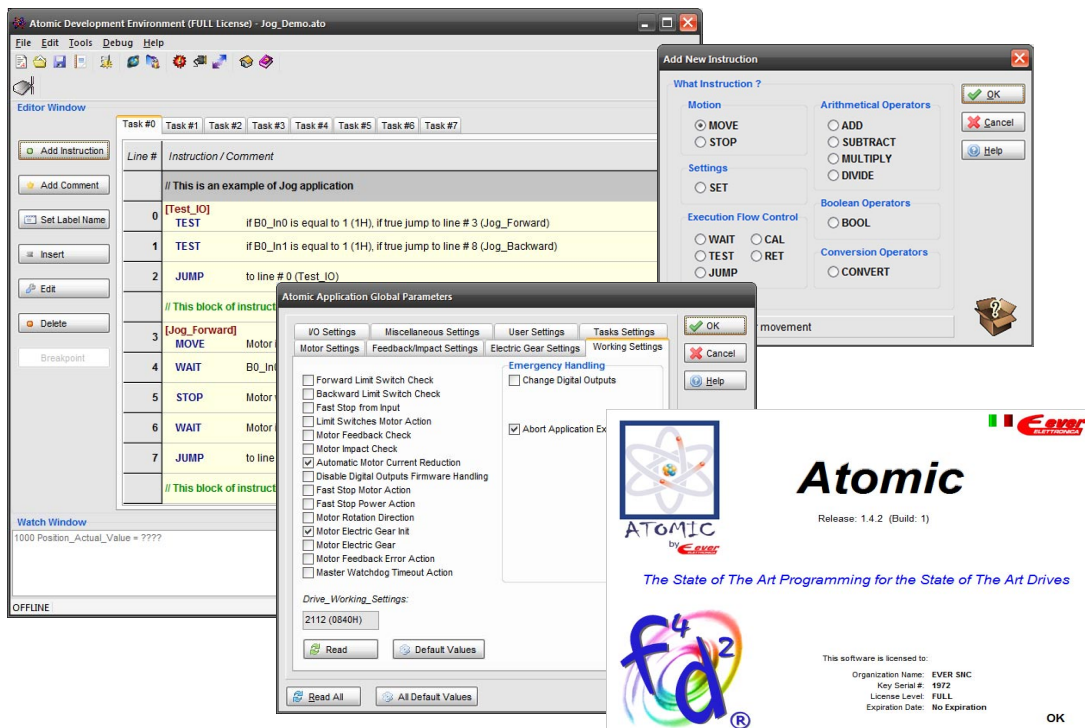

see Atomic at pag. 49

Order code		Power		Current	Digital inputs
Versions	Configurations	Power supply			
		Logic	Power		
170 Models					
SDMWD170vB231	c0499	24 ÷ 140 Vdc	24 ÷ 140 Vdc	1.0 ÷ 8.0 Arms (1.4 ÷ 11.2 Apeak)	4 optoisolated 200 kHz 5 Vdc line driver or 24 Vdc PNP
SDMWD170vB242	c0499	24 ÷ 140 Vdc	24 ÷ 140 Vdc	1.0 ÷ 8.0 Arms (1.4 ÷ 11.2 Apeak)	8 optoisolated 200 kHz 5 Vdc line driver or 24 Vdc PNP
SDMWA170v2231	c0499	24 ÷ 90 Vac	24 ÷ 90 Vac	1.0 ÷ 8.0 Arms (1.4 ÷ 11.2 Apeak)	4 optoisolated 200 kHz 5 Vdc line driver or 24 Vdc PNP
SDMWA170v2242	c0499	24 ÷ 90 Vac	24 ÷ 90 Vac	1.0 ÷ 8.0 Arms (1.4 ÷ 11.2 Apeak)	8 optoisolated 200 kHz 5 Vdc line driver or 24 Vdc PNP
SDMWA170v4231	c0499	18 Vac (24 Vdc user output)	24 ÷ 90 Vac	1.0 ÷ 8.0 Arms (1.4 ÷ 11.2 Apeak)	4 optoisolated 200 kHz 5 Vdc line driver or 24 Vdc PNP
SDMWA170v4242	c0499	18 Vac (24 Vdc user output)	24 ÷ 90 Vac	1.0 ÷ 8.0 Arms (1.4 ÷ 11.2 Apeak)	8 optoisolated 200 kHz 5 Vdc line driver or 24 Vdc PNP
180 Models					
SDMWD180vA133	c0499	24 ÷ 70 Vdc		0.5 ÷ 5.0 Arms (0.7 ÷ 7.0 Apeak)	4 optoisolated 200 kHz 5 Vdc line driver or 24 Vdc PNP
SDMWA180vA133	c0499	24 ÷ 48 Vac		0.5 ÷ 5.0 Arms (0.7 ÷ 7.0 Apeak)	4 optoisolated 200 kHz 5 Vdc line driver or 24 Vdc PNP
SDMWT180vA133	c0499	115 ÷ 230 Vac		0.5 ÷ 5.0 Arms (0.7 ÷ 7.0 Apeak)	4 optoisolated 200 kHz 5 Vdc line driver or 24 Vdc PNP

* = CANbus interface activated only with customized firmware

System resources				Mechanical data	
Digital outputs	Analog inputs	Interface	Control	Dimensions	Weight
4 optoisolated 24 Vdc 500 mA	1 ±10 Vdc or potentiometer	Serial RS232/422/485	Mode Atomic	175.0x47.7x123.3 mm	770 g.
8 optoisolated 24 Vdc 500 mA	1 ±10 Vdc or potentiometer	Serial RS232/422/485 CANbus*	Mode Atomic	175.0x47.7x123.3 mm	770 g.
4 optoisolated 24 Vdc 500 mA	1 ±10 Vdc or potentiometer	Serial RS232/422/485	Mode Atomic	175.0x88.3x123.3 mm	800 g.
8 optoisolated 24 Vdc 500 mA	1 ±10 Vdc or potentiometer	Serial RS232/422/485 CANbus*	Mode Atomic	175.0x88.3x123.3 mm	800 g.
4 optoisolated 24 Vdc 500 mA	1 ±10 Vdc or potentiometer	Serial RS232/422/485	Mode Atomic	175.0x88.3x123.3 mm	800 g.
8 optoisolated 24 Vdc 500 mA	1 ±10 Vdc or potentiometer	Serial RS232/422/485 CANbus*	Mode Atomic	175.0x88.3x123.3 mm	800 g.
3 optoisolated 24 Vdc 100 mA	2 ±10 Vdc or potentiometer	Serial RS232/422/485	Mode Atomic	175.0x47.7x123.3 mm	680 g.
3 optoisolated 24 Vdc 100 mA	2 ±10 Vdc or potentiometer	Serial RS232/422/485	Mode Atomic	175.0x47.7x123.3 mm	810 g.
3 optoisolated 24 Vdc 100 mA	2 ±10 Vdc or potentiometer	Serial RS232/422/485	Mode Atomic	175.0x118.6x124.3 mm	1500 g.



SM1A Programmable Drive, 60 mm Motor and Encoder in one device

Main features:

- Integrated PLC
- Multifunction Control modalities
- On Board Safety provisions:
 - ✓ fully tested for direct installation unit
 - ✓ built in watch dog functionality
 - ✓ fault monitoring and handling
 - ✓ on field working errors buffering
 - ✓ separated power supply for logic and power

Description:

The programmable drives with integrated motor of the **SM1A** series with c0490, c1490 or c2490 firmware are high performance devices, consisting of a Full Digital drive based on the precise pwm technology embedded in the f⁴d² firmware to control the sinusoidal current, a 50 poles high torque motor and an optional encoder for motor stall detection & target position tracking with less noise, less heating, smooth motions and energy saving. The SM1A units are programmable by the user by means of the PC Windows environment eePLC Studio, and are available in a wide power range with 2.4" flange (60 mm) motors. Besides compactness and power, the SM1A series offers maximum versatility and reliability, and a remarkable saving of wiring and electrical switchboards. By programming the motor movements and hardware resources which are available in different versions, and having at your disposal the advanced Control Modality implementations in the real time power module, you can drive your own application fast and easy.

- Main advantages:
 - ✓ low motor vibration
 - ✓ low mechanical noise
 - ✓ low heat production
 - ✓ AC power supply
 - ✓ protection class IP65
 - ✓ no resonance
 - ✓ high reliability
 - ✓ wide range of power

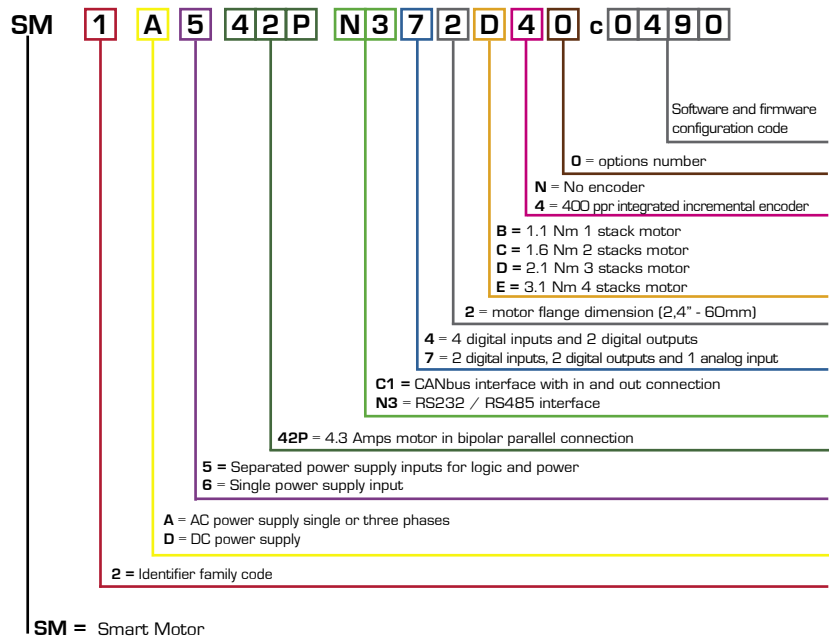

Specifications:

- Torque:* 1.1 Nm, 1.65 Nm, 2.1 Nm and 3.1 Nm motors.
- Optoisolated control bus:* CANBus and Serial.
- Optoisolated communication bus:* CANbus and Serial.
- Power stage:* 40 kHz H-bridge bipolar chopper.
- Optoisolated inputs:* 4 digital.
- Optoisolated outputs:* 2 digital.
- Analog input:* 1 ±10 Vdc or potentiometer.
- Step resolution:* from 1 to 128 microsteps.
- Step resolution:* from 1 to 128 microsteps.
- Safety protection:* Over/Under-voltage, Over Current, Over Temperature, Open Windings, Closed Windings Phase/Phase and Phase/Ground.
- Temperature:* working temp. 0°C+50°C, storage temp. 0°C+55°C.
- Humidity:* 0%+90%.
- Protection class:* IP65.

Control modalities:

- Stand alone mode
- Velocity Control Modality
- Wide range of Positioning Control modalities (homing, relative, absolute, target)
- CAM mode: advanced cam profile can be programmed (c1490 versions)
- Electric Gear with programmable gear ratio to track external master reference (from fieldbus or incremental encoder) of motor Speed and Position
- High speed I/O triggered motor start & stop to event synchronizing for fast response demanding application: labeling, nick_finder, on fly cut, etc ...
- Multi Axis movements synchronization capability
- On fly change among any Motion Module Control modalities
- On fly Electric Gear Enable/Disable capability
- Motor Stall detection & Target Position tracking through encoder feedback

The programming of the application cycle and all hardware resources of the drive is done by means of eePLC Studio IDE, a PC Windows software tool, fast to use and complete with debugging tools. The tool doesn't require the knowledge of any programming language: the macro instructions are inserted by means of guided windows in which the requested parameters must be inserted. It's equipped with wizards to manage the entire labelling head and the electronic CAMs.

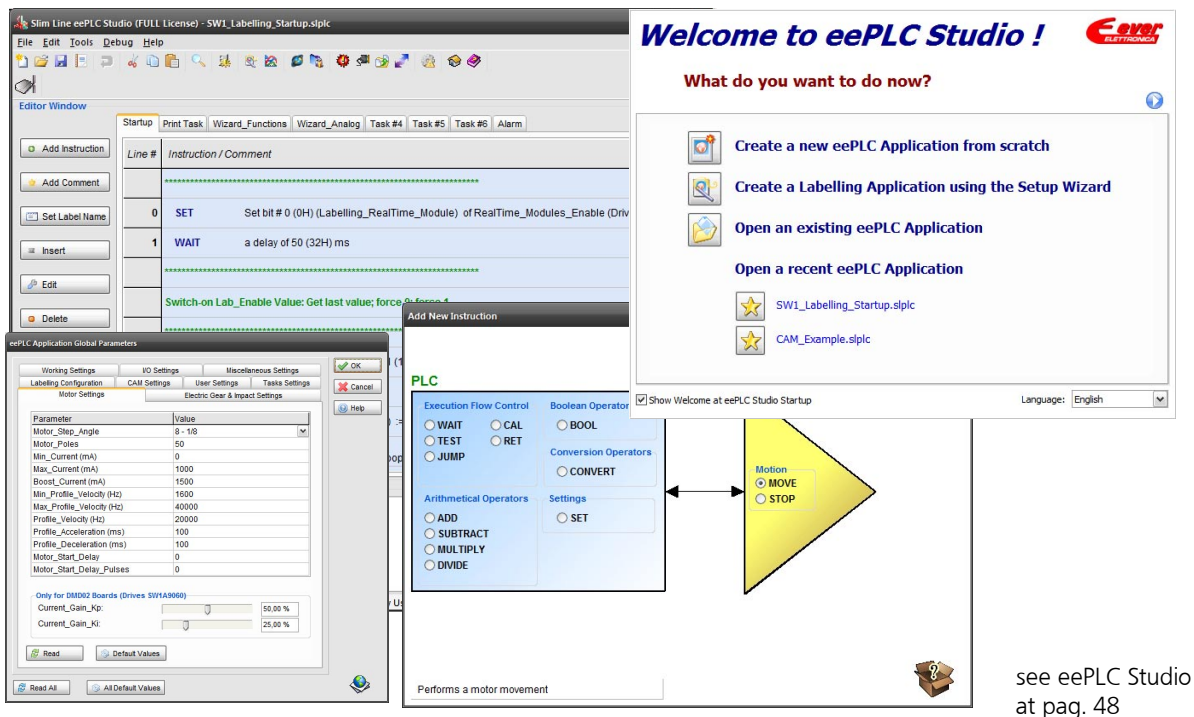

see eePLC Studio at pag. 48

Order code		Power			Motor	Digital inputs	
Versions	Configurations	Power supply		Current			
		Logic	Power				
SM1A542PC142_40	c0390	24 Vdc	18 ÷ 48 Vac	0 ÷ 4.2 Arms (0 ÷ 6.0 Apeak)	B Holding torque 1.10 Nm±10% Phase resistance 0.44 ohm ±10% Phase inductance 2.54 mH ±10% Detent torque 0.05 Nm Rotor inertia 275 g.cm ²	4 optoisolated 200kHz 24Vdc	
SM1A542PC142_40	c1390	24 Vdc	18 ÷ 48 Vac	0 ÷ 4.2 Arms (0 ÷ 6.0 Apeak)		4 optoisolated 200kHz 24Vdc	
SM1A542PC142_NO	c0390	24 Vdc	18 ÷ 48 Vac	0 ÷ 4.2 Arms (0 ÷ 6.0 Apeak)		4 optoisolated 200kHz 24Vdc	
SM1A542PC142_NO	c1390	24 Vdc	18 ÷ 48 Vac	0 ÷ 4.2 Arms (0 ÷ 6.0 Apeak)		4 optoisolated 200kHz 24Vdc	
SM1A542PC172_40	c0390	24 Vdc	18 ÷ 48 Vac	0 ÷ 4.2 Arms (0 ÷ 6.0 Apeak)		4 optoisolated 200kHz 24Vdc	
SM1A542PC172_40	c1390	24 Vdc	18 ÷ 48 Vac	0 ÷ 4.2 Arms (0 ÷ 6.0 Apeak)		4 optoisolated 200kHz 24Vdc	
SM1A542PC172_NO	c0390	24 Vdc	18 ÷ 48 Vac	0 ÷ 4.2 Arms (0 ÷ 6.0 Apeak)		4 optoisolated 200kHz 24Vdc	
SM1A542PC172_NO	c1390	24 Vdc	18 ÷ 48 Vac	0 ÷ 4.2 Arms (0 ÷ 6.0 Apeak)		4 optoisolated 200kHz 24Vdc	
SM1A642PC142_40	c0390	Single 18 ÷ 48 Vac		0 ÷ 4.2 Arms (0 ÷ 6.0 Apeak)		4 optoisolated 200kHz 24Vdc	
SM1A642PC142_40	c1390	Single 18 ÷ 48 Vac		0 ÷ 4.2 Arms (0 ÷ 6.0 Apeak)		4 optoisolated 200kHz 24Vdc	
SM1A642PC142_NO	c0390	Single 18 ÷ 48 Vac		0 ÷ 4.2 Arms (0 ÷ 6.0 Apeak)		4 optoisolated 200kHz 24Vdc	
SM1A642PC142_NO	c1390	Single 18 ÷ 48 Vac		0 ÷ 4.2 Arms (0 ÷ 6.0 Apeak)		4 optoisolated 200kHz 24Vdc	
SM1A642PC172_40	c0390	Single 18 ÷ 48 Vac		0 ÷ 4.2 Arms (0 ÷ 6.0 Apeak)		4 optoisolated 200kHz 24Vdc	
SM1A642PC172_40	c1390	Single 18 ÷ 48 Vac		0 ÷ 4.2 Arms (0 ÷ 6.0 Apeak)		4 optoisolated 200kHz 24Vdc	
SM1A642PC172_NO	c0390	Single 18 ÷ 48 Vac		0 ÷ 4.2 Arms (0 ÷ 6.0 Apeak)		4 optoisolated 200kHz 24Vdc	
SM1A642PC172_NO	c1390	Single 18 ÷ 48 Vac		0 ÷ 4.2 Arms (0 ÷ 6.0 Apeak)		4 optoisolated 200kHz 24Vdc	
SM1A542PN342_40	c0490	24 Vdc	18 ÷ 48 Vac	0 ÷ 4.2 Arms (0 ÷ 6.0 Apeak)		C Holding torque 1.65 Nm±10% Phase resistance 0.19 ohm ±10% Phase inductance 1.70 mH ±10% Detent torque 0.07 Nm Rotor inertia 300 g.cm ²	4 optoisolated 200kHz 24Vdc
SM1A542PN342_40	c1490	24 Vdc	18 ÷ 48 Vac	0 ÷ 4.2 Arms (0 ÷ 6.0 Apeak)			4 optoisolated 200kHz 24Vdc
SM1A542PN342_40	c2490	24 Vdc	18 ÷ 48 Vac	0 ÷ 4.2 Arms (0 ÷ 6.0 Apeak)			4 optoisolated 200kHz 24Vdc
SM1A542PN342_NO	c0490	24 Vdc	18 ÷ 48 Vac	0 ÷ 4.2 Arms (0 ÷ 6.0 Apeak)			4 optoisolated 200kHz 24Vdc
SM1A542PN342_NO	c1490	24 Vdc	18 ÷ 48 Vac	0 ÷ 4.2 Arms (0 ÷ 6.0 Apeak)			4 optoisolated 200kHz 24Vdc
SM1A542PN342_NO	c2490	24 Vdc	18 ÷ 48 Vac	0 ÷ 4.2 Arms (0 ÷ 6.0 Apeak)			4 optoisolated 200kHz 24Vdc
SM1A542PN372_40	c0490	24 Vdc	18 ÷ 48 Vac	0 ÷ 4.2 Arms (0 ÷ 6.0 Apeak)			4 optoisolated 200kHz 24Vdc
SM1A542PN372_40	c1490	24 Vdc	18 ÷ 48 Vac	0 ÷ 4.2 Arms (0 ÷ 6.0 Apeak)			4 optoisolated 200kHz 24Vdc
SM1A542PN372_40	c2490	24 Vdc	18 ÷ 48 Vac	0 ÷ 4.2 Arms (0 ÷ 6.0 Apeak)	4 optoisolated 200kHz 24Vdc		
SM1A542PN372_NO	c0490	24 Vdc	18 ÷ 48 Vac	0 ÷ 4.2 Arms (0 ÷ 6.0 Apeak)	4 optoisolated 200kHz 24Vdc		
SM1A542PN372_NO	c1490	24 Vdc	18 ÷ 48 Vac	0 ÷ 4.2 Arms (0 ÷ 6.0 Apeak)	4 optoisolated 200kHz 24Vdc		
SM1A542PN372_NO	c2490	24 Vdc	18 ÷ 48 Vac	0 ÷ 4.2 Arms (0 ÷ 6.0 Apeak)	4 optoisolated 200kHz 24Vdc		
SM1A642PN342_40	c0490	Single 18 ÷ 48 Vac		0 ÷ 4.2 Arms (0 ÷ 6.0 Apeak)	4 optoisolated 200kHz 24Vdc		
SM1A642PN342_40	c1490	Single 18 ÷ 48 Vac		0 ÷ 4.2 Arms (0 ÷ 6.0 Apeak)	4 optoisolated 200kHz 24Vdc		
SM1A642PN342_40	c2490	Single 18 ÷ 48 Vac		0 ÷ 4.2 Arms (0 ÷ 6.0 Apeak)	4 optoisolated 200kHz 24Vdc		
SM1A642PN342_NO	c0490	Single 18 ÷ 48 Vac		0 ÷ 4.2 Arms (0 ÷ 6.0 Apeak)	4 optoisolated 200kHz 24Vdc		
SM1A642PN342_NO	c1490	Single 18 ÷ 48 Vac		0 ÷ 4.2 Arms (0 ÷ 6.0 Apeak)	4 optoisolated 200kHz 24Vdc		
SM1A642PN342_NO	c2490	Single 18 ÷ 48 Vac		0 ÷ 4.2 Arms (0 ÷ 6.0 Apeak)	4 optoisolated 200kHz 24Vdc		
SM1A642PN372_40	c0490	Single 18 ÷ 48 Vac		0 ÷ 4.2 Arms (0 ÷ 6.0 Apeak)	4 optoisolated 200kHz 24Vdc		
SM1A642PN372_40	c1490	Single 18 ÷ 48 Vac		0 ÷ 4.2 Arms (0 ÷ 6.0 Apeak)	4 optoisolated 200kHz 24Vdc		
SM1A642PN372_40	c2490	Single 18 ÷ 48 Vac		0 ÷ 4.2 Arms (0 ÷ 6.0 Apeak)	4 optoisolated 200kHz 24Vdc		
SM1A642PN372_NO	c0490	Single 18 ÷ 48 Vac		0 ÷ 4.2 Arms (0 ÷ 6.0 Apeak)	4 optoisolated 200kHz 24Vdc		
SM1A642PN372_NO	c1490	Single 18 ÷ 48 Vac		0 ÷ 4.2 Arms (0 ÷ 6.0 Apeak)	4 optoisolated 200kHz 24Vdc		
SM1A642PN372_NO	c2490	Single 18 ÷ 48 Vac		0 ÷ 4.2 Arms (0 ÷ 6.0 Apeak)	4 optoisolated 200kHz 24Vdc		

System resources					Mechanical data
Digital outputs	Analog input	Interface	Encoder	Control	
2 optoisolated 24Vdc 100mA	---	CANbus	400 ppr incremental	Mode eePLC Studio Canopen	B Dimensions: 124.0x60.0x100.5 mm Motor shaft diameter: Ø 8.0 mm Motor shaft D-cut: 0.5x20.0 mm Weight: 1450 g.
2 optoisolated 24Vdc 100mA	---	CANbus	400 ppr incremental	Mode eePLC Studio Canopen with cam management	
2 optoisolated 24Vdc 100mA	---	CANbus	---	Mode eePLC Studio Canopen	
2 optoisolated 24Vdc 100mA	---	CANbus	---	Mode eePLC Studio Canopen with cam management	
2 optoisolated 24Vdc 100mA	1 ±10Vdc or potentiometer	CANbus	400 ppr incremental	Mode eePLC Studio Canopen	
2 optoisolated 24Vdc 100mA	1 ±10Vdc or potentiometer	CANbus	400 ppr incremental	Mode eePLC Studio Canopen with cam management	
2 optoisolated 24Vdc 100mA	1 ±10Vdc or potentiometer	CANbus	---	Mode eePLC Studio Canopen	
2 optoisolated 24Vdc 100mA	1 ±10Vdc or potentiometer	CANbus	---	Mode eePLC Studio Canopen with cam management	
2 optoisolated 24Vdc 100mA	---	CANbus	400 ppr incremental	Mode eePLC Studio Canopen	
2 optoisolated 24Vdc 100mA	---	CANbus	400 ppr incremental	Mode eePLC Studio Canopen with cam management	
2 optoisolated 24Vdc 100mA	---	CANbus	---	Mode eePLC Studio Canopen	C Dimensions: 124.0x60.0x109.5 mm Motor shaft diameter: Ø 8.0 mm Motor shaft D-cut: 0.5x20.0 mm Weight: 1620 g.
2 optoisolated 24Vdc 100mA	---	CANbus	---	Mode eePLC Studio Canopen with cam management	
2 optoisolated 24Vdc 100mA	1 ±10Vdc or potentiometer	CANbus	400 ppr incremental	Mode eePLC Studio Canopen	
2 optoisolated 24Vdc 100mA	1 ±10Vdc or potentiometer	CANbus	400 ppr incremental	Mode eePLC Studio Canopen with cam management	
2 optoisolated 24Vdc 100mA	1 ±10Vdc or potentiometer	CANbus	---	Mode eePLC Studio Canopen	
2 optoisolated 24Vdc 100mA	1 ±10Vdc or potentiometer	CANbus	---	Mode eePLC Studio Canopen with cam management	
2 optoisolated 24Vdc 100mA	---	Serial RS232/485	400 ppr incremental	Mode eePLC Studio Canopen	
2 optoisolated 24Vdc 100mA	---	Serial RS232/485	400 ppr incremental	Mode eePLC Studio Modbus with cam management	
2 optoisolated 24Vdc 100mA	---	Serial RS232/485	400 ppr incremental	Mode eePLC Studio Modbus with 'Labelling Premium'	
2 optoisolated 24Vdc 100mA	---	Serial RS232/485	---	Mode eePLC Studio Canopen	
2 optoisolated 24Vdc 100mA	---	Serial RS232/485	---	Mode eePLC Studio Modbus with cam management	D Dimensions: 124.0x60.0x120.5 mm Motor shaft diameter: Ø 8.0 mm Motor shaft D-cut: 0.5x20.0 mm Weight: 2050 g.
2 optoisolated 24Vdc 100mA	---	Serial RS232/485	---	Mode eePLC Studio Modbus with 'Labelling Premium'	
2 optoisolated 24Vdc 100mA	1 ±10Vdc or potentiometer	Serial RS232/485	400 ppr incremental	Mode eePLC Studio Canopen	
2 optoisolated 24Vdc 100mA	1 ±10Vdc or potentiometer	Serial RS232/485	400 ppr incremental	Mode eePLC Studio Modbus with cam management	
2 optoisolated 24Vdc 100mA	1 ±10Vdc or potentiometer	Serial RS232/485	400 ppr incremental	Mode eePLC Studio Modbus with 'Labelling Premium'	
2 optoisolated 24Vdc 100mA	1 ±10Vdc or potentiometer	Serial RS232/485	---	Mode eePLC Studio Canopen	
2 optoisolated 24Vdc 100mA	1 ±10Vdc or potentiometer	Serial RS232/485	---	Mode eePLC Studio Modbus with cam management	
2 optoisolated 24Vdc 100mA	1 ±10Vdc or potentiometer	Serial RS232/485	---	Modalità eePLC Studio con 'Etichettatura Premium'	
2 optoisolated 24Vdc 100mA	---	Serial RS232/485	400 ppr incremental	Mode eePLC Studio Canopen	
2 optoisolated 24Vdc 100mA	---	Serial RS232/485	400 ppr incremental	Mode eePLC Studio Modbus with cam management	
2 optoisolated 24Vdc 100mA	---	Serial RS232/485	400 ppr incremental	Mode eePLC Studio Modbus with 'Labelling Premium'	E Dimensions: 124.0x60.0x141.5mm Motor shaft diameter: Ø 8.0 mm Motor shaft D-cut : 0.5x20.0 mm Weight: 2250 g.
2 optoisolated 24Vdc 100mA	---	Serial RS232/485	---	Mode eePLC Studio Canopen	
2 optoisolated 24Vdc 100mA	---	Serial RS232/485	---	Mode eePLC Studio Modbus with cam management	
2 optoisolated 24Vdc 100mA	---	Serial RS232/485	---	Modalità eePLC Studio con 'Etichettatura Premium'	
2 optoisolated 24Vdc 100mA	1 ±10Vdc or potentiometer	Serial RS232/485	400 ppr incremental	Mode eePLC Studio Canopen	
2 optoisolated 24Vdc 100mA	1 ±10Vdc or potentiometer	Serial RS232/485	400 ppr incremental	Mode eePLC Studio Modbus with cam management	
2 optoisolated 24Vdc 100mA	1 ±10Vdc or potentiometer	Serial RS232/485	400 ppr incremental	Mode eePLC Studio Modbus with 'Labelling Premium'	
2 optoisolated 24Vdc 100mA	1 ±10Vdc or potentiometer	Serial RS232/485	---	Mode eePLC Studio Canopen	
2 optoisolated 24Vdc 100mA	1 ±10Vdc or potentiometer	Serial RS232/485	---	Mode eePLC Studio Modbus with cam management	
2 optoisolated 24Vdc 100mA	1 ±10Vdc or potentiometer	Serial RS232/485	---	Mode eePLC Studio Modbus with 'Labelling Premium'	

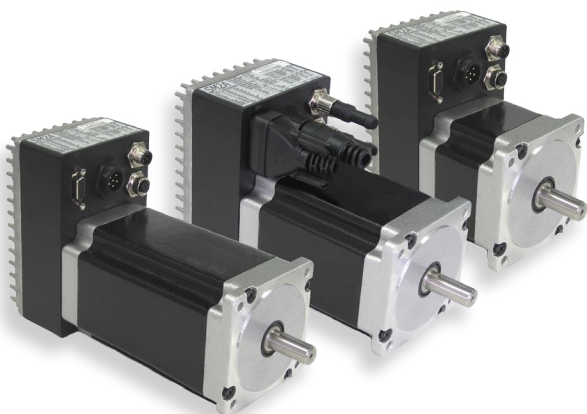

SM2A Programmable drive, 86 mm Motor and Encoder in one device

Description:

The programmable drives with integrated motor of the SM2A series with c0499 firmware are high performance devices, consisting of a Full Digital drive based on the precise pwm technology embedded in the f⁴d² firmware to control the sinusoidal current, a 50 poles high torque motor and an optional encoder to **control the torque, velocity and position of the motor** in open as well as **in closed loop** for less noise, less heating, smooth motions and energy saving. The SM2A units are programmable by the user by means of the PC Windows environment Atomic, and are available in a wide power range with 3.4" flange (86 mm) motors. Besides compactness and power, the SM2A series offers maximum versatility and reliability, and a remarkable saving of wiring and electrical switchboards. By programming the motor movements and hardware resources which are available in different versions, and having at your disposal the advanced Control Modality implementations in the real time power module, you can drive your own application fast and easy.

Main features:

- Integrated PLC
- Multiform Control modalities
- On Board Safety provisions:
 - ✓ fully tested for direct installation unit
 - ✓ built in watch dog functionality
 - ✓ fault monitoring and handling
 - ✓ on field working errors buffering
 - ✓ separated power supply for logic and power
- Main advantages of the servomotors:
 - ✓ low motor vibration
 - ✓ low mechanical noise
 - ✓ low heat production
 - ✓ closed loop of torque, velocity and position
 - ✓ protection class IP65
 - ✓ no resonance
 - ✓ high reliability
 - ✓ AC power supply
 - ✓ wide range of power

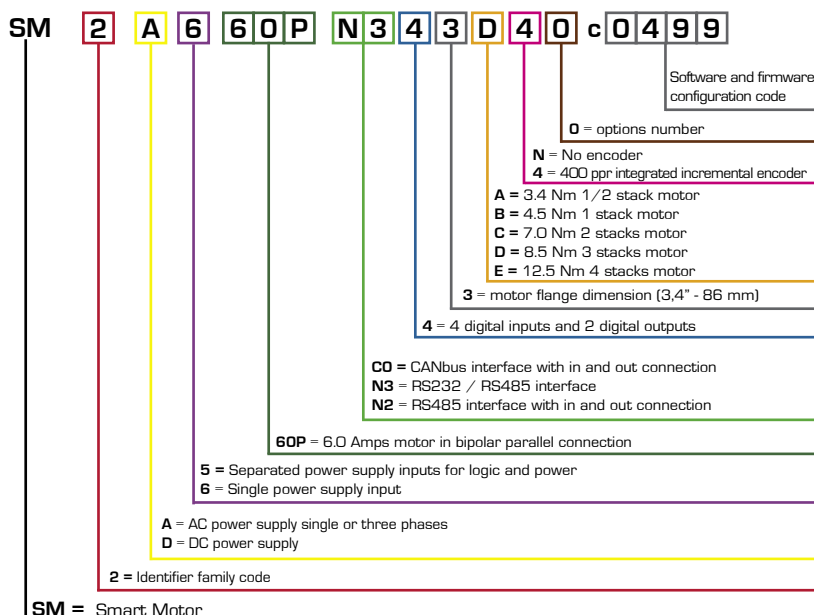

Specifications:

Torque: 3.4 Nm, 4.5 Nm, 7.0 Nm, 8.5 Nm, 12.5 Nm motors.

Power stage: 40 kHz H-bridge Bipolar chopper.

Current: 8.0 Arms (11.0 Apeak).

Optoisolated control busses: RS232 / RS422 / RS485 / CANbus.

Inputs/Outputs: 4 digital optocoupled inputs / 2 digital optocoupled outputs (100 mA) 2 analog inputs (potentiometer or ±10Vdc).

Step resolution: from 1 to 128 microsteps (open loop) / StepLess technology (closed loop)

Safety protection: Over/Under-voltage, Over Current, Over Temperature, Open Windings, Closed Windings Phase/Phase Phase/Ground.

Protection class: IP65.

Control modalities:

- Stand alone mode
- Velocity Control Modality
- Wide range of Positioning Control modalities (homing, relative, absolute, target)
- Electric Gear with programmable gear ratio to track external master reference (from fieldbus or incremental encoder) of motor Speed and Position
- High speed I/O triggered motor start & stop to event synchronizing for fast response demanding application: labeling, nick_finder, on fly cut., etc ..
- Multi Axis movements synchronization capability
- On fly change among any Motion Module Control modalities
- On fly Electric Gear Enable/Disable capability
- Motor Stall detection & Target Position tracking through encoder feedback
- Advantages of Closed Loop Control:

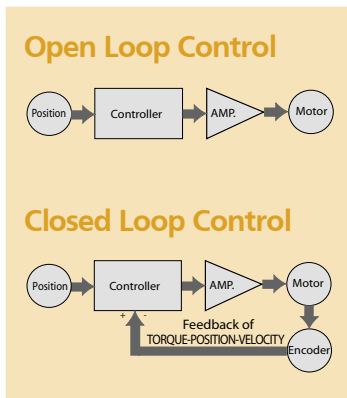

- rispetto ad una soluzione passo-passo in loop aperto:
 - reliable positioning without synchronism loss;
 - keeps the original position stable and recovers it automatically in case of positioning errors caused by external factors such as mechanical vibrations:
 - 100% use of the motor torque;
 - capacity to operate at high velocity related to the current control, which is adjusted depending on the load variations, where the normal systems in open loop use a constant current control at all velocities without considering the load variations.
- compared with a brushless servo controlled solution:
 - no need to adjust the power (automatic current regulation depending on the load changes);
 - keeping the position stable without fluctuations after completing the positioning;
 - quick positioning favoured by the independent control of the integrated DSP;
 - continuous and fast execution of short stroke movements thanks to the short positioning time.

The programming of the application cycle and all hardware resources of the drive is done by means of Atomic IDE, a PC Windows software tool, fast to use and complete with debugging tools. The tool doesn't require the knowledge of any programming language: the macro instructions are inserted by means of guided windows in which the requested parameters must be inserted.

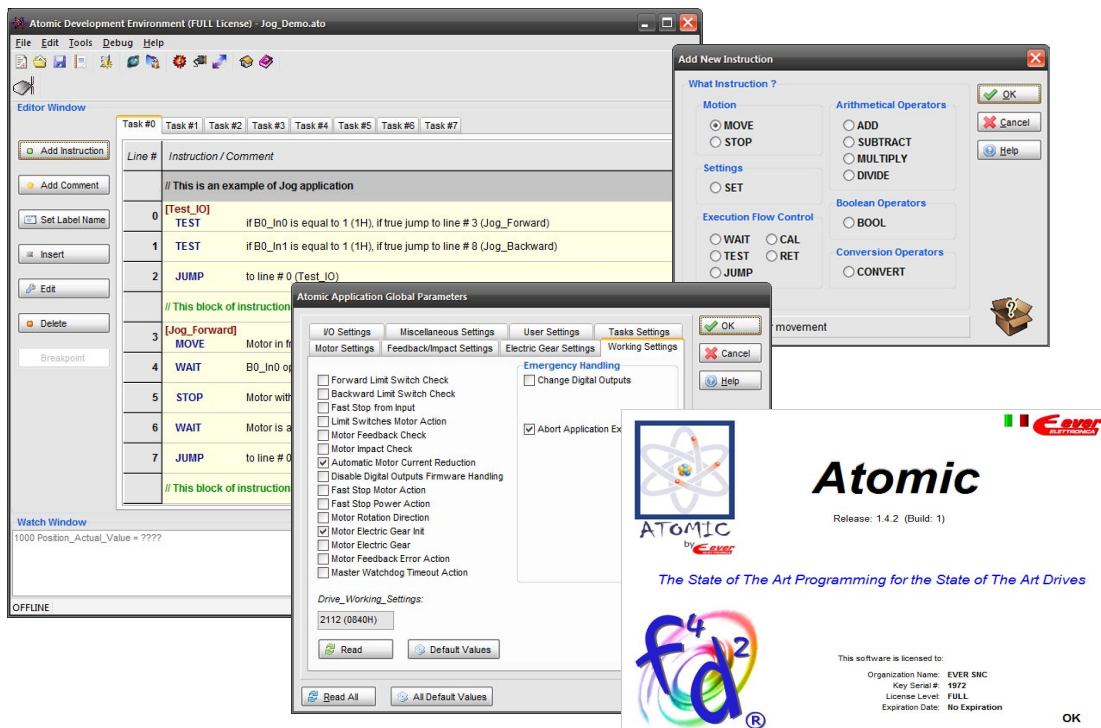

see Atomic at pag. 49

Order code		Power		Current	Motor	Digital inputs		
Versions	Configurations	Power supply Logic	Power					
SM2A560PN243_40	c0499	24 Vdc	18 ÷ 100 Vac	0 ÷ 8.0 Arms (0 ÷ 11.0 Apeak)	A Holding torque 3.40 Nm±10% Phase resistance 0.29 ohm ±10% Phase inductance 1.70 mH ±10% Detent torque 0.08 Nm Rotor inertia 1000 g.cm ²	4 optoisolated 200 kHz 24 Vdc PNP or NPN*		
SM2A560PN243_50								
SM2A560PN263_40								
SM2A560PN263_50								
SM2A560PN243_N0	c0499	24 Vdc	18 ÷ 100 Vac	0 ÷ 8.0 Arms (0 ÷ 11.0 Apeak)		B Holding torque 4.50 Nm±10% Phase resistance 0.19 ohm ±10% Phase inductance 1.70 mH ±10% Detent torque 0.13 Nm Rotor inertia 1400 g.cm ²	4 optoisolated 200 kHz 24 Vdc PNP or NPN*	
SM2A560PN263_N0								
SM2A660PN243_40	c0499	18 ÷ 100 Vac	0 ÷ 8.0 Arms (0 ÷ 11.0 Apeak)	C Holding torque 7.00 Nm±10% Phase resistance 0.25 ohm ±10% Phase inductance 2.50 mH ±10% Detent torque 0.21 Nm Rotor inertia 1900 g.cm ²			4 optoisolated 200 kHz 24 Vdc PNP or NPN*	
SM2A660PN243_50								
SM2A660PN263_40								
SM2A660PN263_50								
SM2A660PN243_N0	c0499	18 ÷ 100 Vac	0 ÷ 8.0 Arms (0 ÷ 11.0 Apeak)		D Holding torque 8.50 Nm±10% Phase resistance 0.27 ohm ±10% Phase inductance 3.00 mH ±10% Detent torque 0.25 Nm Rotor inertia 2700 g.cm ²		4 optoisolated 200 kHz 24 Vdc PNP or NPN*	
SM2A660PN263_N0								
SM2A560PN343_40	c0499	24 Vdc	18 ÷ 100 Vac			0 ÷ 8.0 Arms (0 ÷ 11.0 Apeak)	E Holding torque 12.50 Nm±10% Phase resistance 0.35 ohm ±10% Phase inductance 4.80 mH ±10% Detent torque 0.38 Nm Rotor inertia 4000 g.cm ²	4 optoisolated 200 kHz 24 Vdc PNP or NPN*
SM2A560PN343_50								
SM2A560PN363_40								
SM2A560PN363_50								
SM2A560PN343_N0	c0499	24 Vdc	18 ÷ 100 Vac	0 ÷ 8.0 Arms (0 ÷ 11.0 Apeak)		E Holding torque 12.50 Nm±10% Phase resistance 0.35 ohm ±10% Phase inductance 4.80 mH ±10% Detent torque 0.38 Nm Rotor inertia 4000 g.cm ²		4 optoisolated 200 kHz 24 Vdc PNP or NPN*
SM2A560PN363_N0								
SM2A660PN343_40	c0499	18 ÷ 100 Vac	0 ÷ 8.0 Arms (0 ÷ 11.0 Apeak)	E Holding torque 12.50 Nm±10% Phase resistance 0.35 ohm ±10% Phase inductance 4.80 mH ±10% Detent torque 0.38 Nm Rotor inertia 4000 g.cm ²	4 optoisolated 200 kHz 24 Vdc PNP or NPN*			
SM2A660PN343_50								
SM2A660PN363_40								
SM2A660PN363_50								
SM2A660PN343_N0	c0499	18 ÷ 100 Vac	0 ÷ 8.0 Arms (0 ÷ 11.0 Apeak)		E Holding torque 12.50 Nm±10% Phase resistance 0.35 ohm ±10% Phase inductance 4.80 mH ±10% Detent torque 0.38 Nm Rotor inertia 4000 g.cm ²		4 optoisolated 200 kHz 24 Vdc PNP or NPN*	
SM2A660PN363_N0								

* = NPN solo per i dispositivi senza ingressi analogici

System resources					Mechanical data
Digital outputs	Analog inputs	Interface	Encoder	Control	
2 optoisolate 24 Vcc 500 mA	---	Serial RS485	400 ppr incremental	Mode Atomic	A Dimensions: 135.0x86.0x150.5 mm Motor shaft diameter: Ø 9.525 mm Motor shaft key 3.0x3.0x22.0 mm Weight: 2600 g.
			1000 ppr incremental		
	2 ±10 Vdc or potentiometer		400 ppr incremental		
	1000 ppr incremental				
2 optoisolated 24 Vdc 500 mA	---	Serial RS485	---	Mode Atomic	
			2 ±10 Vdc or potentiometer		
2 optoisolated 24 Vdc 500 mA	---	Serial RS485	400 ppr incremental	Mode Atomic	
			1000 ppr incremental		
	2 ±10 Vdc or potentiometer		400 ppr incremental		
	1000 ppr incremental				
2 optoisolated 24 Vdc 500 mA	---	Serial RS485	---	Mode Atomic	
			2 ±10 Vdc or potentiometer		
2 optoisolated 24 Vdc 500 mA	---	Serial RS232/485	400 ppr incremental	Mode Atomic	
			1000 ppr incremental		
	2 ±10 Vdc or potentiometer		400 ppr incremental		
	1000 ppr incremental				
2 optoisolated 24 Vdc 500 mA	---	Serial RS232/485	---	Mode Atomic	
			2 ±10 Vdc or potentiometer		
2 optoisolated 24 Vdc 500 mA	---	Serial RS232/485	400 ppr incremental	Mode Atomic	
			1000 ppr incremental		
	2 ±10 Vdc or potentiometer		400 ppr incremental		
	1000 ppr incremental				
2 optoisolated 24 Vdc 500 mA	---	Serial RS232/485	---	Mode Atomic	
			2 ±10 Vdc or potentiometer		

A
Dimensions: 135.0x86.0x150.5 mm
Motor shaft diameter: Ø 9.525 mm
Motor shaft key 3.0x3.0x22.0 mm
Weight: 2600 g.

B
Dimensions: 135.0x86.0x165.5 mm
Motor shaft diameter: Ø 12.70 mm
Motor shaft key 3.175x3.175x22.23 mm
Weight: 3200 g.

C
Dimensions: 135.0x86.0x179.5 mm
Motor shaft diameter: Ø 12.70 mm
Motor shaft key 3.175x3.175x22.23 mm
Weight: 4100 g.

D
Dimensions: 135.0x86.0x203.5 mm
Motor shaft diameter: Ø 12.70 mm
Motor shaft key 3.175x3.175x22.23 mm
Weight: 4700 g.

E
Dimensions: 135.0x86.0x242.0 mm
Motor shaft diameter: Ø 15.87 mm
Motor shaft key 4.763x4.763x22.23 mm
Weight: 6200 g.

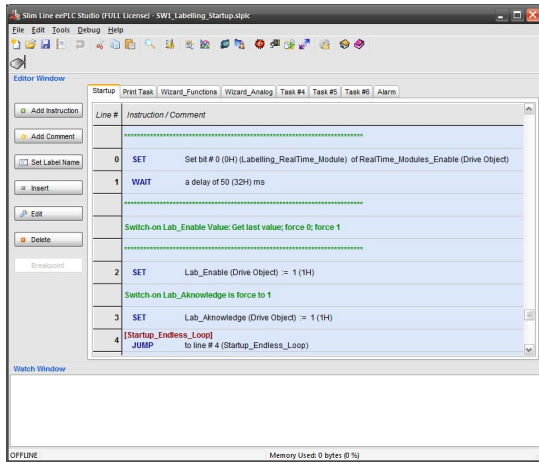

Description:

All SW systems with c1490 or c0490 firmware are easy to program by the user by means of eePLC Studio IDE. This PC Windows development environment integrates the functionalities of PLC, motion module, process module and drive in one single device. The programming of the machine cycle or the customized process phases of the device can be done very quickly, just as all debugging phases of the solution.

traditional solution

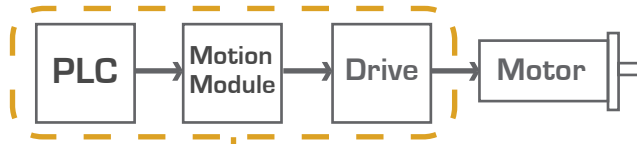

eePLC solution



eePLC Studio Programming environment for SW and SM1A drives

Main features:

- Software programming environment for the SW1 SlimLine drives with configurations c0490 and c1490.
- Directly deriving from Atomic IDE.
- Intuitive and easy to use as you don't need to learn any programming language.
- Designed to create multitasking applications.
- Complete with *Advanced Motion Module* for the PLC functionalities.
- Integrated Real-time Labelling Wizard Module for the complete advanced management of a labelling head.
- Integrated module for electronic CAMs management (configurations c1490).
- Complete with software tools to quickly debug the developed application.
- Drives firmware update functionality.
- Support and training by Ever Elettronica staff.

Wizard:

Labelling Real-time Module and the Wizard Labelling Setup

The *Labelling Real-time Module* implements the typical functions of a labelling head. In particular it handles with absolute precision the typical signals of a labelling head:

- product presence detection (start);
- label gap detection (stop);
- synchronization of the label velocity with the product velocity and application of the label always on the same point also during the acceleration and deceleration phases of the product transport belt. (encoder).

By enabling the Labelling_Realtime module, which can be activated in the SW1 drives with c0490 or c1490 configuration, it's possible to create automatically, by means of a simple wizard, the complete control cycle of a labelling head, besides it's also possible by means of the eePLC Studio environment, to add other functionalities necessary for the application. The performances of this solution are: maximum labelling speed up to 80 m/min: label positioning error less then 1 mm: perfect synchronism between product speed and label speed; external encoder for the velocity reference and product position; buffering of up to 16 products; programmable filter for the product presence signal; programmable filter for the label gap signal.

Electronic CAM management module

The *Advanced Motion Module* in the drives with c1490 configuration is integrated in the electronic CAM module. This module is retrievable by means of the eePLC Studio IDE environment and serves to completely calculate and manage the electronic CAMs. Then, by means of a simple interface window, it's possible to program easy and fast by means of eePLC the desired CAM motion and all necessary related parameters.



ATOMIC Programming environment for SD and SM2A drives

Main features:

- Software environment to program the SD Enhanced and SD drives and the SM2A servomotors.
- Intuitive and easy to use as no new language syntax study is required.
- Designed to create multitasking applications with up to 8 tasks per user.
- Complete with *Advanced Motion Module* for the PLC functionalities.
- Motion programming in closed loop of torque, velocity and position.
- Created to exploit all power of the DSPC and all hardware resources integrated in the drives.
- Complete with software tools to simplify the diagnostic of the created application.
- Functionality to update the drives' firmware.
- Support and training by the Ever Electronica staff.

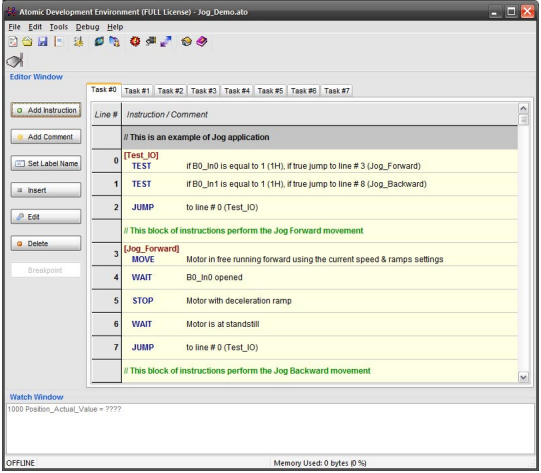

Description:

Atomic is a micro-language to program the SD drives and the SM2A servomotors developed with the aim to offer the user the freedom to create its own application without needing to switch to more expensive and complex drives and without needing to learn new programming languages. Atomic runs on PC Windows operating systems and puts at the user's disposal powerful macro instructions that can be called and edited through guided windows and that have been designed to offer the biggest advantage in terms of compilation versatility and speed.

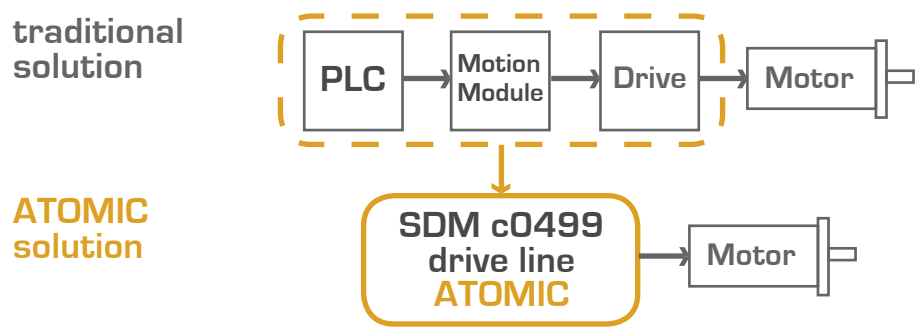

The Atomic manager enables the user to access all features, objects, inputs/outputs and drive resources and to manage and synchronize the motion module and resources of other drives with every process event, and gives direct access to all advanced features of the power motion module.

M5A

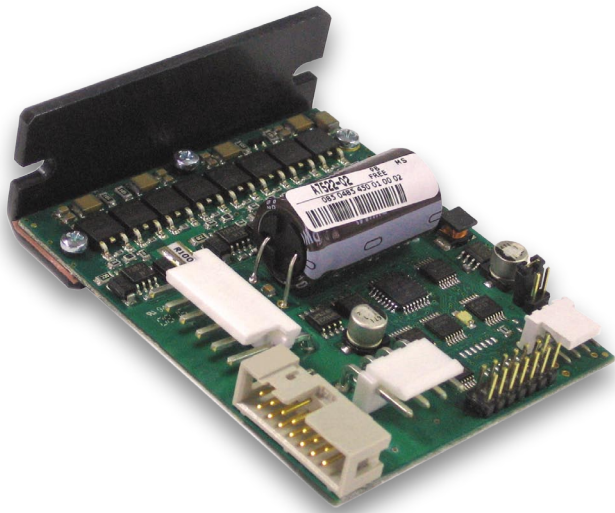

M5A Full Digital software controlled drivers

Main features:

- Power supply: 24 ÷ 60 Vdc for power stage;
5 Vdc for Logic stage;
- Phase current: 0 ÷ 6.0 A peak;
- Step angle: from full step to 1/128 step;
- Protections: over- and under-voltage, over-current and over-temperature;
- Digital inputs: # 3 5 Vdc, (In0, In1, Reset);
- Analog input: # 1 3Vdc (Sens_Coll);
- Analog output: # 1 5Vdc (Sens_Anod);
- Interfaces: serial RS485 or bus I2C;
- Functions: modbus communication, ck/dir operations or internal clock motor movement control;
- Jumpers: for user's functions;
- Software development tool (SL-monitor Modbus)
- Firmware updating function;
- Status monitoring LED
- Retentive memory
- Dimensions: 85.0 x 70.0 x 26.0 mm;
- Weight: 350g approx;

Description:

The M5A is a Full Digital software controlled drive, fully customizable and designed for the complete control of a stepper motor against a **really advantageous cost** offering optimal performances, high resolutions, low temperatures and the availability of a fieldbus connection.

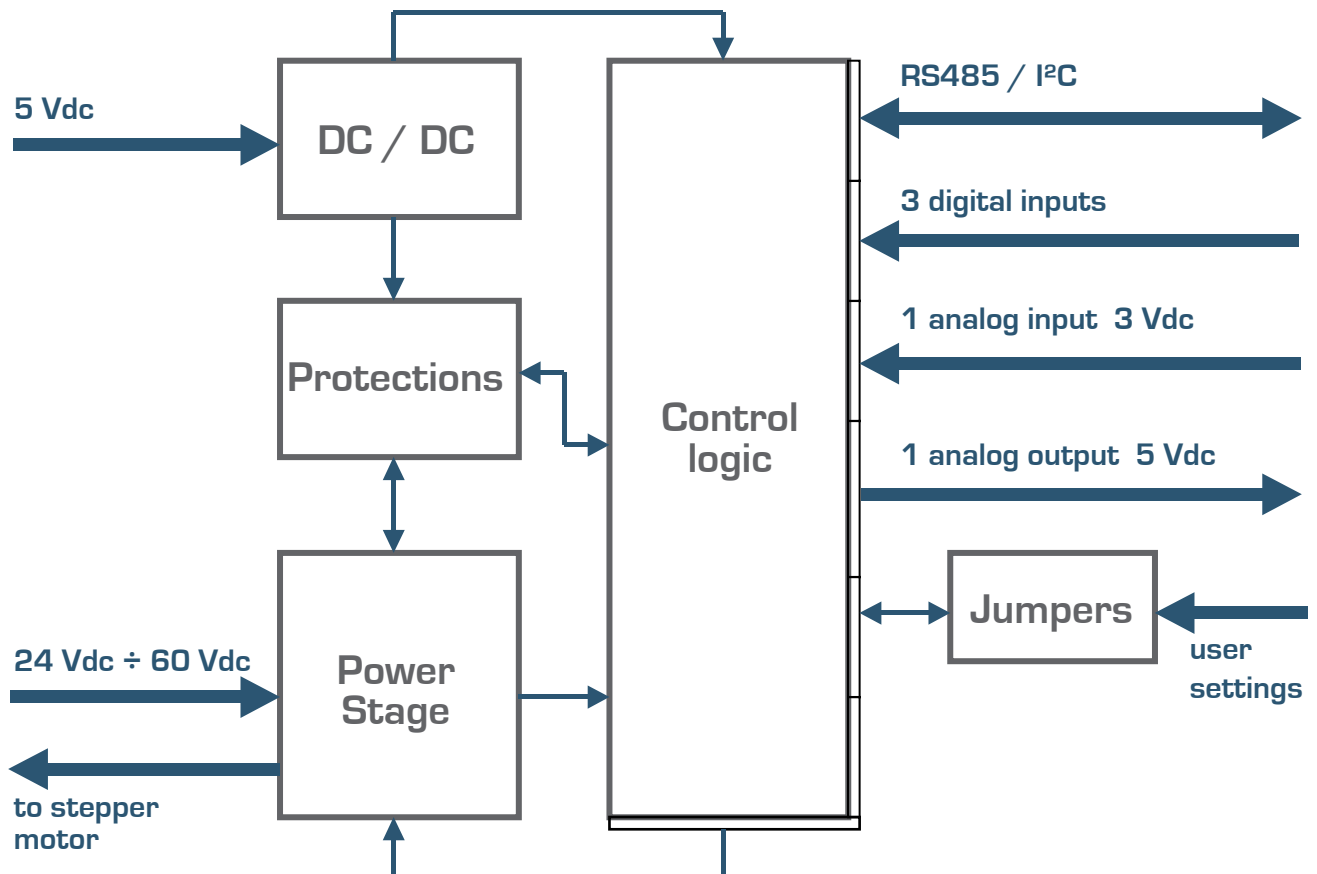

DCM Azionamento Full Digital

Main features:

- Power supply: 12 ÷ 24 Vdc;
- Phase current: 0 ÷ 500 mA (rms);
- Digital inputs: 3 (5 Vdc PNP Ttl electrically not-isolated);
- Step angle: from full step to 1/128 step;
- Digital output: 1 Fault (5 Vdc NPN open collector electrically not-isolated)
- Analog input: 1 (0 ÷ 10 Vdc);
- Status monitoring LED;
- Protections: over- and under-voltage, over-current and over temperature;
- Serial RS232 interface electrically isolated;
- Serial protocol: Modbus;
- Functions: modbus communication, ck/dir operations or internal clock motor movement control;
- Firmware updating function;
- Software development tool (SL modbus monitor);
- Smoothing function;
- Dimensions: 67.0 x 63.0 x 14.0 mm;

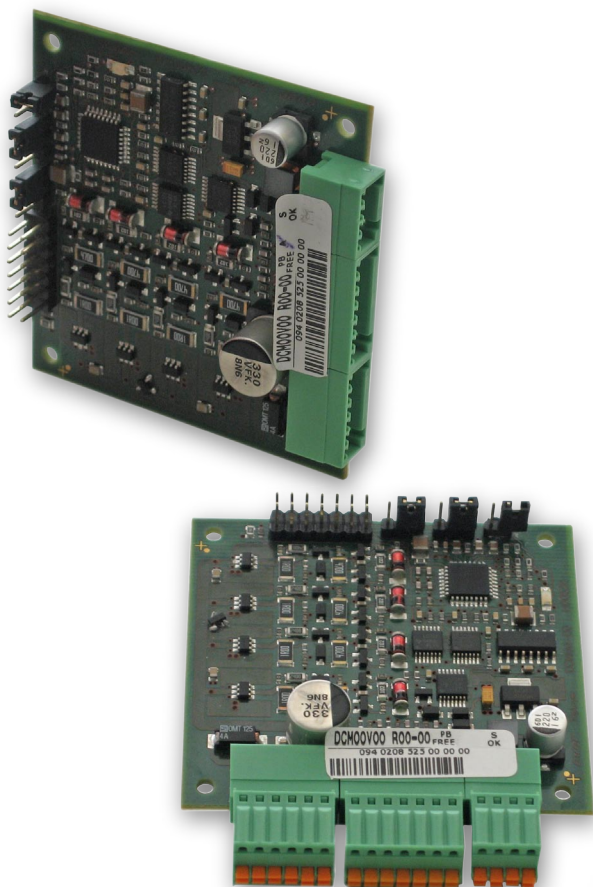

Description:

The DCM board is a complete Full Digital software controlled drive that is fully customizable. It's used to execute **micro-step movements at an extremely high resolution**: up to 1/128 step. It's also possible to set a smoothing value to optimize the motor performances and to reach:

- a better torque and velocity to the shaft;
- less heating of the drive and motor;
- vibrations reduction;
- resonances elimination;
- less mechanical noise.

It's been designed to manage the power stage configured as "double H-bridge" bipolar chopper at an ultrasonic switching frequency of 33 KHz.





Programmable Human Machine Interfaces

Main features:

- Multiple operation and connection possibilities
- Advanced security operations:
 - √ integrated watch dog functionality
 - √ detection of power supply failures
- Common main features terminals
 - √ easy to connect
 - √ easy to program
 - √ conform CE and EMI standards
 - √ fan-less cooling system
 - √ high reliability
 - √ IP65 front panel protections
 - √ compact size

Description:

The HMI terminals of the VT series include models with monochrome display or with 16 M colours TFT BackLight and operator terminals with touch screen function up to 7.0". The communication with these devices takes place through a serial Modbus RS232/422/485. All units are programmable and can be supplied complete with appropriate programming to interface with the turn-key applications of our drives and motion controllers.

Programming:

The programming of the HMI unit is done by means of specific PC software interfaces used for downloading and debugging the standard and / or customized program. The programming environments are easy to use and don't require a through programming knowledge.

HMI programmed with c0490 are for drives with eePLC or Atomic application and HMI with c0450 are for drives with Labelling GoldXP. Other ready to use turn-key solutions are available for the Ever Elettronica applications.

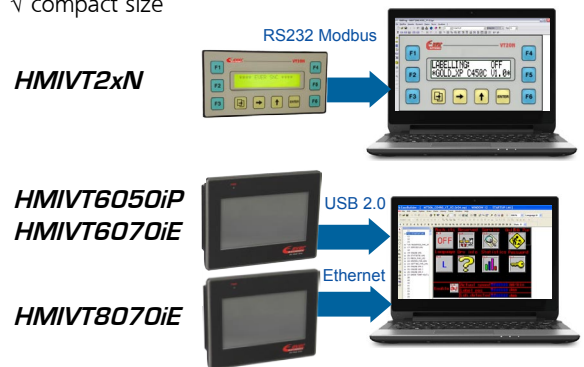

Order code		Power		System resources										
Model	Conf.	Voltage	Consumption	Keys	Backlight LCD	Front panel	CPU	Flash	Eeprom recipes	Memories DRAM DDR2				
HMIVT20N	c0450 c0490	24Vdc ±20%	150mA @ 24Vdc	6 function keys 4 command keys	20 chr x 2 monochrome lines	Front membrane IP65	N/A	64 KB	3 KB	-				
HMTVT24N	c0450 c0490				20 chr x 4 monochrome lines									
HMIVT6050iP	c0450 c0490	24Vdc ±20%	250mA @ 24Vdc	Analog resistive touch screen: - 4 wires - resolution continue - 80 % light transmission - minimal 1 million activations durability	4,3" TFT lcd led backlight 480x272 px 16 M colours 500:1 contrast 500 cd/m ² lightness 30,000 hours MBTF backlight	Front membrane NEMA4 IP65 Surface hardness 4H	32 bit RISC 400 Mhz	128 MB	48 MB	64 MB				
HMIVT6070iE	c0450 c0490				7,0" TFT lcd led backlight 800x480 px 16 M colours 500:1 contrast 350 cd/m ² lightness 30,000 hours MBTF backlight						32 bit RISC 600 Mhz	128 MB	50 MB	128 MB
HMIVT8070iE	c0450 c0490				7,0" TFT lcd led backlight 800x480 px 16 M colours 500:1 contrast 350 cd/m ² lightness 30,000 hours MBTF backlight									

Control modalities:

SINGLE AXLE APPLICATIONS

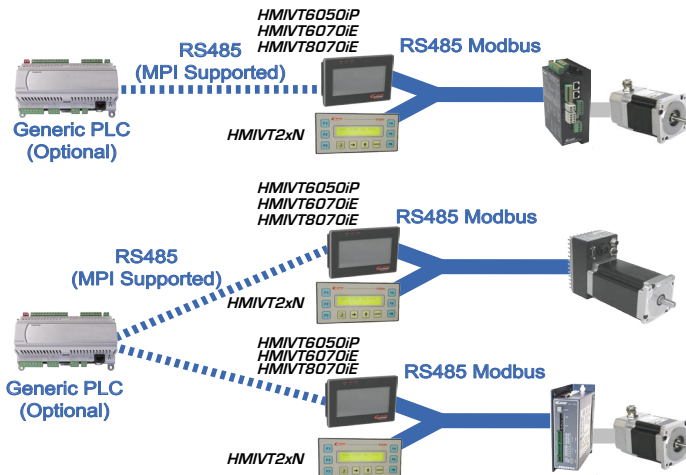

MULTI AXLE APPLICATIONS

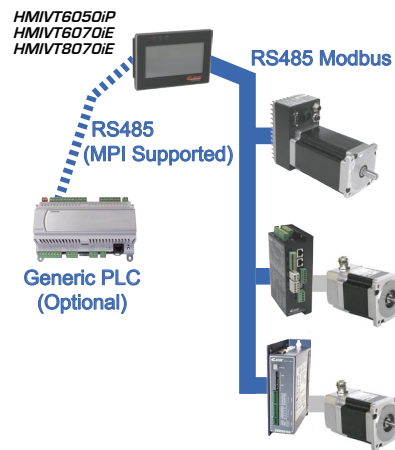

CUSTOMIZED APPLICATIONS

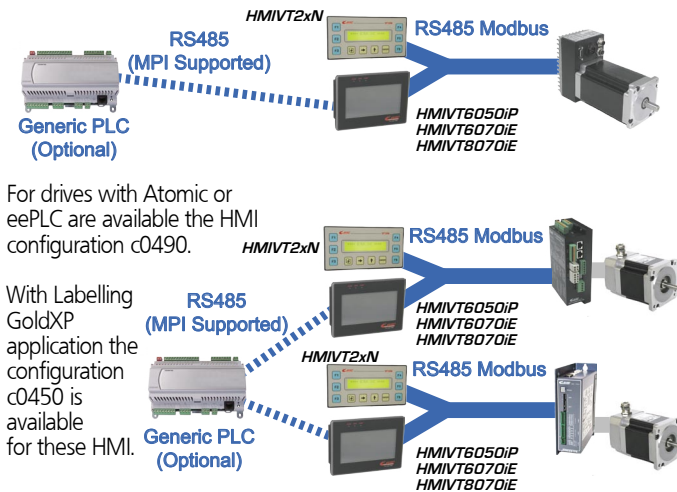

MULTI AXLE APPLICATION WITH GATEWAY AND MOTION CONTROLLER

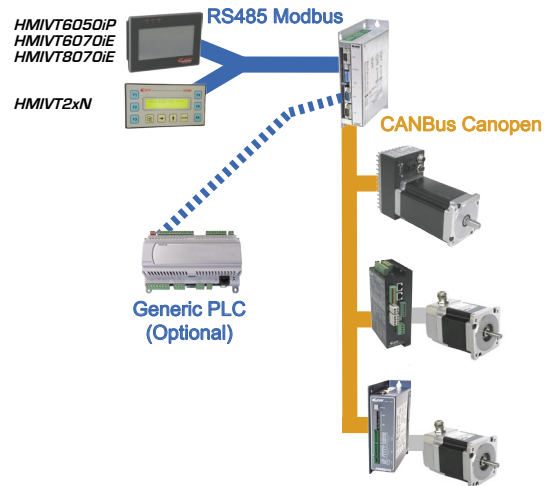

Interfaces				Mechanical data				
Serial modbus	USB 2.0	Digital I/O	Ethernet	Dimensions	Assembly measures	Connectors	Environmental	Weight
1 RS232/422/485 1 TTL	None	None	None			Power supply: cable clamps. Serial communications: - 9 pins sub-D male for TTL - 15 pins sub-D female for RS232, RS485 and RS422 connections.	Temperature: 0° ~ +50° C Humidity: 10% ~ 90% @40°C	280 g.
1 RS232/422/485 1 TTL	None	4 programmables I/O	None			Power supply and I/O: cable clamps Serial communications: - 9 pins sub-D male for TTL - 15 pins sub-D female for RS232, RS485 and RS422 connections.	Temperature: 0° ~ +50° C Humidity: 10% ~ 90% @40°C	350 g.
1RS232/485 (com1) (RS485 2 or 4 wires MPI suport)	1 (12 Mbps)	None	None			Power supply: cable clamps. Serial communications: - 9 pins sub-D female for RS232, RS485 and RS422 connections. USB: - mini USB client port A type femal.	Temperature: 0° ~ +50° C Humidity: 10% ~ 90% @40°C Shock: 10 ~ 25Hz (X,Y,Z-2G 30 m)	250 g.
1RS232/485 (com1) (RS485 2 or 4 wires MPI suport)	1 (12 Mbps)	None	None			Power supply: cable clamps. Serial communications: - 9 pins sub-D female for RS232, RS485 and RS422 connections. USB: - mini USB client port A type femal.	Temperature: 0° ~ +50° C Humidity: 10% ~ 90% @40°C Shock: 10 ~ 25Hz (X,Y,Z-2G 30 m)	600 g.
1RS232/485 (com1) (RS485 2 or 4 wires MPI suport)	--	None	FastEthernet 10/100 Base-T			Power supply: cable clamps. Serial communications: - 9 pins sub-D female for RS232, RS485 and RS422 connections. Ethernet: - RJ45	Temperature: 0° ~ +50° C Humidity: 10% ~ 90% @40°C Shock: 10 ~ 25Hz (X,Y,Z-2G 30 m)	600 g.

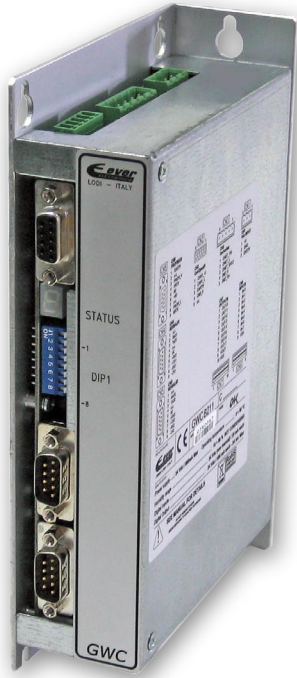

GWC Motion controller, Gateway and PLC

Main features:

- Multiple functioning modes
- Equipped with Advanced Security features:
 - √ tested for direct unit installation
 - √ built-in watchdog function
 - √ malfunctions monitoring and handling
- Main advantages of the Gateway Controller:
 - √ easy to program
 - √ local control of connected devices
 - √ real-time axes management
 - √ data interchange between the fieldbusses
 - √ high reliability and versatility
 - √ management of other manufacturer device

Description:

The GWC unit has been developed to ensure the three functions of programmable logic controller (PLC), motion controller and communication converter (gateway). The functionalities of programmable logic controller and motion controller enable the user to control a process through fieldbus, serial interface and inputs/outputs, according to the program defined by the user.

The communication converter functionality allows the data interchange between different fieldbusses: CANBus (Canopen), DeviceNet, Profibus and MODBus. The automation of a wide range of industrial applications can be simplified easily thanks to the coexistence of three functionalities in one device with a considerable economic benefit.

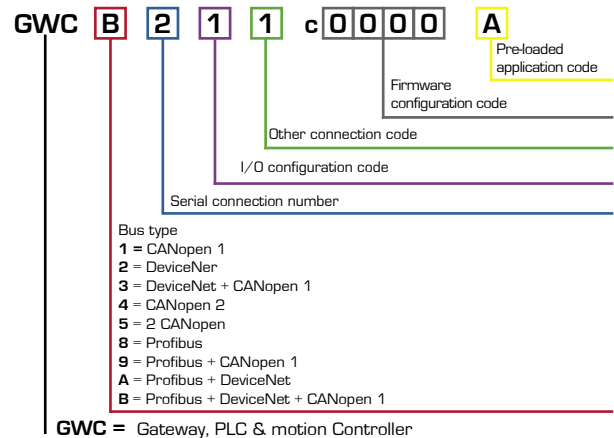

Specifications:

CPU processor: CISC 16 bit 40 MHz.

PLC e motion controller programming: TR.I.PO.S.GW compatible with Windows OS.

Memory user program: 1 Mb flash and 512 Kb ram at high speed.

Interfaces: **CANBus interface:** 1 electrically isolated, 1 Mbit/s, ISO11898 - Canopen (CAN1).

DeviceNet interface: 1 electrically isolated, or Canopen (CAN2).

Profibus-DP interface: 1 electrically isolated.

Serial interface: 2 electrically isolated RS232 / RS485, full o half-duplex.

Inputs: 8 electrically isolated 5 ÷ 24 Vdc - 200 kHz.

Outputs: 8 electrically isolated, 24 Vdc - 0.5 A - 1 kHz.

Dip switches: 8 for user configuration.

Display: 7 segment leds display indicating the operational status of the unit.

Connectors: **Power supply:** Combicon Phoenix.

CANopen: 5 poles Mini-Combicon-Style.

Profibus-DP: 9 female poles Dsub.

DeviceNet: 5 poles Mini-Combicon-Style.

Working temperature: 0° ÷ 50° C.

Umidity: 0% ÷ 90%.

Protection degree: IP20.

Order code		Power		System resources
Versions	Configurations	Power supply		Fieldbus
		Voltage	Current	
GWCB211	c1000	24 Vdc	800 mA max	1 CANbus Canopen 1 Devicenet o CANbus 1 Profibus-DP
GWCB211	c2000	24 Vdc	800 mA max	2 CANbus Canopen

Control modalities:

Thanks to the T.R.I.P.O.S.GW programming environment it's possible to personalize the machine cycle and to manage all drives and local resources, reducing and simplifying the work load of the master PLC if present.

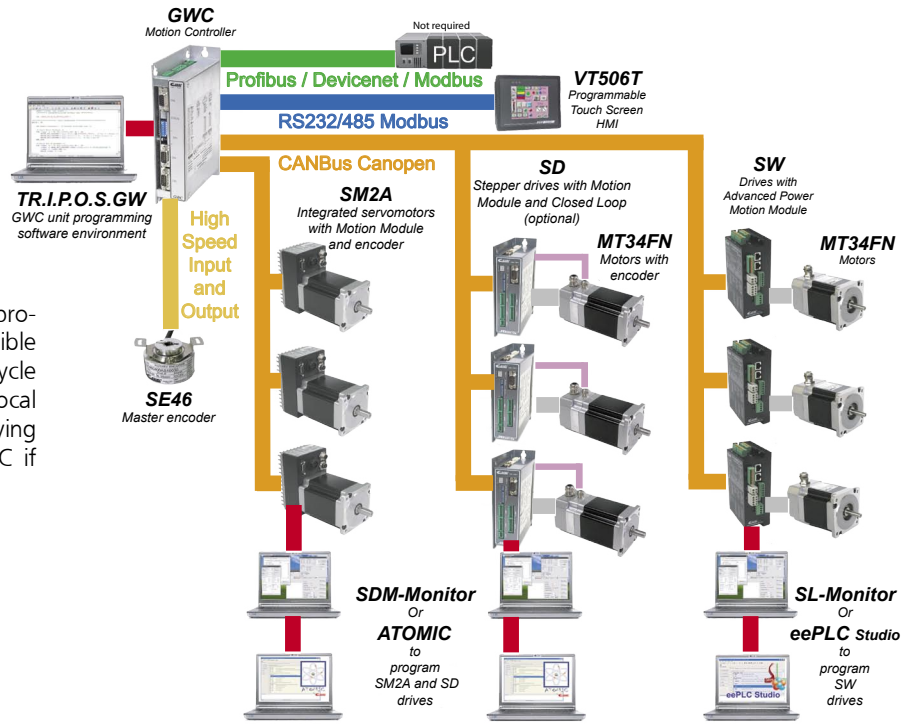

GWC Configuration	TR.I.P.O.S.GW application pre-loaded	Description	Kit software code	Kit software description	Note
c1000	None	No application pre-loaded. The unit is ready to be programmed through TR.I.P.O.S.GW	GWC_TRP232-00	CD TR.I.P.O.S.GW DEMO + RS232 cable	—
c1000	A	Horizontal Flow Pack	GWC_TRP232-00	CD TR.I.P.O.S.GW DEMO + RS232 cable	Executable with SDM or SM2A systems configured as c0300
c1000	B	Vertical Flow Pack	GWC_TRP232-00	CD TR.I.P.O.S.GW DEMO + RS232 cable	Executable with SDM or SM2A systems configured as c0300
c1000	C	Turntable Positioning	GWC_TRP232-00	CD TR.I.P.O.S.GW DEMO + RS232 cable	Executable with SDM or SM2A systems configured as c0327
c1000	D	Multi Cams Management	GWC_TRP232-00	CD TR.I.P.O.S.GW DEMO + RS232 cable	Executable with SDM or SM2A systems configured as c0326
c2000	E	Thread Winding Machine	GWC_TRP232-00	CD TR.I.P.O.S.GW DEMO + RS232 cable	Executable with SDM or SM2A systems configured as c0370
c1000	F	Multi Axles Management	GWC_TRP232-00	CD TR.I.P.O.S.GW DEMO + RS232 cable	Executable with SDM or SM2A systems configured as c0300
c1000	G	Flexographic Machine	GWC_TRP232-00	CD TR.I.P.O.S.GW DEMO + RS232 cable	Executable with SDM or SM2A systems configured as c0300

System resources			Mechanical data	
Serial interfaces	Digital inputs	Digital outputs	Dimensions	Weight
2 Serial RS232/485	8 optoisolated 200 kHz 24 Vdc PNP	8 optoisolated 24 Vdc 500 mA	194.0 x 120.0 x 45.0 mm	480 gr.
2 Serial RS232/485	8 optoisolated 200 kHz 24 Vdc PNP	8 optoisolated 24 Vdc 500 mA	194.0 x 120.0 x 45.0 mm	480 gr

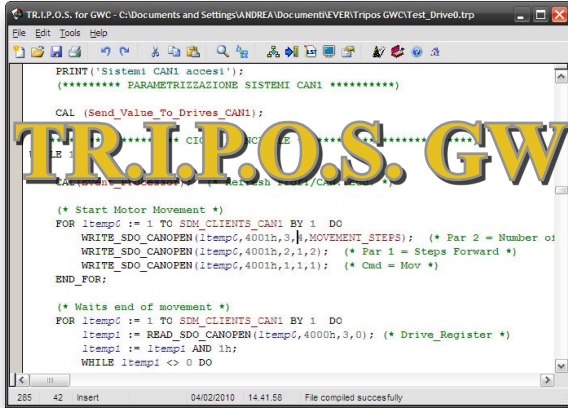

TR.I.P.O.S.GW IDE for GWC motion controllers

Main features:

- Software environment for Windows systems to program the Motion Controller/Gateway/PLC of the GWC series.
- High-level language complying with the CEI EN61131-3 standards for structured language following the (ST) and (IL) standards.
- Multitasking environment and management of tasks of different priorities.
- Ready-to-use applications available.
- **Support and training by the Ever Elettronica staff.**

Description:

The TR.I.P.O.S.GW programming environment is equipped with libraries and TR.I.P.O.S.GW ready-to-use objects for motion control. Such as:

- free running;
- micro-step movement at a precise position;
- stop at trigger;
- electronic CAM;
- Multi-axes synchronization and ability to customize motion profiles (speed, acceleration, position stroke).
- The integrated development environment offers the following advanced functionalities:
- high-level debugging;
- compatibility with the serial (Modbus RTU) and CANbus (CANopen) interfaces;
- 32 bits arithmetic and mobile comma;
- trigonometric functions;
- interrupts/tasks management;
- 128 KB RAM space for user data, 256 KB of Flash space for application programs and 8 KB of RAM buffer;
- on-line help.

To debug the application there are available different software tools among which:

The TR.I.P.O.S.GW terminal window: by means of this window is opened a direct communication window with the GWC unit and the related administrative network through which commands are inserted at real-time in order to verify or modify the drive objects or variables of the devices connected to the network. The control window (objects, variables, inputs/outputs, cycle times of the tasks, etc.).



```

TR.I.P.O.S. for GWC - C:\Documents and Settings\ANDREA\Documenti\EVER\Tripos\GWC\Test_Drived0.trp
File Edit Tools Help
PRINT ('Sistemi CAN1 accesi');
(***** PARAMETRIZZAZIONE SISTEMI CAN1 *****)

CAL (Send_Value_To_Drives_CAN1);

(***** CICLO PRINCIPALE *****)
WHILE 1 DO

  CAL(Event_Processor); (* Refresh Profi/CAN..ecc. *)

  (* Start Motor Movement *)
  FOR ltempC := 1 TO SDM_CLIENTS_CAN1 BY 1 DO
    WRITE_SDO_CANOPEN(ltempC,4001h,3,1,MOVEMENT_STEPS); (* Par 2 = Number of
    WRITE_SDO_CANOPEN(ltempC,4001h,2,1,2); (* Par 1 = Steps Forward *)
    WRITE_SDO_CANOPEN(ltempC,4001h,1,1,1); (* Cmd = Mov *)
  END_FOR;

  (* Waits end of movement *)
  FOR ltempC := 1 TO SDM_CLIENTS_CAN1 BY 1 DO
    ltempI := READ_SDO_CANOPEN(ltempC,4000h,3,0); (* Drive_Register *)
    ltempI := ltempI AND 1h;
  WHILE ltempI <> 0 DO

```

Code Wizard

Memory Areas Microinstructions

Debug Trigonometrics CANopen Profibus DeviceNET Modbus M

Arithmetics/Logics Comparisons Settings Conversions Subroutines

Syntax	Description
<Dest> := ABS (<Src>)	Return the absolute value
<Dest> := <Src1> + <Src2>	Addition of two arguments
<Dest> := <Src1> AND <Src2>	Bitwise AND of two arguments
<Dest> := <Src1> COM <Src2>	Bitwise complement of two argument
COPYBIT (<Src>, <Bit#>, <Dest>, <B#>)	Copy a source bit to a destination bit
<Dest> := <Src1> / <Src2>	Division of two arguments
<Dest> := GETBIT (<Src>, <B#>)	Return the value of the source bit #
<Dest> := LININT_VALUE (<VX>, <VY>, <L>)	Linear interpolation

Insert OK

GWC Board Configuration

GWC Internal Resources

TRIPOS User Vars in NVRAM Tripos Application Priority: Low High

Profibus DP Slave Interface (CN8)

Enable Input Area Size: 10 Bytes Task Priority: High

Create GSD Output Area Size: 10 Bytes Enable Service Channel

CANopen Master Interface (CN2/CN3)

Enable Baud Rate: 1000K bps Max 32 Slaves (CN2 Only)

More Options PDO Ch 0 (CN2) Max 64 Slaves (CN2+CN3)

DeviceNET Slave Interface (CN3)

Enable Baud Rate: 500K bps Task Priority: Medium

Create EDS I/O Area Size: 8+8 Bytes Enable Service Channel

Modbus RTU Slave Interface 0 (CN4)

Enable Baud Rate: 57600 Format: 8N1

Modbus RTU Master/Slave Interface 1 (CN5)

Enable Baud Rate: 57600 Format: 8N1

Master

Load from Disk Save to Disk Get from GWC Send to GWC

Tasks Monitor

Task Name	Status	Pri	Min Time (ms)	Max Time (ms)	Med Time (ms)	Cur Time (ms)
Task #0	Unknown	0	0.0	0.0	0.0	0.0
Task #1	Unknown	0	0.0	0.0	0.0	0.0
Task #2	Unknown	0	0.0	0.0	0.0	0.0
Task #3	Unknown	0	0.0	0.0	0.0	0.0
Task #4	Unknown	0	0.0	0.0	0.0	0.0
Task #5	Unknown	0	0.0	0.0	0.0	0.0
Task #6	Unknown	0	0.0	0.0	0.0	0.0
Task #7	Unknown	0	0.0	0.0	0.0	0.0
Task #8	Unknown	0	0.0	0.0	0.0	0.0
Task #9	Unknown	0	0.0	0.0	0.0	0.0
Task #10	Unknown	0	0.0	0.0	0.0	0.0
Task #11	Unknown	0	0.0	0.0	0.0	0.0
Task #12	Unknown	0	0.0	0.0	0.0	0.0

Refresh Save Data Clear Data

I/O Watch Window (OFFLINE)

B0 Digital Inputs B1 Digital Inputs Digital Outputs

Enable Bank 0 Digital Input Simulation

#	Status	R Edge	F Edge	Simulated	Sim. Status	Symbolic Name
0	<input type="checkbox"/>	<input type="checkbox"/>	<input type="checkbox"/>	<input type="checkbox"/>		
1	<input type="checkbox"/>	<input type="checkbox"/>	<input type="checkbox"/>	<input type="checkbox"/>		
2	<input type="checkbox"/>	<input type="checkbox"/>	<input type="checkbox"/>	<input type="checkbox"/>		
3	<input type="checkbox"/>	<input type="checkbox"/>	<input type="checkbox"/>	<input type="checkbox"/>		DL_ACQ
4	<input type="checkbox"/>	<input type="checkbox"/>	<input type="checkbox"/>	<input type="checkbox"/>		DL_STORE
5	<input type="checkbox"/>	<input type="checkbox"/>	<input type="checkbox"/>	<input type="checkbox"/>		DL_JOGAV
6	<input type="checkbox"/>	<input type="checkbox"/>	<input type="checkbox"/>	<input type="checkbox"/>		DL_JOGIN
7	<input type="checkbox"/>	<input type="checkbox"/>	<input type="checkbox"/>	<input type="checkbox"/>		DL_ORIENT
8	<input type="checkbox"/>	<input type="checkbox"/>	<input type="checkbox"/>	<input type="checkbox"/>		
9	<input type="checkbox"/>	<input type="checkbox"/>	<input type="checkbox"/>	<input type="checkbox"/>		
10	<input type="checkbox"/>	<input type="checkbox"/>	<input type="checkbox"/>	<input type="checkbox"/>		
11	<input type="checkbox"/>	<input type="checkbox"/>	<input type="checkbox"/>	<input type="checkbox"/>		
12	<input type="checkbox"/>	<input type="checkbox"/>	<input type="checkbox"/>	<input type="checkbox"/>		
13	<input type="checkbox"/>	<input type="checkbox"/>	<input type="checkbox"/>	<input type="checkbox"/>		
14	<input type="checkbox"/>	<input type="checkbox"/>	<input type="checkbox"/>	<input type="checkbox"/>		
15	<input type="checkbox"/>	<input type="checkbox"/>	<input type="checkbox"/>	<input type="checkbox"/>		

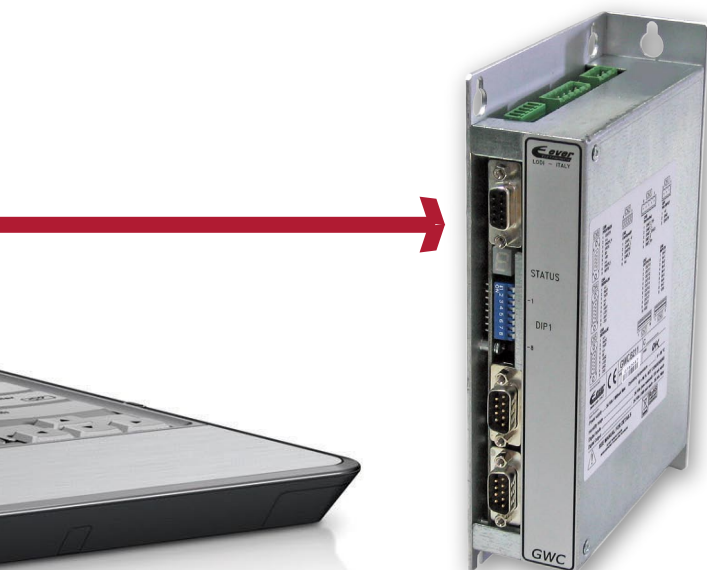

Our history



Our solutions make yours easy

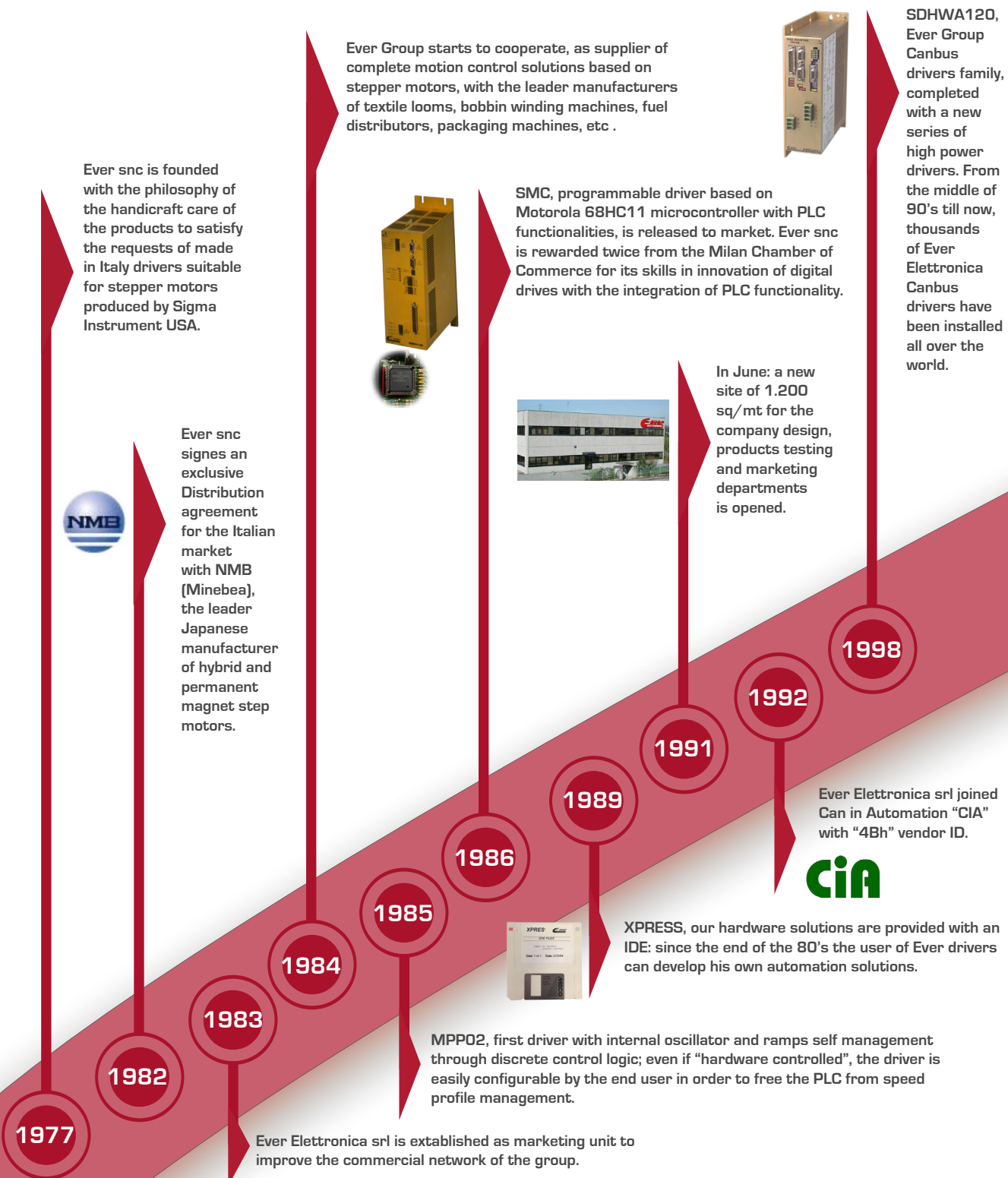

1977

Ever Elettronica srl is established as marketing unit to improve the commercial network of the group.

1982



Ever snc signs an exclusive Distribution agreement for the Italian market with NMB (Minebea), the leader Japanese manufacturer of hybrid and permanent magnet step motors.

1983

1984

1985



Ever Group starts to cooperate, as supplier of complete motion control solutions based on stepper motors, with the leader manufacturers of textile looms, bobbin winding machines, fuel distributors, packaging machines, etc .

1986



MPP02, first driver with internal oscillator and ramps self management through discrete control logic; even if "hardware controlled", the driver is easily configurable by the end user in order to free the PLC from speed profile management.

1989



In June: a new site of 1.200 sq/mt for the company design, products testing and marketing departments is opened.

1991

SMC, programmable driver based on Motorola 68HC11 microcontroller with PLC functionalities, is released to market. Ever snc is rewarded twice from the Milan Chamber of Commerce for its skills in innovation of digital drives with the integration of PLC functionality.

1992



Ever Elettronica srl joined Can in Automation "CIA" with "4Bh" vendor ID.

1998



SDHWA120, Ever Group Canbus drivers family, completed with a new series of high power drivers. From the middle of 90's till now, thousands of Ever Elettronica Canbus drivers have been installed all over the world.



GWC: this master controller, featuring Canbus and Modbus interfaces, Profibus gateway, programmable with IEC1131 ST "TRIPOS" language, helps the integration of Canbus Ever drivers into complex machine control systems.



SDMWD170, for the first time in Italy is released a step motors drive with closed loop control of torque, speed and position.

2002

2003

2005

2007

2008

2012

2013

2015



TITANIO
VECTOR · STEPPER · DRIVES

Our new "state of the art" vector drives based on ARM C. M4 DSP technology.



"High Efficiency" motors. Our new HE hybrid stepper motors line with torque performances 40% higher than standard motors in standard sizes and at same price.

EtherCAT



35 years of activity anniversary is celebrated looking at the future with the registration to CIA ETG and with the first EtherCAT SW1 driver.

eePLC Studio

eePLC, visual programming environment for SW1 drivers with integrated PLC. This software, resulting from our 30-years experience in design of tailored solutions development, can work as unique and user friendly tool to allow our customers to develop themselves complex applications for their machines based on our drives.



Changzhou Ever Electronics Motion Control Technology, chinese AIWEI, is set up as Ever Elettronica srl WOFE to give technical and commercial support to the customers of the Group in Asia market.



Ever Elettronica srl, according to the new manufacturing mission of the branch, sets in its new facility of 2.000 sq/mt in Lodi a SMD and THD components assembly line provided with products ICT and functionality ATE (automatic testing equipments). Our drivers are produced under our direct control; a strategic step forward allowing us to offer to our customers quality, flexibility and fast delivery.



"We were born with Italian electronics for industrial automation and we paced as a protagonist all the technology and global way from the 70's to our days, trying to support our customers not just as a components supplier but as a partner able to provide clever solutions to their automation problems".

Ing. Felice Caldi

EVER snc

Headquarter

Via del Commercio 2/4 - Z.I. San Grato
26900 – Lodi (LO) - ITALY
Tel. ++39 0371 412318
Fax ++39 0371 412367
infoever@everelettronica.it

EVER Elettronica srl

Production Unit

Via del Commercio, 9/11 - Z.I. San Grato
26900 – Lodi (LO) - ITALY
Tel. ++39 0371 413260
Fax ++39 0371 412367

www.everelettronica.it

