

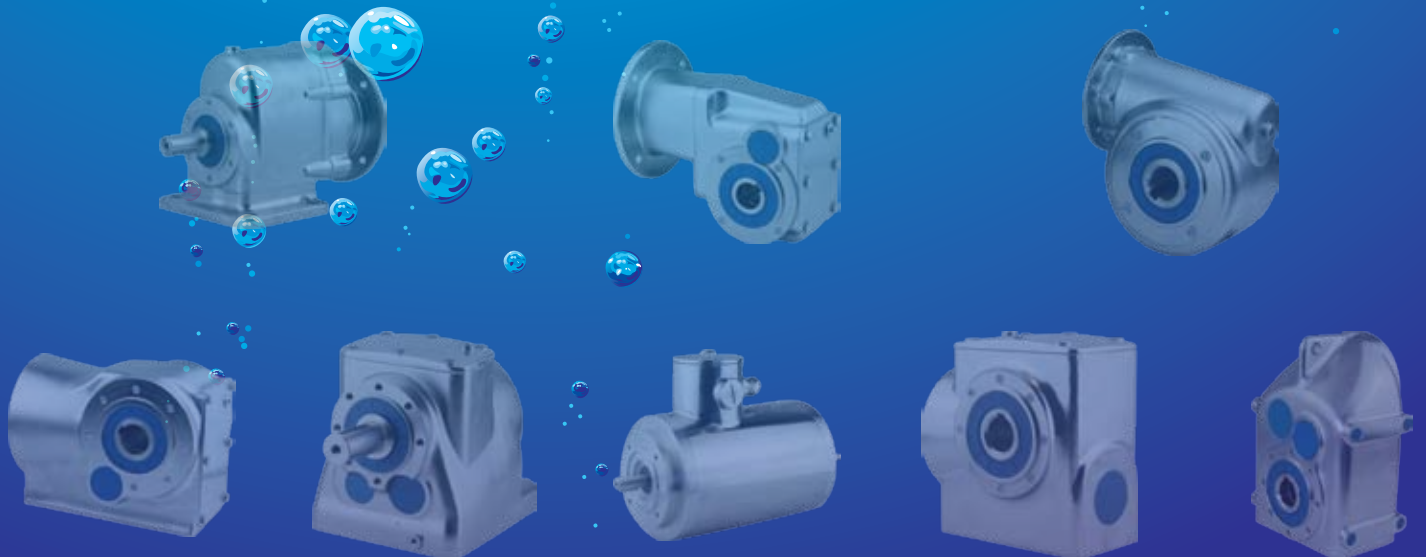

## ***Stainless Steel Helical Gearboxes***

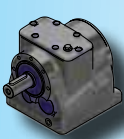



## **FR Series Helical Gearboxes**

*FR series helical gearboxes are being developed to achieve high torque, low energy use and less surface heat.*

*The high efficiency of the drive reduces the energy consumption.*

*The case hardened gears ensure a long lifetime and smooth running.*

*The smart use of 2 stage or 3 stage gearing in the same housing offers a complete spectrum of ratio's to be selected.*

*The footprint and shaft sizes are similar to common used standards in the market.*

*The design of the gearbox is organic round and the smooth design makes the gearboxes extremely applicable in the food industry.*

*The FR helical Gearboxes offer high ratios up to 199,81 : 1 with a maximum output torque of 600 Nm.*

### **The main features are:**

*Made of high quality carefully electro polished Stainless Steel AISI 316. (Mirror Polished on request)*

*The smooth design gives the gearbox a nice appearance, ready to suit all kinds of stainless steel machineries for the food industry.*

*All solid shafts are produced in Duplex Stainless Steel 2205.*

*The special PNS surface treatment ensures enough hardness to collaborate with our Special High Temperature Resistant Blue Shaft Seals.*

*The PNS treatment increases the lifetime of shaft / seal cooperation and helps to reduce wear on the shaft surface.*

*By this, the gearbox obtains a longer drip free operation compared to standard shaft / seal combinations made of SS304 with NBR or FKM.*

*The use of above combination offers all the positive characteristics of stainless steel and the surface hardness of a hardened shaft.*

*Our high performance engineered shaft seals have a Blue colour.*

*It is a well overthought feature for food industry applications.*

*It might be clear that the colour "Blue" is a not existing organic colour.*

*In the context of food safety it is a common use to embed blue colours as these are very visible and easily to be recognised by Vision scanning systems.*

*All gearboxes are standard equipped with NSH H1 certified Synthetic Foodgrade lubrication.*

*On request it can be supplied with a Halal, Kosher or Nut Free certification.*

*To avoid dirt traps under the commonly used motor identification tagplate,*

*all our motors and gearboxes are being equipped with a laser engraved tagplate.*

*Besides for the food safety this also prevents against possible lost of information because of taking away the tagplate or loosing the tagplate from the driveparts.*

*As a part of our standard procedure every drive is tested in our production facility in the Netherlands to ensure correct functioning.*

### **Properties and features :**

*Standard ratio's 3,41 : 1 to 199,81 : 1*

*IEC motor adaption or with integrated motor*

*Standard solid shafts 25, 30 & 35 mm*

*Easy clean torque arm with built in elastic element to reduce alignment mistakes allows easy assembling of the gearbox on the machine shaft.*

*There is no need to laser cut and bend your own torque arm.*

*The Easy clean torque arm has a very open design. This design offers better cleanability during the standard cleaning cycle.*

*For flange mounted applications we offer several types of secondary output flanges in Electro Polished SS316.*

*As a problem solver we are happy to investigate the best possible solutions for our customers that fits their budget.*

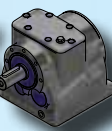

<b>FR 38</b>		<b>FR 48</b>	
Ratio's	3.41 : 1 up to 134.82 : 1	Ratio's	3.83 : 1 up to 176.88 : 1
Standard shaft	25 mm	Standard shaft	30 mm
Torque	Max. 200 Nm	Torque	Max. 300 Nm
Power	Max. 3.0 kW	Power	Max. 4.0 kW
<b>FR 68</b>			
Ratio's	4.29 : 1 up to 199.81 : 1		
Standard shaft	35 mm		
Torque	Max. 600 Nm		
Power	Max. 7.5 kW		



*Output Flanges*

*Under Development*



## Power P

This parameter can be found in the gearbox selection tables and represents the amount kW that can be safely transmitted into the gearbox

$$P_1 = \frac{P_2}{\eta} \text{ [kW]}$$

$$P_{1n} \geq P_1 \cdot f_s \text{ [kW]}$$

- $P_1$       Input Power (kW)
- $P_2$       Output Power (kW)
- $P_{1n}$      Rated Input Power (kW)
- $f_s$       Service Factor
- $\eta$         Transmission Efficiency %

## Rotation Speed n

- $n_1$       Gear Units Input Speed
- $n_2$       Gear Units Output Speed

All stated values are based on an input speed of 1500 min<sup>-1</sup>.  
We strongly advise, to obtain the expected lifetime, not to exceed the maximum input speed.  
In case of a lower input speed the maximum input torque should be taken in consideration too.

## Transmission ratio i

$$i = \frac{n_1}{n_2}$$

## Torque M

$$M_2 = \frac{9550 \cdot P_1 \cdot \eta}{n_2} \text{ [Nm]}$$

$$M_{2n} \geq M_2 \cdot f_s \text{ [Nm]}$$

- $M_2$       = Output Torque (Nm)
- $M_{2n}$     = Selected Output Torque (Nm)
- $P_1$       = Input Power (kW)
- $\eta$         = Transmission Efficiency %
- $f_s$       = Service Factor

## Efficiency of gear units

The efficiency of gear units is mainly determined by the gearing and bearing friction. Keep in mind that the starting efficiency of a gear unit is always less than its efficiency at operating speed. This factor is particularly distinctive for worm & helical worm gear boxes.  
The gearing in helical worm & worm gearboxes produces a high proportion of sliding friction.  
As a result these gearboxes have higher gear efficiency losses than other gearboxes and therefore have a lower total efficiency.  
A secondary result is that the surface temperature of these gearboxes will be higher than other gearboxes.  
The efficiency of the Dertec Stainless Steel gearboxes can be found in the possible geometrical combinations page's of each gearbox serie.



## Service Factor

The effect of the driven machine on the gearbox is taken into account to a sufficient level of accuracy using the Service Factor  $f_s$ .

The Service Factor is determined according to the daily operating time and the starting frequency  $Z$ .

Three load classifications are considered depending on the mass acceleration factor.

You can read of the service factor applicable to your application in the figure below.

The service factor selected using this figure must be less than or equal to the service factor as given in the gearbox selection table.

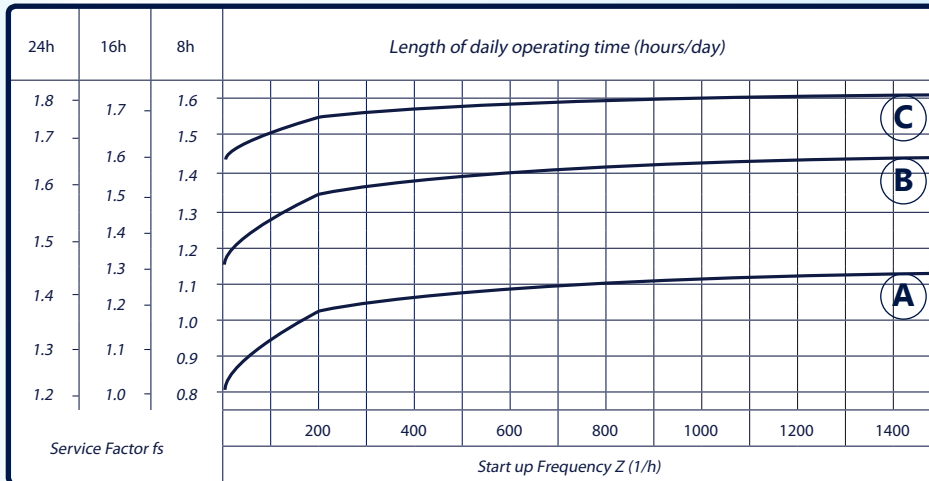

## Service Factor for wormgearboxes

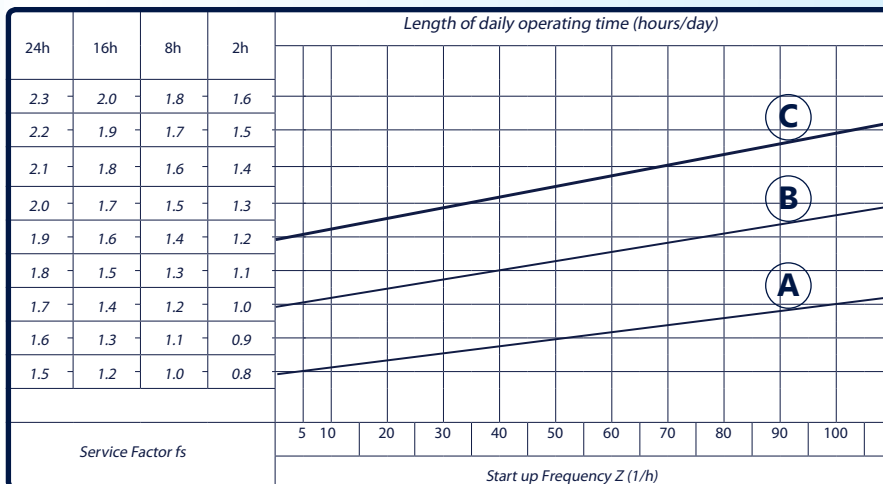

### Ambient temperature influence on the service factor for wormgearboxes

Service factor  $f_s$  should be adjusted as following

ambient temperature = 30 ~ 40 :  $f_s \times 1.1 \sim 1.2$

ambient temperature = 40 ~ 50 :  $f_s \times 1.3 \sim 1.4$

ambient temperature = 50 ~ 60 :  $f_s \times 1.5 \sim 1.6$

ambient temperature = > 60, please contact Dertec.

### Type of load:

**A**

Uniform load Permitted mass acceleration factor ( $f_a$ )  $\leq 0.3$

Screw feeders for light materials, fans, assembly lines, conveyor belts for light materials, small mixers, lifts, cleaning machines, fillers, control machines.

**B**

Moderate shock load Permitted mass acceleration factor ( $f_a$ )  $\leq 3$

Winding devices, woodworking machine feeders, goods lifts, balancers, threading machines, medium mixers, conveyor belts for heavy materials, winches, sliding doors, fertilizer scrapers, packing machines, concrete mixers, crane mechanism, milling cutters, folding machines, gear pumps.

**C**

Heavy Shock Load Permitted mass acceleration factor ( $f_a$ )  $\leq 10$

Mixers for heavy materials, shears, presses, centrifuges, rotating supports, winches and lifts for heavy materials, grinding lathes, stone mills, bucket elevators, drilling machines, hammer mills, cam presses, folding machines, turntables, tumbling barrels, vibrators, shredders.

**To maintain the service life of the gear units, the Service Factor mentioned in the gearbox selection table must be equal or slightly higher than the calculated service factor.**



## Mass Acceleration Factor

The Mass acceleration factor is calculated as follows:

$$f_a = \frac{J_c}{J_m}$$

$f_a$  = Mass Acceleration Factor

$J_c$  = All External Mass Moments Of Inertia [Kgm<sup>2</sup>]

$J_m$  = Mass Moment Of Inertia on the Motor End [Kgm<sup>2</sup>]

If the mass acceleration factor is  $f_a > 10$ , please contact us.

## Overhung and axial loads

### Determining overhung loads

An important factor for determining the resulting overhung load is the type of transmission element mounted to the shaft end. The following transmission element factors  $f_z$  have to be considered for various transmission elements.

Transmission Element	Transmission Element Factor Fz	Comments
Gears	1.00	≥ 17 Teeth
	1.15	< 17 Teeth
Chain Sprockets	1.00	≥ 20 Teeth
	1.25	< 20 Teeth
	1.40	< 13 Teeth
Narrow V-belt pulleys	1.75	Influence of the tensile force
Flat Belt Pulleys	2.50	Influence of the tensile force
Toothed Belt Pulleys	2.50	Influence of the tensile force

The overhung load exerted on the motor or gearshaft is calculated as follows

$$F_r = \frac{M \cdot 2000}{d_0} \cdot f_z$$

$F_r$  = Overhung load in N

$M$  = Torque in Nm

$d_0$  = Mean Diameter of the mounted transmission element in mm

$f_z$  = Transmission element factor

### Permitted overhung load

The basis for determining the permitted overhung loads is the calculation of the rated bearing service life  $L_{10h}$  of the roller bearings (according ISO281)

For special operating conditions, the permitted overhung loads can be determined with regard to the modified service life on request.

The values refer to force applied to the center of the shaft end (in right angle gear units as viewed onto drive end)

The values for the force application angle  $\alpha$  and direction of rotation are based on the most unfavorable conditions.

### Definition of force application

The force application is defined according to the following figure.

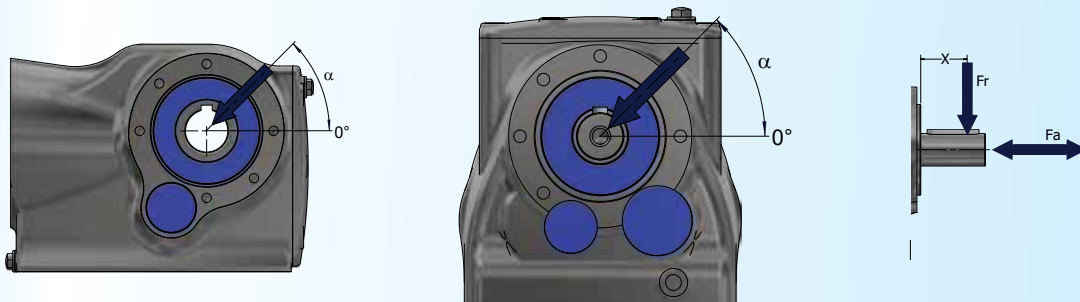

$F_x$  = Permitted overhung load at point x [N]

$F_a$  = Permitted axial load [N]

**Permitted axial forces**

If there is no overhung load, than an axial force  $F_a$  (Tension or Compression) amounting to 50% of the overhung load given in the selection tables is permitted.

**Overhung load conversion for off-center force application**

The permitted overhung loads must be calculated according to the selection tables using the following formula in the event that force is not applied at the center of the shaft end. Note that the calculations apply to  $M2_{max}$ .

**$F_{xl}$  based on bearing life:**

$$F_{xl} = F_{r2} \cdot \frac{a}{b + x} [N]$$

$F_{r2}$  = Permitted overhung load ( $x = L/2$ ) for foot mounted gear units according to the selection tables in [N]

$X$  = Distance from the shaft shoulder to the force application point in [mm]

$a, b$ , = Gear unit constant for overhung load conversions [mm]

The following figure shows the overhung load  $F_r$  with increased distance  $X$  to the gear unit.

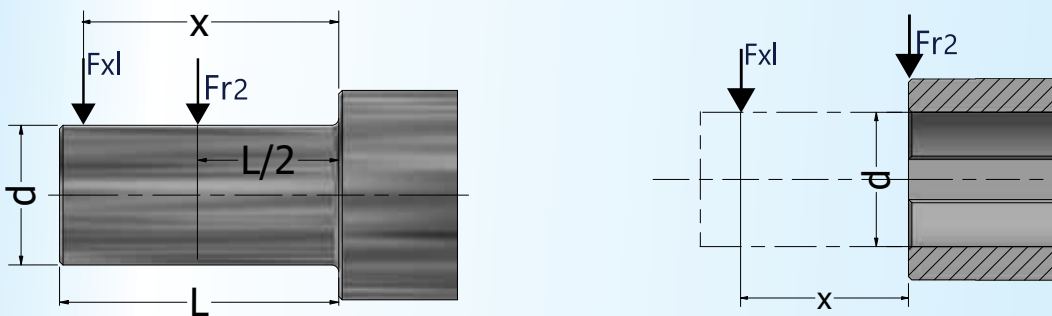

Values of  $a$  &  $b$  in mm are given in the following table

<b>FV</b>	<b>a</b>	<b>b</b>	<b>FR</b>	<b>a</b>	<b>b</b>
<b>FV 030</b>	65	50	<b>FR 38</b>	118	93
<b>FV 040</b>	84	64	<b>FR 48</b>	137	107
<b>FV 050</b>	101	76	<b>FR 68</b>	168.5	133.5
<b>FV 063</b>	12	95			
<b>FK</b>	<b>a</b>	<b>b</b>	<b>FS(A)</b>	<b>a</b>	<b>b</b>
<b>FK 28 B/C</b>	104	78	<b>FS(A) 38</b>	118.5	98.5
<b>FK 38 B/C</b>	118	93	<b>FS(A) 48</b>	130	105
<b>FK 48 B/C</b>	131	101	<b>FS(A) 58</b>	150	120
<b>FK 58 B/C</b>	159	119	<b>FS(A) 68</b>	184	149
<b>FRC</b>	<b>a</b>	<b>b</b>	<b>FKA</b>	<b>a</b>	<b>b</b>
<b>FRC 01</b>	103	83	<b>FKA 38</b>	123.5	98.5
<b>FRC 02</b>	116.5	91.5	<b>FKA 48</b>	153.5	123.5
<b>FRC 03</b>	130	100	<b>FKA 68</b>	181.3	141.3
<b>FFA</b>	<b>a</b>	<b>b</b>	<b>FKA 78</b>	215.8	165.8
<b>FFA 38</b>	123.5	98.5	<b>FKA 88</b>	252	192
<b>FFA 48</b>	153.5	123.5			
<b>FFA 68</b>	181.3	141.3			
<b>FFA 78</b>	215.8	165.8			



## Efficiency & Irreversibility Characteristics

Efficiency is an important parameter of a wormgear reducer.  
Efficiency  $\eta$  depends on the following parameters:

- 1) Helix angle of gearing
- 2) Driving speed
- 3) Running in of gearing
- 4) The performance of the Lubricant, Oil Seals and Bearings.

The Mesh table shows the dynamic efficiency ( $\eta_1=1400$ ) and static efficiency values.

Remember that these values are only achieved after the unit has been operating for ca. 24 hours. "Run in period"

Torque values  $M_{2n}$  indicated in the gearbox selection tables are calculated by considering the steady state performance of the gearboxes.  
The actual values mentioned could have deflection.

### Dynamic Irreversibility

Dynamic Irreversibility is achieved when the output shaft stops instantly when power is no longer transmitted through the wormshaft.  
This condition requires a dynamic efficiency of  $\eta_d < 0.4$ . See mesh table.

$\eta_d$	> 0.6	0.5 ~ 0.6	0.4 ~ 0.5	< 0.4
Dynamic irreversibility	Dynamic reversibility	Low Dynamic reversibility	Good Dynamic irreversibility	Dynamic irreversibility

### Static Irreversibility

Static Irreversibility is achieved when, at a standstill, the application of a load to the output shaft can't drive the wormshaft of the gear reducer.  
This condition requires a static efficiency of  $\eta_s < 0.5$ . See mesh table.

$\eta_s$	> 0.55	0.5 ~ 0.55	< 0.5
Static irreversibility	Static reversibility	Low Static reversibility	Static irreversibility

The table shows approximate irreversibility classes. Vibrations and shocks can effect a gear reducers irreversibility.

As it is virtual impossible to provide and guarantee total non reversing, we recommend the use of an external brake with sufficient capability to prevent vibrations in duced starting, where these circumstances are required.

For the irreversibility conditions of a combined geared unit one must consider that the efficiency of the group is given by the product of the efficiencies of each single reducer, i.e.:  $N_{tot} = N1 \times N2$

## Mesh Data

	$i$	7,5	10	15	20	25	30	40	50	60	80	100
<b>FV 030</b>	<b>z1</b>	4	3	2	2	1	1	1	1	1	1	
	<b>Mn</b>	1.36	1.39	1.42	1.09	1.69	1.43	1.10	0.89	0.74	0.56	
	<b>Y</b>	18°55'	14°25'	9°44'	7°50'	5°33'	4°54'	3°56'	3°17'	2°43'	2°7'	
	$\eta_d$	0.84	0.81	0.76	0.72	0.66	0.64	0.59	0.54	0.50	0.44	
	$\eta_s$	0.66	0.62	0.54	0.49	0.41	0.38	0.33	0.29	0.26	0.21	
<b>FV 040</b>	<b>z1</b>	4	3	2	2	2	1	1	1	1	1	1
	<b>Mn</b>	1.87	1.95	2.00	1.54	1.26	2.04	1.55	1.27	1.06	0.80	0.65
	<b>Y</b>	23°54'	18°23'	12°30'	10°3'	8°45'	6°19'	5°4'	4°24'	3°42'	2°52'	2°29'
	$\eta_d$	0.86	0.84	0.80	0.77	0.74	0.69	0.65	0.61	0.57	0.51	0.47
	$\eta_s$	0.70	0.66	0.59	0.54	0.51	0.44	0.39	0.36	0.32	0.27	0.24
<b>FV 050</b>	<b>z1</b>	4	3	2	2	2	1	1	1	1	1	1
	<b>Mn</b>	2.34	2.43	2.50	1.92	1.56	2.54	1.94	1.58	1.32	1.00	0.80
	<b>Y</b>	23°49'	18°19'	12°27'	10°3'	8°33'	6°18'	5°4'	4°18'	3°38'	2°52'	2°17'
	$\eta_d$	0.87	0.85	0.81	0.78	0.75	0.71	0.67	0.63	0.59	0.53	0.48
	$\eta_s$	0.70	0.66	0.59	0.54	0.51	0.44	0.39	0.36	0.32	0.27	0.24
<b>FV 063</b>	<b>z1</b>	4	3	2	2	2	1	1	1	1	1	1
	<b>Mn</b>	2.96	3.08	3.17	2.44	1.98	3.23	2.47	1.99	1.68	1.27	1.02
	<b>Y</b>	24°31'	18°53'	12°51'	10°29'	8°45'	6°30'	5°17'	4°24'	3°49'	2°59'	2°26'
	$\eta_d$	0.88	0.86	0.82	0.80	0.77	0.73	0.69	0.65	0.62	0.56	0.51
	$\eta_s$	0.70	0.66	0.59	0.55	0.51	0.44	0.40	0.36	0.33	0.28	0.24



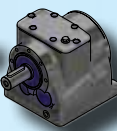

$P_{1n}$ [kW]	$N_2$ $\text{min}^{-1}$	$M_{2n}$ [Nm]	$i$	$F_{r2}$ [N]	$f_s$		
------------------	----------------------------	------------------	-----	-----------------	-------	---	---



= **Combination with the motor in the header row is not possible**

= **Combination with the motor in the header row is possible**

$P_{1n}$  [kW] = **Rated Motor Power [kW]**

$N_2 \text{ min}^{-1}$  = **Output Speed [ $\text{min}^{-1}$ ]**

$M_{2n}$  [Nm] = **Rated Output torque [Nm]**

$M_{2\text{Max}}$  = **Maximum permissible output torque [Nm]**

$F_{r2}$  [N] = **Permitted Overhung Load Output Side [N]**

$i$  = **Gear unit Ratio**

$f_s$  = **Service Factor**



= **Gear unit type**

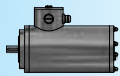

= **Motor Type**

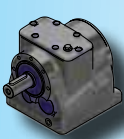

FR 38

Maximum Torque = 200 Nm @ N1 = 1400r/min

N2 min <sup>-1</sup>	M2max [Nm]	Fr2 [N]	i	η %	63/71 B5T1 IEC 63/71 AM	80 B5T1 IEC 80 AM	90 B5T1 IEC 90 AM	100 B5T1 IEC 100 AM
<b>3 Stage</b>								
10	200	4950	134.82	94				
11	200	4950	123.66	94				
13	200	4950	105.28	94				
15	200	4950	90.77	94				
17	200	4950	84.61	94				
19	200	4950	73.96	94				
20	200	4950	69.33	94				
23	200	4950	61.18	94				
25	200	4950	55.76	94				
29	200	4950	48.08	94				
31	200	4950	44.81	94				
36	200	4760	39.17	94				
38	200	4540	36.72	94				
43	200	4120	32.40	94				
49	200	3740	28.73	94				
57	200	3240	24.42	94				
<b>2 Stage</b>								
49	200	3690	28.32	96				
54	185	3860	26.03	96				
63	200	2970	22.27	96				
73	200	2570	19.31	96				
78	200	2390	18.05	96				
90	200	2010	15.60	96				
106	190	1880	13.25	96				
118	183	1810	11.83	96				
138	170	1820	10.11	96				
148	167	1760	9.47	96				
176	156	1720	7.97	96				
210	144	1000	6.67	96				
247	142	760	5.67	96				
277	135	790	5.06	96				
324	126	820	4.32	96				
346	122	850	4.05	96				
411	112	900	3.41	96				

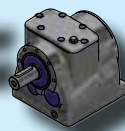

FR 48

Maximum Torque = 300 Nm @ N1 = 1400r/min

N2 min <sup>-1</sup>	M2max [Nm]	Fr2 [N]	i	$\eta$ %	63/71 B5T2 IEC 63/71 AM	80 B5T2 IEC 80 AM	90 B5T2 IEC 90 AM	100 B5T2 IEC 100 AM	112 B5T2 IEC 112 AM	132 B5T2 IEC 132 AM
<b>3 Stage</b>										
7.9	300	5420	176.88	94						
8.6	300	5420	162.94	94						
10	300	5420	139.99	94						
11	300	5420	121.87	94						
12	300	5420	114.17	94						
14	300	5420	100.86	94						
15	300	5420	93.68	94						
16	300	5420	84.90	94						
18	300	5420	76.23	94						
20	300	5420	68.54	94						
22	300	5420	64.21	94						
25	300	5420	56.73	94						
27	300	5350	52.69	94						
29	300	5150	47.75	94						
33	300	4930	42.87	94						
38	300	4630	36.93	94						
40	300	4520	34.73	94						
47	300	4240	29.88	94						
52	300	4050	26.70	94						
59	300	3840	23.59	94						
<b>2 Stage</b>										
41	240	4690	33.79	96						
45	220	4610	31.12	96						
52	300	4050	26.74	96						
60	300	3820	23.28	96						
64	300	3710	21.81	96						
73	295	3530	19.27	96						
78	290	3390	17.89	96						
86	275	3350	16.22	96						
96	265	3230	14.56	96						
112	250	3080	12.54	96						
119	245	3020	11.79	96						
138	230	2890	10.15	96						
154	220	2780	9.07	96						
175	205	2690	8.01	96						
180	163	2720	7.76	96						
201	159	2620	6.96	96						
233	156	2470	6.00	96						
248	155	2410	5.64	96						
289	150	2280	4.85	96						
323	146	2190	4.34	96						
366	144	2090	3.83	96						

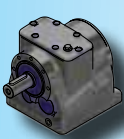



FR 68

Maximum Torque = 600 Nm @ N1 = 1400r/min

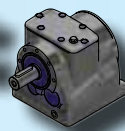
N2 min <sup>-1</sup>	M2max [Nm]	Fr2 [N]	i	η %	63/71 B5T2 IEC 63/71 AM	80 B5T2 IEC 80 AM	90 B5T2 IEC 90 AM	100 B5T2 IEC 100 AM	112 B5T2 IEC 112 AM	132 B5T2 IEC 132 AM
<b>3 Stage</b>										
7.0	600	7560	199.81	94						
7.6	600	7560	184.07	94						
8.9	600	7560	158.14	94						
10	600	7560	137.67	94						
11	600	7560	128.97	94						
12	600	7560	113.94	94						
13	600	7560	105.83	94						
15	600	7560	95.91	94						
16	600	7560	86.11	94						
19	600	7560	74.17	94						
20	600	7560	69.75	94						
23	600	7560	61.26	94						
25	600	7560	56.89	94						
27	600	7560	51.56	94						
30	600	7560	46.29	94						
35	580	7790	39.88	94						
37	570	7900	37.50	94						
43	540	8210	32.27	94						
49	520	8400	28.83	94						
<b>2 Stage</b>										
50	540	8210	28.13	96						
52	540	8210	26.72	96						
60	560	8010	23.44	96						
70	600	7560	19.89	96						
78	590	7330	17.95	96						
89	560	7130	15.79	96						
94	550	6980	14.91	96						
110	520	6650	12.70	96						
121	500	6500	11.54	96						
140	470	6220	10.00	96						
161	440	5960	8.70	96						
180	380	5830	7.79	96						
190	370	5790	7.36	96						
223	330	5590	6.27	96						
246	310	5450	5.70	96						
284	290	5210	4.93	96						
326	270	5000	4.29	96						



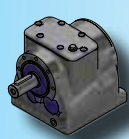

$P_{1n}$ [kW]	$N_2$ $\text{min}^{-1}$	$M_{2n}$ [Nm]	$i$	$F_{r2}$ [N]	$f_s$		
<b>0.12</b>	6.9	166	199.81	10300	3.60	<b>FR 68 AM63</b> <b>FR 68 B5T2</b>	<b>631-4 B5</b> <b>631-4 B5T2</b>
	7.5	153	184.07	10400	3.90		
<b>0.18</b>	9.8	176	134.82	5230	1.15	<b>FR 38 AM63</b> <b>FR 38 B5T1</b>	<b>632-4 B5</b> <b>632-4 B5T1</b>
	11	161	123.66	5370	1.25		
	13	137	105.28	5580	1.45		
	15	118	90.77	5710	1.70		
	16	110	84.61	5760	1.80		
	18	96	73.96	5840	2.10		
	19	90	69.33	5870	2.20		
	22	80	61.18	5920	2.50		
	24	73	55.76	5940	2.80		
	27	63	48.08	5960	3.20		
	9.6	179	90.77	5190	1.10	<b>FR 38 AM71</b> <b>FR 38 B5T1</b>	<b>711-6 B5</b> <b>711-6 B5T1</b>
	10	167	84.61	5310	1.20		
	7.5	230	176.88	5740	1.30	<b>FR 48 AM63</b> <b>FR 48 B5T2</b>	<b>632-4 B5</b> <b>632-4 B5T2</b>
	8.1	210	162.94	5810	1.40		
	9.4	182	139.99	5910	1.65		
	11	159	121.87	5980	1.90		
	12	149	114.17	6000	2.00		
	13	131	100.86	6040	2.30		
	14	122	93.68	6060	2.50		
	16	111	84.90	6080	2.70		
	17	99	76.23	6100	3.00		
	6.6	260	199.81	10100	2.30	<b>FR 68 AM63</b> <b>FR 68 B5T2</b>	<b>632-4 B5</b> <b>632-4 B5T2</b>
	7.2	240	184.07	10100	2.50		
8.3	205	158.14	10200	2.90			
9.6	179	137.67	10300	3.40			
10	168	128.97	10300	3.60			
12	148	113.94	10400	4.00			
12	138	105.83	10400	4.40			

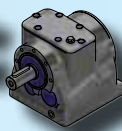

$P_{1n}$ [kW]	$N_2$ $\text{min}^{-1}$	$M_{2n}$ [Nm]	$i$	$F_{r2}$ [N]	$f_s$		
<b>0.18</b>	4.4	395	199.81	9370	1.50	<b>FR 68 AM71</b> <b>FR 68 B5T2</b>	<b>711-6 B5</b> <b>711-6 B5T2</b>
	4.7	365	184.07	9560	1.65		
	5.5	310	158.14	9830	1.90		
	6.3	270	137.67	10000	2.20		
	6.8	255	128.97	10100	2.40		
	7.6	225	113.94	10200	2.70		
	8.2	210	105.83	10200	2.90		
	9.1	190	95.91	10300	3.20		
	10	170	86.11	10300	3.50		
	12	147	74.17	10400	4.10		
	12	138	69.75	10400	4.40		
<b>0.25</b>	12	193	105.28	5030	1.05	<b>FR 38 AM71</b> <b>FR 38 B5T1</b>	<b>711-4 B5</b> <b>711-4 B5T1</b>
	14	167	90.77	5320	1.20		
	15	155	84.61	5420	1.30		
	18	136	73.96	5590	1.45		
	19	127	69.33	5650	1.55		
	21	112	61.18	5750	1.80		
	23	102	55.76	5800	1.95		
	27	88	48.08	5870	2.30		
	29	82	44.81	5760	2.40		
	33	72	39.17	5540	2.80		
	35	67	36.72	5430	3.00		
	40	60	32.40	5230	3.40		
	8.0	300	162.94	5420	1.00	<b>FR 48 AM71</b> <b>FR 48 B5T2</b>	<b>711-4 B5</b> <b>711-4 B5T2</b>
	9.3	255	139.99	5630	1.15		
	11	225	121.87	5770	1.35		
	11	210	114.17	5820	1.45		
	13	185	100.86	5900	1.60		
	14	172	93.68	5940	1.75		
	15	156	84.90	5980	1.90		
	17	140	76.23	6020	2.10		
	19	126	68.54	6050	2.40		
	20	118	64.21	6070	2.50		
	23	104	56.73	6090	2.90		
	25	97	52.69	6100	3.10		
	27	88	47.75	6080	3.40		
	6.5	365	199.81	9540	1.65	<b>FR 68 AM71</b> <b>FR 68 B5T2</b>	<b>711-4 B5</b> <b>711-4 B5T2</b>
	7.1	340	184.07	9700	1.80		
	8.2	290	158.14	9930	2.10		
	9.4	255	137.67	10100	2.40		
	10	235	128.97	10100	2.50		
11	210	113.94	10200	2.90			
12	194	105.83	10300	3.10			
14	176	95.91	10300	3.40			
15	158	86.11	10400	3.80			



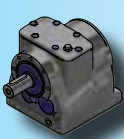

$P_{1n}$ [kW]	$N_2$ $\text{min}^{-1}$	$M_{2n}$ [Nm]	$i$	$F_{r2}$ [N]	$f_s$		
<b>0.25</b>	4.4	540	199.81	8190	1.10	<b>FR 68 AM71</b> <b>FR 68 B5T2</b>	<b>712-6 B5</b> <b>712-6 B5T2</b>
	4.8	500	184.07	8590	1.20		
	5.6	430	158.14	9140	1.40		
	6.4	375	137.67	9500	1.60		
	6.8	350	128.97	9630	1.70		
	7.7	310	113.94	9840	1.95		
	8.3	285	105.83	9940	2.10		
	4.3	555	158.14	8060	1.10		
	4.9	485	137.67	8730	1.25		
	5.3	455	128.97	8970	1.35		
6.0	400	113.94	9340	1.50			
<b>0.37</b>	19	189	73.96	5070	1.05	<b>FR 38 AM71</b> <b>FR 38 B5T1</b>	<b>712-4 B5</b> <b>712-4 B5T1</b>
	20	178	69.33	5210	1.15		
	23	157	61.18	5410	1.30		
	25	143	55.76	5530	1.40		
	29	123	48.08	5590	1.60		
	31	115	44.81	5480	1.75		
	35	100	39.17	5290	2.00		
	38	94	36.72	5190	2.10		
	43	83	32.40	5010	2.40		
	48	74	28.73	4850	2.70		
	57	63	24.42	4620	3.20		
	49	73	28.32	4830	2.80		
	53	67	26.03	4710	2.80		
	62	57	22.27	4500	3.50		
	71	49	19.31	4320	4.10		
	76	46	18.05	4230	4.30		
	88	40	15.60	4050	5.00		
	104	34	13.25	3850	5.60		
	117	30	11.83	3720	6.00		
	12	290	114.17	5460	1.05		
	14	260	100.86	5630	1.15		
	15	240	93.68	5700	1.25		
	16	215	84.90	5790	1.40		
	18	195	76.23	5870	1.55		
	20	176	68.54	5930	1.70		
	21	164	64.21	5960	1.80		
	24	145	56.73	6010	2.10		
	26	135	52.69	5990	2.20		
	29	122	47.75	5820	2.50		
	32	110	42.87	5650	2.70		
	37	95	36.93	5410	3.20		
	40	89	34.73	5310	3.40		
	41	87	33.79	5270	2.80		
44	80	31.12	5150	2.80			
52	69	26.74	4920	4.40			
59	60	23.28	4720	5.00			
63	56	21.81	4620	5.40			
						<b>FR 48 AM71</b> <b>FR 48 B5T2</b>	<b>712-4 B5</b> <b>712-4 B5T2</b>



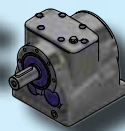

$P_{1n}$ [kW]	$N_2$ $\text{min}^{-1}$	$M_{2n}$ [Nm]	$i$	$F_{r2}$ [N]	$f_s$		
<b>0.37</b>	6.9	510	199.81	8480	1.15	<b>FR 68 AM71</b> <b>FR 68 B5T2</b>	<b>712-4 B5</b> <b>712-4 B5T2</b>
	7.5	470	184.07	8820	1.25		
	8.7	405	158.14	9310	1.50		
	10	355	137.67	9620	1.70		
	11	330	128.97	9740	1.80		
	12	290	113.94	9920	2.10		
	13	270	105.83	10000	2.20		
	14	245	95.91	10100	2.40		
	16	220	86.11	10200	2.70		
	19	190	74.17	10300	3.20		
	20	179	69.75	10300	3.40		
	23	157	61.26	10400	3.80		
	24	146	56.89	10400	4.10		
	6.5	540	137.67	8210	1.10		
	7.0	505	128.97	8530	1.20		
7.9	445	113.94	9010	1.35			
<b>0.55</b>	28	186	48.08	5120	1.10	<b>FR 38 AM80</b> <b>FR 38 B5T1</b>	<b>801-4 B14a</b> <b>801-4 B5T1</b>
	30	173	44.81	5230	1.15		
	35	151	39.17	5070	1.30		
	37	142	36.72	4990	1.40		
	42	125	32.40	4840	1.60		
	47	111	28.73	4700	1.80		
	56	94	24.42	4500	2.10		
	61	86	22.27	4390	2.30		
	70	75	19.31	4220	2.70		
	75	70	18.05	4140	2.90		
	87	60	15.60	3970	3.30		
	103	51	13.25	3790	3.70		
	115	46	11.83	3670	4.00		
	18	295	76.23	5450	1.00		
	20	265	68.54	5600	1.15		
	21	250	64.21	5670	1.20		
	24	220	56.73	5790	1.35		
	26	205	52.69	5770	1.45		
	28	184	47.75	5630	1.65		
	32	166	42.87	5470	1.80		
	37	143	36.93	5260	2.10		
	39	134	34.73	5180	2.20		
	46	115	29.88	4970	2.60		
	51	103	26.74	4820	2.90		
	58	90	23.28	4630	3.30		
62	84	21.81	4550	3.60			
						<b>FR 48 AM80</b> <b>FR 48 B5T2</b>	<b>801-4 B14a</b> <b>801-4 B5T2</b>





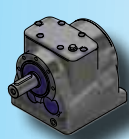

$P_{1n}$ [kW]	$N_2$ $min^{-1}$	$M_{2n}$ [Nm]	$i$	$F_{r2}$ [N]	$f_s$		
<b>0.55</b>	8.6	610	158.14	7430	1.00	<b>FR 68 AM80</b> <b>FR 68 B5T2</b>	<b>801-4 B14a</b> <b>801-4 B5T2</b>
	9.9	530	137.67	8290	1.15		
	11	500	128.97	8600	1.20		
	12	440	113.94	9060	1.35		
	13	410	105.83	9280	1.45		
	14	370	95.91	9520	1.60		
	16	335	86.11	9730	1.80		
	18	285	74.17	9940	2.10		
	20	270	69.75	10000	2.20		
	22	235	61.26	10100	2.50		
24	220	56.89	10200	2.70			
<b>0.75</b>	35	205	39.17	4720	1.00	<b>FR 38 AM80</b> <b>FR 38 B5T1</b>	<b>802-4 B14a</b> <b>802-4 B5T1</b>
	38	191	36.72	4740	1.05		
	43	168	32.40	4610	1.20		
	48	149	28.73	4490	1.35		
	57	127	24.42	4320	1.60		
	62	116	22.27	4230	1.75		
	71	100	19.31	4080	2.00		
	76	94	18.05	4010	2.10		
	88	81	15.60	3850	2.50		
	104	69	13.25	3690	2.80		
	117	61	11.83	3570	3.00		
	137	53	10.11	3420	3.20		
	146	49	9.47	3360	3.40		
	24	295	56.73	5450	1.00	<b>FR 48 AM80</b> <b>FR 48 B5T2</b>	<b>802-4 B14a</b> <b>802-4 B5T2</b>
	26	275	52.69	5480	1.10		
	29	250	47.75	5370	1.20		
	32	225	42.87	5240	1.35		
	37	192	36.93	5060	1.55		
	40	180	34.73	4980	1.65		
	46	155	29.88	4800	1.95		
	52	139	26.70	4660	2.20		
	58	122	23.59	4510	2.50		
	52	139	26.74	4660	2.20		
	59	121	23.28	4490	2.50		
	63	113	21.81	4420	2.70		
	72	100	19.27	4270	3.00		
	77	93	17.89	4180	3.10		
	85	84	16.22	4070	3.30		
	12	590	113.94	7660	1.00	<b>FR 68 AM80</b> <b>FR 68 B5T2</b>	<b>802-4 B14a</b> <b>802-4 B5T2</b>
	13	550	105.83	8120	1.10		
	14	500	95.91	8600	1.20		
	16	445	86.11	9010	1.35		
	19	385	74.17	9430	1.55		
20	360	69.75	9570	1.65			
23	320	61.26	9800	1.90			
24	295	56.89	9910	2.00			
27	270	51.56	10000	2.20			
30	240	46.29	10100	2.50			



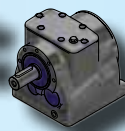

$P_{1n}$ [kW]	$N_2$ $\text{min}^{-1}$	$M_{2n}$ [Nm]	$i$	$F_{r2}$ [N]	$f_s$		
<b>1.1</b>	57	183	24.42	3720	1.10	<b>FR 38 AM90</b> <b>FR 38 B5T1</b>	<b>90S-4 B14a</b> <b>90S-4 B5T1</b>
	73	145	19.31	3840	1.40		
	78	135	18.05	3790	1.50		
	90	117	15.60	3660	1.70		
	106	99	13.25	3520	1.90		
	118	89	11.83	3430	2.10		
	139	76	10.11	3290	2.20		
	148	71	9.47	3230	2.40		
	176	60	7.97	3090	2.60		
	210	50	6.67	2920	2.90		
	247	43	5.67	2790	3.30		
	277	38	5.06	2700	3.60		
	38	275	36.93	4720	1.10	<b>FR 48 AM90</b> <b>FR 48 B5T2</b>	<b>90S-4 B14a</b> <b>90S-4 B5T2</b>
	40	260	34.73	4660	1.15		
	47	225	29.88	4520	1.35		
	52	200	26.70	4410	1.50		
	59	177	23.59	4290	1.70		
	60	175	23.28	4270	1.70		
	64	164	21.81	4210	1.85		
	73	145	19.27	4080	2.00		
	78	134	17.89	4010	2.20		
	86	122	16.22	3910	2.30		
	96	109	14.56	3800	2.40		
	112	94	12.54	3650	2.70		
	119	89	11.79	3590	2.80		
	138	76	10.15	3450	3.00		
	154	68	9.07	3340	3.20		
	19	555	74.17	8040	1.10	<b>FR 68 AM90</b> <b>FR 68 B5T2</b>	<b>90S-4 B14a</b> <b>90S-4 B5T2</b>
	20	525	69.75	8370	1.15		
	23	460	61.26	8920	1.30		
	25	425	56.89	9160	1.40		
	27	385	51.56	9420	1.55		
	30	345	46.29	9650	1.75		
	35	300	39.88	9890	1.95		
	37	280	37.50	9970	2.00		
	43	240	32.27	10100	2.20		
	49	215	28.83	10200	2.40		
	50	210	28.13	10200	2.60		
	52	200	26.72	10100	2.70		
60	176	23.44	9730	3.20			
70	149	19.89	9270	4.00			



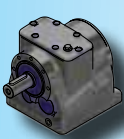

$P_{1n}$ [kW]	$N_2$ $\text{min}^{-1}$	$M_{2n}$ [Nm]	$i$	$F_{r2}$ [N]	$f_s$			
<b>1.5</b>	73	196	19.31	2660	1.00	<b>FR 38 AM90</b> <b>FR 38 B5T1</b>	<b>90L-4 B14a</b> <b>90L-4 B5T1</b>	
	78	183	18.05	2840	1.10			
	90	159	15.60	3160	1.25			
	106	135	13.25	3350	1.40			
	119	120	11.83	3270	1.50			
	140	103	10.11	3160	1.65			
	149	96	9.47	3110	1.75			
	177	81	7.97	2980	1.95			
	211	68	6.67	2820	2.10			
	249	58	5.67	2710	2.50			
	279	51	5.06	2630	2.60			
	326	44	4.32	2520	2.90			
	348	41	4.05	2470	3.00			
	414	35	3.41	2360	3.20			
		47	305	29.88	4220	1.00	<b>FR 48 AM90</b> <b>FR 48 B5T2</b>	<b>90L-4 B14a</b> <b>90L-4 B5T2</b>
		53	270	26.70	4140	1.10		
		60	240	23.59	4050	1.25		
		61	235	23.28	4040	1.25		
		65	220	21.81	3990	1.35		
		73	196	19.27	3890	1.50		
		79	182	17.89	3830	1.60		
		87	165	16.22	3740	1.65		
		97	148	14.56	3650	1.80		
		112	127	12.54	3520	1.95		
		120	120	11.79	3470	2.10		
		139	103	10.15	3340	2.20		
		155	92	9.07	3240	2.40		
		176	81	8.01	3140	2.50		
		182	79	7.76	3060	2.10		
		203	71	6.96	2980	2.30		
		235	61	6.00	2860	2.60		
		250	57	5.64	2810	2.70		
		291	49	4.85	2700	3.00		
		325	44	4.34	2610	3.30		
		368	39	3.83	2520	3.70		
		25	580	56.89	7810	1.05		
	27	525	51.56	8370	1.15			
	30	470	46.29	8830	1.30			
	35	405	39.88	9300	1.45			
	38	380	37.50	9460	1.50			
	44	330	32.27	9750	1.65			
	49	295	28.83	9920	1.80			
	50	285	28.13	9950	1.90			
	53	270	26.72	9850	2.00			
	60	240	23.44	9500	2.40			
	71	200	19.89	9070	3.00			
	79	182	17.95	8810	3.20			

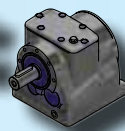

$P_{1n}$ [kW]	$N_2$ $\text{min}^{-1}$	$M_{2n}$ [Nm]	$i$	$F_{r2}$ [N]	$f_s$		
<b>2.2</b>	119	176	11.83	1990	1.05	<b>FR 38 AM100</b> <b>FR 38 B5T1</b>	<b>100L1-4 B14a</b> <b>100L1-4 B5T1</b>
	140	151	10.11	2360	1.15		
	149	141	9.47	2480	1.20		
	177	119	7.97	2750	1.30		
	211	99	6.67	2470	1.45		
	249	84	5.67	2570	1.70		
	279	75	5.06	2500	1.80		
	326	64	4.32	2410	1.95		
	348	60	4.05	2370	2.00		
	414	51	3.41	2270	2.20		
	73	285	19.27	3550	1.05	<b>FR 48 AM100</b> <b>FR 48 B5T2</b>	<b>100L1-4 B14a</b> <b>100L1-4 B5T2</b>
	87	240	16.22	3460	1.15		
	97	215	14.56	3400	1.20		
	112	187	12.54	3310	1.35		
	120	176	11.79	3270	1.40		
	139	151	10.15	3160	1.50		
	155	135	9.07	3090	1.65		
	176	119	8.01	3000	1.70		
	182	116	7.76	2910	1.40		
	203	104	6.96	2840	1.55		
	235	89	6.00	2740	1.75		
	250	84	5.64	2700	1.85		
	291	72	4.85	2600	2.10		
	325	65	4.34	2530	2.30		
	368	57	3.83	2440	2.50		
	35	595	39.88	7630	1.00	<b>FR 68 AM100</b> <b>FR 68 B5T2</b>	<b>100L1-4 B14a</b> <b>100L1-4 B5T2</b>
	38	560	37.50	8020	1.00		
	44	480	32.27	8750	1.10		
	49	430	28.83	9140	1.20		
	60	350	23.44	9140	1.60		
	71	295	19.89	8760	2.00		
	79	270	17.95	8530	2.20		
	89	235	15.79	8240	2.40		
95	220	14.91	8110	2.50			
111	189	12.70	7760	2.80			
122	172	11.54	7560	2.90			
141	149	10.00	7250	3.20			
162	130	8.70	6960	3.40			
181	116	7.79	6760	3.30			



$P_{1n}$ [kW]	$N_2$ $\text{min}^{-1}$	$M_{2n}$ [Nm]	$i$	$F_{r2}$ [N]	$f_s$		
<b>3.0</b>	210	137	6.67	1250	1.05	<b>FR 38 AM100</b> <b>FR 38 B5T1</b>	<b>100L2-4 B14a</b> <b>100L2-4 B5T1</b>
	247	116	5.67	1630	1.25		
	277	104	5.06	1830	1.30		
	324	88	4.32	2070	1.45		
	346	83	4.05	2140	1.45		
	411	70	3.41	2180	1.60		
	119	240	11.79	3040	1.00	<b>FR 48 AM100</b> <b>FR 48 B5T2</b>	<b>100L2-4 B14a</b> <b>100L2-4 B5T2</b>
	138	210	10.15	2970	1.10		
	154	186	9.07	2910	1.20		
	175	164	8.01	2840	1.25		
	181	159	7.76	2740	1.05		
	201	143	6.96	2680	1.10		
	233	123	6.00	2610	1.25		
	248	115	5.64	2580	1.35		
	288	99	4.85	2490	1.50		
	323	89	4.34	2430	1.65		
	365	78	3.83	2360	1.85		
	60	480	23.44	8730	1.15	<b>FR 68 AM100</b> <b>FR 68 B5T2</b>	<b>100L2-4 B14a</b> <b>100L2-4 B5T2</b>
70	405	19.89	8420	1.45			
78	365	17.95	8230	1.60			
89	325	15.79	7980	1.75			
94	305	14.91	7860	1.80			
110	260	12.70	7550	2.00			
121	235	11.54	7360	2.10			
140	205	10.00	7090	2.30			
<b>4.0</b>	252	152	5.64	2410	1.00	<b>FR 48 AM112</b> <b>FR 48 B5T2</b>	<b>112M-4 B14a</b> <b>112M-4 B5T2</b>
	293	131	4.85	2350	1.15		
	327	117	4.34	2300	1.25		
	371	103	3.83	2250	1.40		
	71	535	19.89	7960	1.10	<b>FR 68 AM112</b> <b>FR 68 B5T2</b>	<b>112M-4 B14a</b> <b>112M-4 B5T2</b>
	79	485	17.95	7800	1.20		
	90	425	15.79	7600	1.30		
	95	400	14.91	7510	1.35		
	112	340	12.70	7240	1.50		
	123	310	11.54	7080	1.60		
	142	270	10.00	6840	1.75		
	163	235	8.70	6600	1.90		
	182	210	7.79	6440	1.80		
	193	198	7.36	6340	1.85		
	227	169	6.27	6070	1.95		
	249	153	5.70	5920	2.00		
	288	133	4.93	5680	2.20		
	331	116	4.29	5460	2.30		

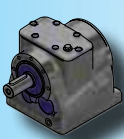

$P_{1n}$ [kW]	$N_2$ $\text{min}^{-1}$	$M_{2n}$ [Nm]	$i$	$F_{r2}$ [N]	$f_s$		
<b>5.5</b>	373	141	3.83	2080	1.00	<b>FR 48 AM - FR 48 B5T2</b>	<b>132S-4 B14a - 132S-4 B5T2</b>
	96	550	14.91	6900	1.00		
	113	465	12.70	6810	1.10		
	124	425	11.54	6690	1.20		
	143	365	10.00	6500	1.30		
	164	320	8.70	6310	1.40		
	183	285	7.79	6180	1.35		
	194	270	7.36	6100	1.35		
	228	230	6.27	5860	1.45		
	251	210	5.70	5720	1.50		
	290	181	4.93	5510	1.60		
	333	158	4.29	5310	1.70	<b>FR 68 AM132</b> <b>FR 68 B5T2</b>	<b>132S-4 B14a</b> <b>132S-4 B5T2</b>
<b>7.5</b>	164	435	8.70	5930	1.00		
	194	370	7.36	5720	1.00		
	228	315	6.27	5600	1.05		
	251	285	5.70	5480	1.10		
	290	245	4.93	5300	1.15		
	333	215	4.29	5130	1.25	<b>FR 68 AM132</b> <b>FR 68 B5T2</b>	<b>132M-4 B14a</b> <b>132M-4 B5T2</b>

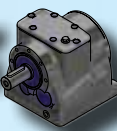

The FR 38 can be supplied with an integrated motor (B5T1) as well as with an IEC motor adaptor (AM)  
The B5T1 version is meant to be assembled with a special motor, made with a non IEC flange and a shouldered shaft.  
The AM version can be assembled with a standard motor with flange and shaft according to IEC.

**FR 38 B5T1**

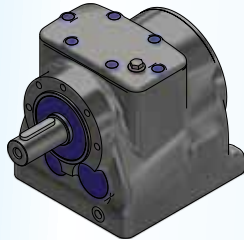

**FR 38 AM..**

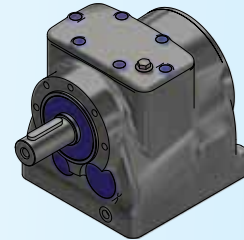

**FR 38 B5T1**

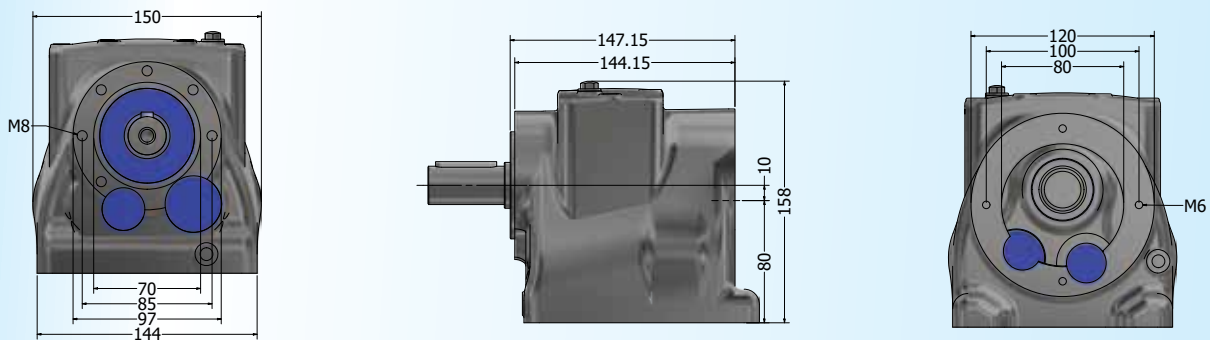

**FR 38 B5T1 Footprint & output shaft**

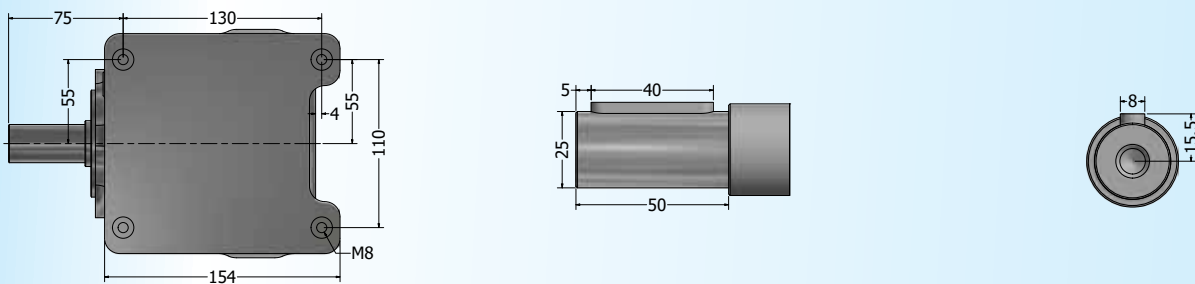

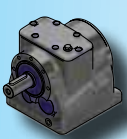

The FR 38 can be supplied with an integrated motor (B5T1) as well as with an IEC motor adaptor (AM)  
The B5T1 version is meant to be assembled with a special motor, made with a non IEC flange and a shouldered shaft.  
The AM version can be assembled with a standard motor with flange and shaft according to IEC.

**FR 38 B5T1**

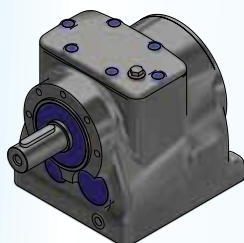

**FR 38 AM..**

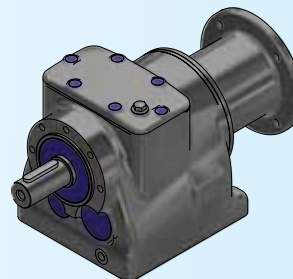

**FR 38 AM**

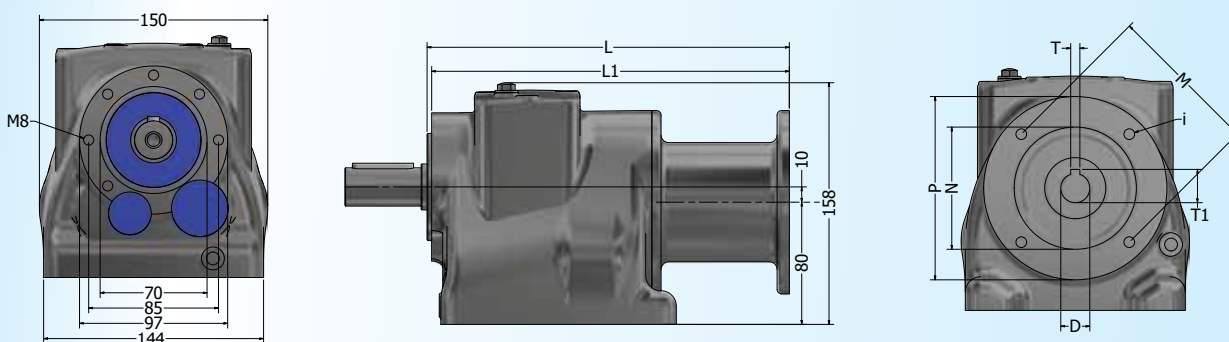

**FR 38 AM Footprint & output shaft**

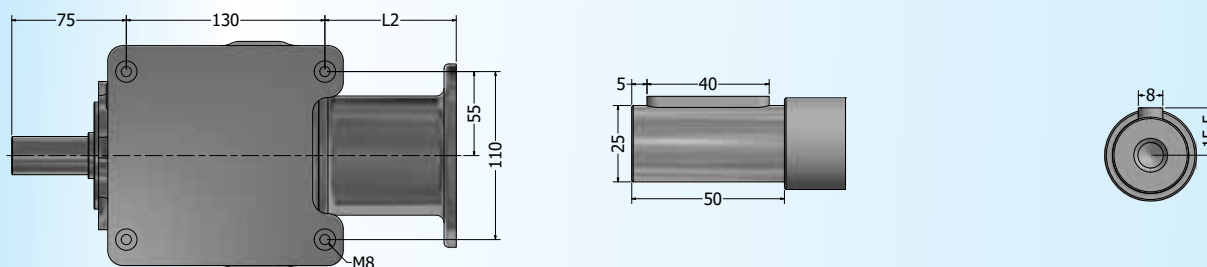

Gearbox	Motor type	D	T	T1	i	M	N	P	L	L1	L2
FR 38 AM63	IEC63 B5	11	4	12.8	9	115	95	140	237.15	234.15	86
FR 38 AM71	IEC71 B5	14	5	16.3	9	130	110	160	237.15	234.15	86
FR 38 AM80	IEC80 B14A	19	6	21.8	7	100	80	120	237.15	234.15	86
FR 38 AM90	IEC90 B14A	24	8	27.3	9	115	95	140	237.15	234.15	86
FR 38 AM100	IEC100 B14A	28	8	31.3	9	130	110	160	237.15	234.15	86
FR 38 AM112	IEC112 B14A	28	8	31.3	9	130	110	160	237.15	234.15	86



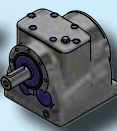

The FR 48 can be supplied with an integrated motor (B5T2) as well as with an IEC motor adaptor (AM)  
The B5T2 version is meant to be assembled with a special motor, made with a non IEC flange and a shouldered shaft.  
The AM version can be assembled with a standard motor with flange and shaft according to IEC.

**FR 48 B5T2**

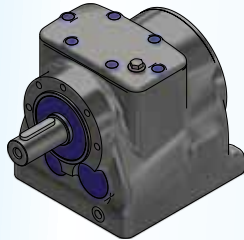

**FR 48 AM..**

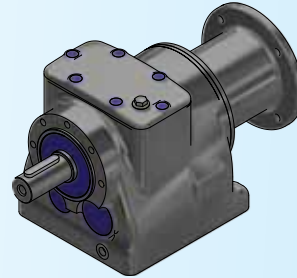

**FR 48 B5T2**

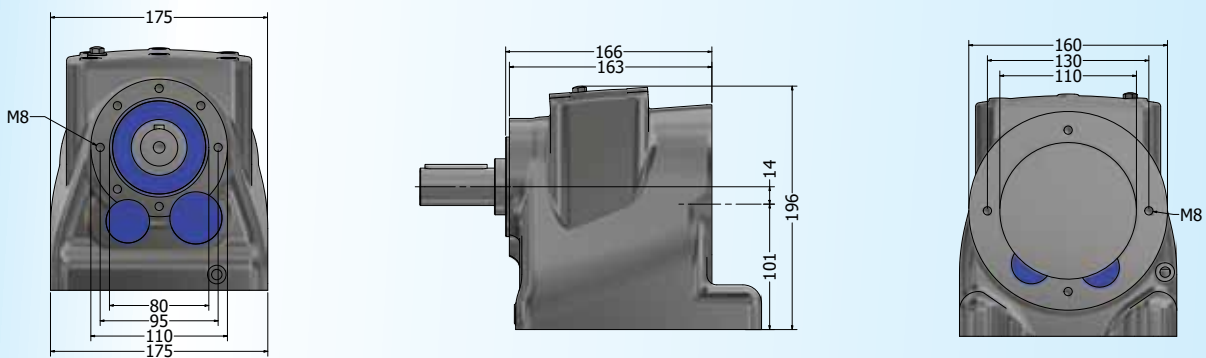

**FR 48 B5T2 Footprint & output shaft**

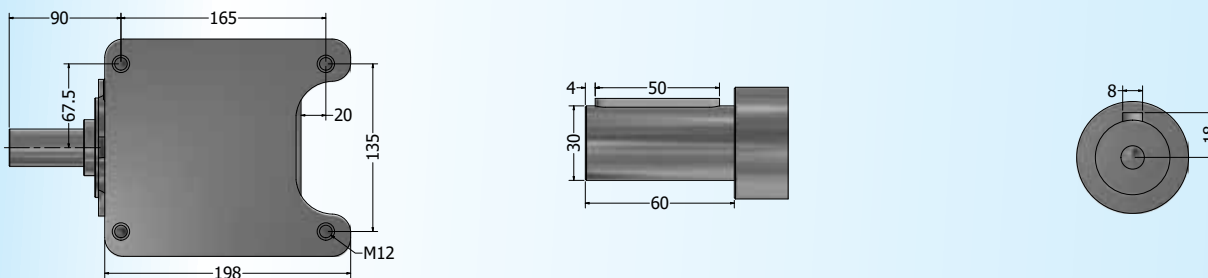

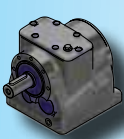

The FR 48 can be supplied with an integrated motor (B5T2) as well as with an IEC motor adaptor (AM)  
The B5T2 version is meant to be assembled with a special motor, made with a non IEC flange and a shouldered shaft.  
The AM version can be assembled with a standard motor with flange and shaft according to IEC.

**FR 48 B5T2**

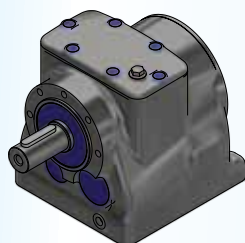

**FR 48 AM..**

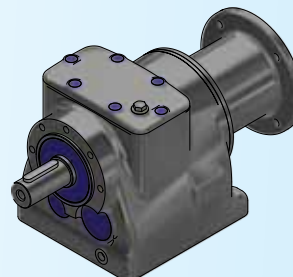

**FR 48 AM**

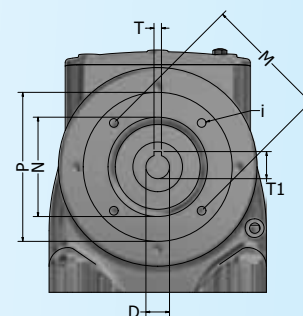
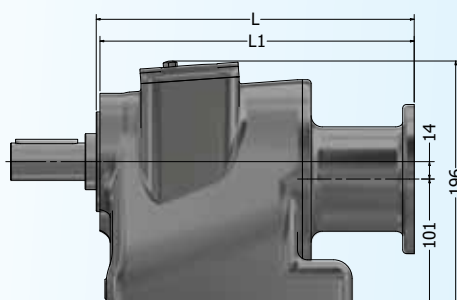
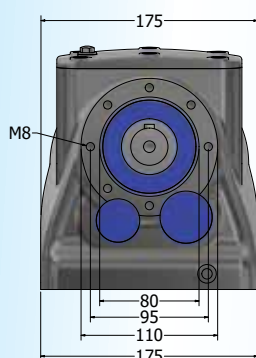

**FR 48 AM Footprint & output shaft**

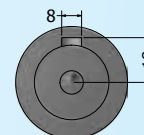
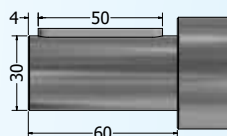
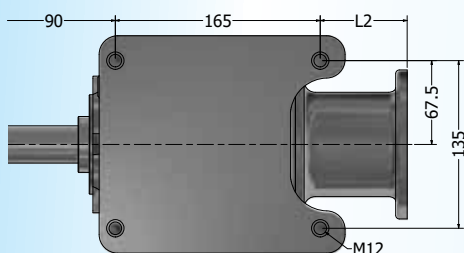

Gearbox	Motor type	D	T	T1	i	M	N	P	L	L1	L2
FR 48 AM63	IEC63 B5	11	4	12.8	9	115	95	140	256	253	70
FR 48 AM71	IEC71 B5	14	5	16.3	9	130	110	160	256	253	70
FR 48 AM80	IEC80 B14A	19	6	21.8	7	100	80	120	256	253	70
FR 48 AM90	IEC90 B14A	24	8	27.3	9	115	95	140	256	253	70
FR 48 AM100	IEC100 B14A	28	8	31.3	9	130	110	160	256	253	70
FR 48 AM112	IEC112 B14A	28	8	31.3	9	130	110	160	256	253	70

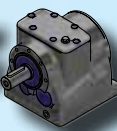

The FR 68 can be supplied with an integrated motor (B5T2) as well as with an IEC motor adaptor (AM)  
The B5T2 version is meant to be assembled with a special motor, made with a non IEC flange and a shouldered shaft.  
The AM version can be assembled with a standard motor with flange and shaft according to IEC.

**FR 68 B5T2**

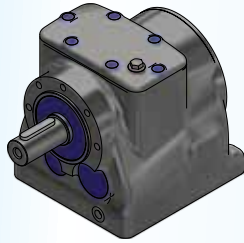

**FR 68 AM..**

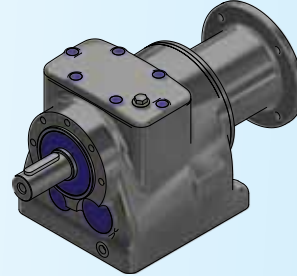

**FR 68 B5T2**

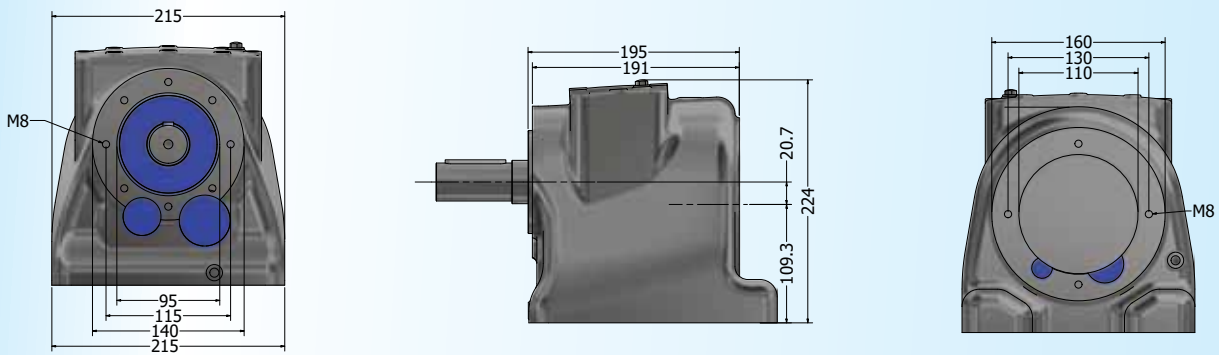

**FR 68 B5T2 Footprint & output shaft**

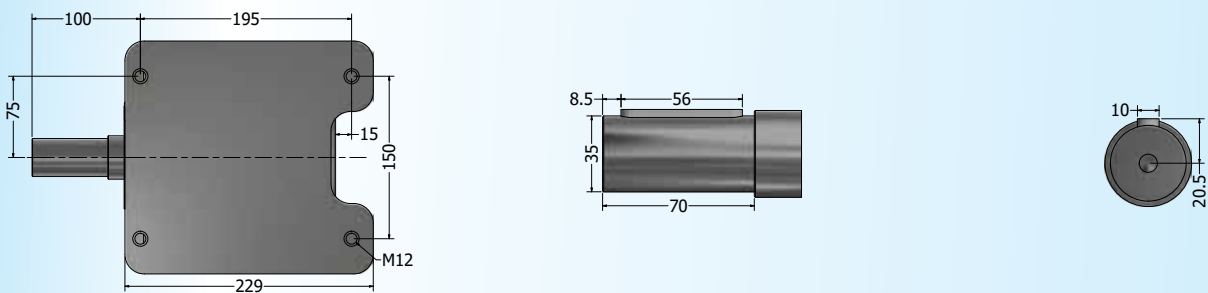

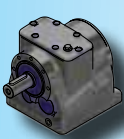

The FR 68 can be supplied with an integrated motor (B5T2) as well as with an IEC motor adaptor (AM)  
The B5T2 version is meant to be assembled with a special motor, made with a non IEC flange and a shouldered shaft.  
The AM version can be assembled with a standard motor with flange and shaft according to IEC.

**FR 68 B5T2**

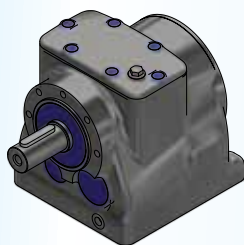

**FR 68 AM..**

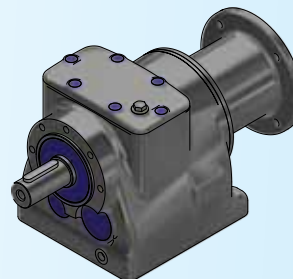

**FR 68 AM**

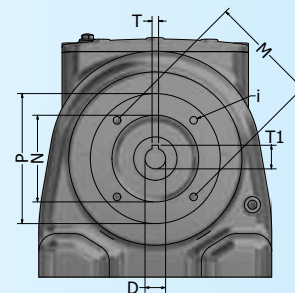
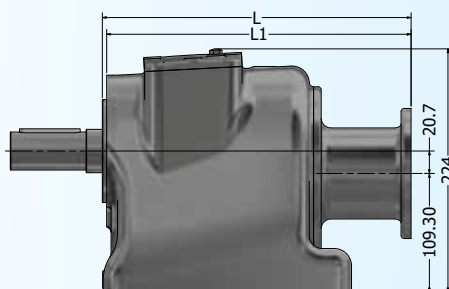
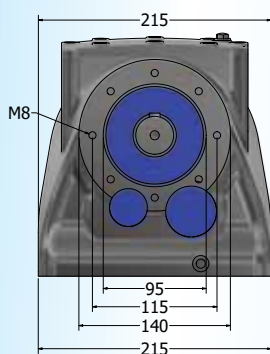

**FR 68 AM Footprint & output shaft**

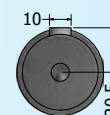
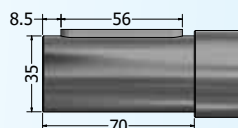
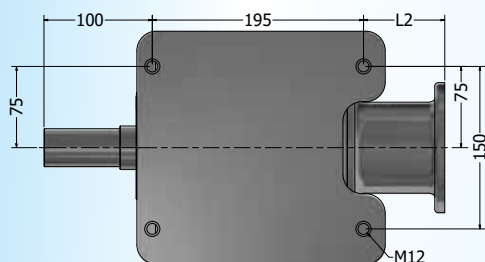

Gearbox	Motor type	D	T	T1	i	M	N	P	L	L1	L2
FR 68 AM63	IEC63 B5	11	4	12.8	9	115	95	140	285	281	70
FR 68 AM71	IEC71 B5	14	5	16.3	9	130	110	160	285	281	70
FR 68 AM80	IEC80 B14A	19	6	21.8	7	100	80	120	285	281	70
FR 68 AM90	IEC90 B14A	24	8	27.3	9	115	95	140	285	281	70
FR 68 AM100	IEC100 B14A	28	8	31.3	9	130	110	160	285	281	70
FR 68 AM112	IEC112 B14A	28	8	31.3	9	130	110	160	285	281	70
FR 68 AM132	IEC132 B14A	38	10	41.3	11	165	130	200	321	317	106

### Mounting Positions

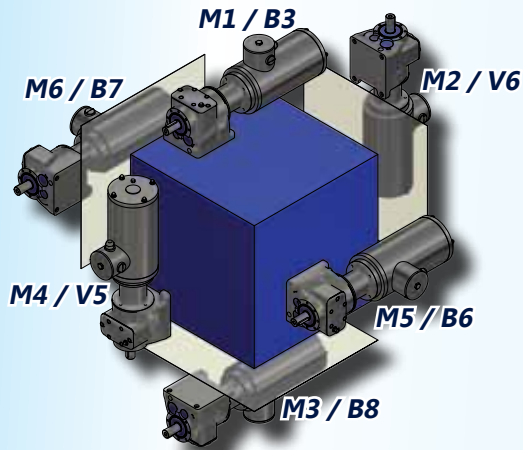

### Terminal Box Positions

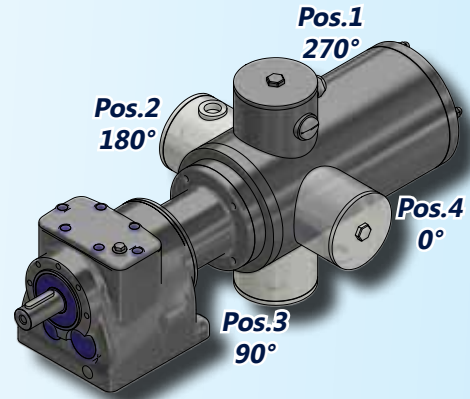

### Lubrication Quantity

Oil Quantity in ML.	Mounting Position					
	M1 (B3)	M3 (B8)	M6 (B7)	M5 (B6)	M4 (V5)	M2 (V6)
FR 38 B5T1 / AM..	1000	1000	1000	1000	1200	1000
FR 48 B5T2 / AM..	2000	1800	1900	1400	2300	2400
FR 68 B5T2 / AM..	3250	2900	3000	2700	3600	3300

### Lubrication Type

Gearbox	Oil Type	Temp. Range
FR 38 FR 48 FR 68	Matrix Foodmax 460	-20°C ~ +40°C
	Castrol Optileb GT 460	-20°C ~ +40°C
	Bechem Berusynth 460 H1	-20°C ~ +40°C
	Shell Casida Fluid GL460	-20°C ~ +40°C
	Mobil SHC Cibus 460	-20°C ~ +40°C

### Weight

Gearbox	Weight	Gearbox	Weight
FR 38 B5T1	9.0 Kg.	FR 38 AM..	12.5 Kg.
FR 48 B5T2	15 Kg.	FR 48 AM..	19 Kg.
FR 68 B5T2	22.5 Kg.	FR 68 AM..	27 Kg.

### Maintenance

For maintenance instructions  
please see our maintenance manual on page .....

### Positioning of the debreather

