

Serie Medium

SR475MI/SR475ME Nylon Cable Chain with openable frames

Inner height (D) 75,5 mm

Sideband & Frame construction with large anti-friction single-pin. Frames are openable from inner radius (SR475MI) or from outer radius (SR475ME). Vertical and horizontal modular separator system is available.

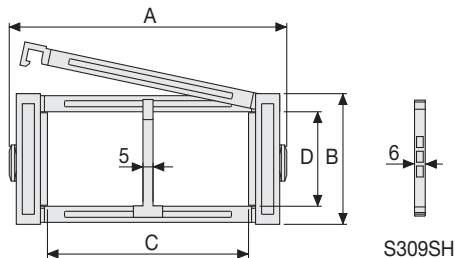

Separator

- Unassembled Part.no S309S
- Assembled Part.no S309SMC

Strong-hold separator

for C > 250 mm

- Unassembled Part.no S309HOFL
- Assembled Part.no S309HOFLMC

Pin

Part.no PG475

Technical characteristics when self-supported

Speed	8 m/s
Acceleration	40 m/s ²

For higher requirements please consult our technical dept.

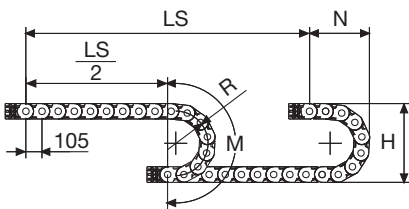

Length of chain (L)

Half travel distance ($\frac{LS}{2}$) plus length of curve (M)

$$L = \frac{LS}{2} + M$$

R	H	N	M
mm	mm	mm	mm
150	400,5	310	690
180	460,5	335	775
200	500,5	355	840
250	600,5	405	995
300	700,5	460	1155
350	800,5	505	1310
400	900,5	560	1470

A	B	C	D	R	Weight/m	Chain
mm	mm	mm	mm	mm	kg	Part Number
112	100,5	74	75,5	150-180-200-250-300-350-400	3,70	SR475MI(ME)074□□□*
132	100,5	94	75,5	150-180-200-250-300-350-400	3,80	SR475MI(ME)094□□□*
157	100,5	119	75,5	150-180-200-250-300-350-400	3,85	SR475MI(ME)119□□□*
164	100,5	126	75,5	150-180-200-250-300-350-400	3,90	SR475MI(ME)126□□□*
187	100,5	149	75,5	150-180-200-250-300-350-400	3,95	SR475MI(ME)149□□□*
227	100,5	189	75,5	150-180-200-250-300-350-400	4,05	SR475MI(ME)189□□□*
262	100,5	224	75,5	150-180-200-250-300-350-400	4,15	SR475MI(ME)224□□□*
288	100,5	250	75,5	150-180-200-250-300-350-400	4,25	SR475MI(ME)250□□□*
312	100,5	274	75,5	150-180-200-250-300-350-400	4,30	SR475MI(ME)274□□□*
338	100,5	300	75,5	150-180-200-250-300-350-400	4,37	SR475MI(ME)300□□□*
362	100,5	324	75,5	150-180-200-250-300-350-400	4,45	SR475MI(ME)324□□□*
388	100,5	350	75,5	150-180-200-250-300-350-400	4,55	SR475MI(ME)350□□□*
412	100,5	374	75,5	150-180-200-250-300-350-400	4,60	SR475MI(ME)374□□□*
467	100,5	429	75,5	150-180-200-250-300-350-400	4,80	SR475MI(ME)429□□□*
536	100,5	498	75,5	150-180-200-250-300-350-400	5,00	SR475MI(ME)498□□□*

*Complete the code by inserting the value of the radius (R): Ex. SR475MI(ME)119 □ □ □ □
Chain equipped with nylon frame every pitch: complete the code by inserting the letter D.
Ex. SR475MI(ME)119150 □ □



Self-Supporting Capacity Diagram

The maximum length of the self-supporting capacity ($\frac{LS}{2}$) in relationship to the weight of the cables and hoses contained per linear metre.

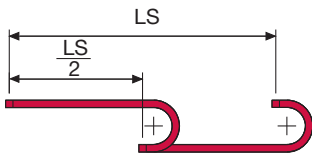
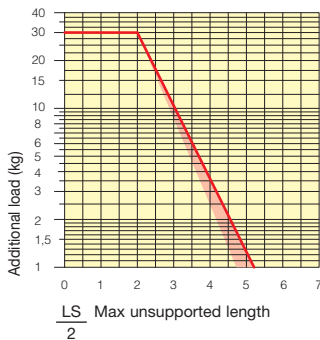

The red marking in the diagram area considers the difference of weight between various widths of chains assembled with nylon frames every second pitch.

For applications with $\frac{LS}{2}$ and weights not included in the area of the diagram showing self-supporting capacity, verify the possible use of support rollers (see page 30).

Bright Zinc Plated Steel End Brackets***

The end brackets set allows the two ends of the chain to be attached to the equipment. Set complete with tiewrap clamps available on request.

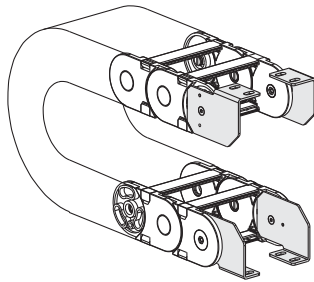
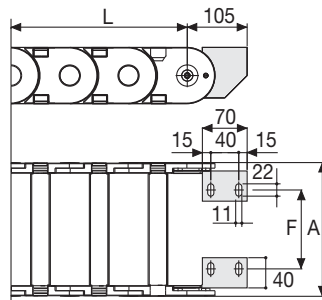

Fig. A
Chain fixed outside the radius. (Fig A)
See end brackets mounting variations page 31.



Chain Type	F mm
SR475MI(ME)074	35
SR475MI(ME)094	55
SR475MI(ME)119	80
SR475MI(ME)126	87
SR475MI(ME)149	110
SR475MI(ME)189	150
SR475MI(ME)224	185
SR475MI(ME)250	211
SR475MI(ME)274	235
SR475MI(ME)300	261
SR475MI(ME)324	285
SR475MI(ME)350	311
SR475MI(ME)374	335
SR475MI(ME)429	390
SR475MI(ME)498	459

Bright Zinc Plated Steel Type Part Numbers

Complete Set Assembled	Chain	End Brackets
Type	Set	Set
SR475...	A475M□□□*KM	□**

Complete Set Unassembled	Chain	End Brackets
Type	Set	Set
SR475...	A475M□□□*K	□**

Tiewrap Clamp
Assembl. CFC475M □□□*KM
Unassembl. CFC475M □□□*K

* Inner width (C)
** 1=Pos.1; 2=Pos.2; 3=Pos.3
*** Available on request in stainless steel

Serie Medium

SR475MI SR475ME

Nylon Cable Chain
with openable frames

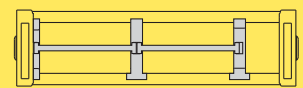

Separation System
To choose the separators see page. 184

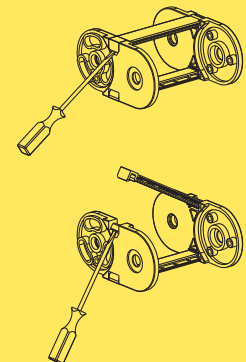

How to open the cover.

For further information please consult Brevetti Stendalto's Technical Office